

DOE-HDBK-1015/2-93
JANUARY 1993



DOE FUNDAMENTALS HANDBOOK

CHEMISTRY

Volume 2 of 2



U.S. Department of Energy
Washington, D.C. 20585

FSC-6910

Distribution Statement A. Approved for public release; distribution is unlimited.

This document has been reproduced directly from the best available copy.

Available to DOE and DOE contractors from the Office of Scientific and Technical Information. P.O. Box 62, Oak Ridge, TN 37831.

Available to the public from the National Technical Information Services, U.S. Department of Commerce, 5285 Port Royal., Springfield, VA 22161.

Order No. DE93012222

DOE-HDBK-1015/2-93
CHEMISTRY

ABSTRACT

The *Chemistry Handbook* was developed to assist nuclear facility operating contractors in providing operators, maintenance personnel, and the technical staff with the necessary fundamentals training to ensure a basic understanding of chemistry. The handbook includes information on the atomic structure of matter; chemical bonding; chemical equations; chemical interactions involved with corrosion processes; water chemistry control, including the principles of water treatment; the hazards of chemicals and gases, and basic gaseous diffusion processes. This information will provide personnel with a foundation for understanding the chemical properties of materials and the way these properties can impose limitations on the operation of equipment and systems.

Key Words: Training Material, Atomic Structure of Matter, The Periodic Table of the Elements, Chemical Bonding, Corrosion, Water Chemistry Control, Water Treatment Principles, Chemical Hazards, Gaseous Diffusion Processes

DOE-HDBK-1015/2-93
CHEMISTRY

FOREWORD

The *Department of Energy (DOE) Fundamentals Handbooks* consist of ten academic subjects, which include Mathematics; Classical Physics; Thermodynamics, Heat Transfer, and Fluid Flow; Instrumentation and Control; Electrical Science; Material Science; Mechanical Science; Chemistry; Engineering Symbolology, Prints, and Drawings; and Nuclear Physics and Reactor Theory. The handbooks are provided as an aid to DOE nuclear facility contractors.

These handbooks were first published as Reactor Operator Fundamentals Manuals in 1985 for use by DOE category A reactors. The subject areas, subject matter content, and level of detail of the Reactor Operator Fundamentals Manuals were determined from several sources. DOE Category A reactor training managers determined which materials should be included, and served as a primary reference in the initial development phase. Training guidelines from the commercial nuclear power industry, results of job and task analyses, and independent input from contractors and operations-oriented personnel were all considered and included to some degree in developing the text material and learning objectives.

The *DOE Fundamentals Handbooks* represent the needs of various DOE nuclear facilities' fundamental training requirements. To increase their applicability to nonreactor nuclear facilities, the Reactor Operator Fundamentals Manual learning objectives were distributed to the Nuclear Facility Training Coordination Program Steering Committee for review and comment. To update their reactor-specific content, DOE Category A reactor training managers also reviewed and commented on the content. On the basis of feedback from these sources, information that applied to two or more DOE nuclear facilities was considered generic and was included. The final draft of each of the handbooks was then reviewed by these two groups. This approach has resulted in revised modular handbooks that contain sufficient detail such that each facility may adjust the content to fit their specific needs.

Each handbook contains an abstract, a foreword, an overview, learning objectives, and text material, and is divided into modules so that content and order may be modified by individual DOE contractors to suit their specific training needs. Each handbook is supported by a separate examination bank with an answer key.

The *DOE Fundamentals Handbooks* have been prepared for the Assistant Secretary for Nuclear Energy, Office of Nuclear Safety Policy and Standards, by the DOE Training Coordination Program. This program is managed by EG&G Idaho, Inc.

DOE-HDBK-1015/2-93
CHEMISTRY

OVERVIEW

The *Department of Energy Fundamentals Handbook* entitled *Chemistry* was prepared as an information resource for personnel who are responsible for the operation of the Department's nuclear facilities. An understanding of chemistry will enable contractor personnel to understand the intent of the chemical concerns within their facility. A basic understanding of chemistry is necessary for DOE nuclear facility operators, maintenance personnel, and the technical staff to safely operate and maintain the facility and facility support systems. The information in the handbook is presented to provide a foundation for applying engineering concepts to the job. This knowledge will help personnel understand the impact that their actions may have on the safe and reliable operation of facility components and systems.

The *Chemistry* handbook consists of five modules that are contained in two volumes. The following is a brief description of the information presented in each module of the handbook.

Volume 1 of 2

Module 1 - Fundamentals of Chemistry

Introduces concepts on the atomic structure of matter. Discusses the periodic table and the significance of the information in a periodic table. Explains chemical bonding, the laws of chemistry, and chemical equations.

Appendix A - Basic Separation Theory

Introduces basic separation theory for the gaseous diffusion process. Discusses converter construction and basic operating principals.

Module 2 - Corrosion

Supplies basic information on the chemical interaction taking place during the corrosion process between the environment and the corroding metal.

DOE-HDBK-1015/2-93
CHEMISTRY

OVERVIEW (Cont.)

Volume 2 of 2

Module 3 - Reactor Water Chemistry

Describes the chemical measures taken to retard the corrosion often found in water systems. The consequences of radioactivity on facility cooling water systems are also addressed.

Module 4 - Principles of Water Treatment

Details the principles of ion exchange in the context of water purity. Discusses typical water treatment methods and the basis for these methods.

Module 5 - Hazards of Chemicals and Gases

Explains why certain chemicals are considered hazardous to facility personnel. Includes general safety rules on handling and storage.

The information contained in this handbook is by no means all encompassing. An attempt to present the entire subject of chemistry would be impractical. However, the *Chemistry Handbook* does present enough information to provide the reader with a fundamental knowledge level sufficient to understand the advanced theoretical concepts presented in other subject areas, and to better understand basic system and equipment operation.

**Department of Energy
Fundamentals Handbook**

**CHEMISTRY
Module 3
Reactor Water Chemistry**

TABLE OF CONTENTS

LIST OF FIGURES	ii
LIST OF TABLES	iii
REFERENCES	iv
OBJECTIVES	v
EFFECTS OF RADIATION ON WATER CHEMISTRY (SYNTHESIS)	1
Interaction of Radiation	1
Summary	11
CHEMISTRY PARAMETERS	12
Specific Parameters	12
pH	14
Dissolved Oxygen	15
Hydrogen	16
Total Gas	18
Conductivity	19
Chlorides	21
Fluorine	22
Radioactivity	23
Tritium	23
Abnormal Chemistry Conditions	25
Injection of Air	25
Fuel Element Failure	28
Resin Overheating	28
Summary	30

LIST OF FIGURES

Figure 1	Change in pH, Gas Concentration, and Nitrogen Compounds With Excess Oxygen Added	8
Figure 2	Corrosion Rate vs. pH for Iron	14
Figure 3	Pressurizer	18
Figure 4	pH and Conductivity as a Function of NH ₃ Concentration	19
Figure 5	Theoretical Conductivity as a Function of pH	20
Figure 6	Facility Start-up with Air in Loop	27

LIST OF TABLES

Table 1	Summary of Reactor Coolant Chemistry Control	13
Table 2	Hydrogen Isotopes	24

REFERENCES

- Donald H. Andrews and Richard J. Kokes, Fundamental Chemistry, John Wiley & Sons, Inc., 1963
- Compressed Gas Association, Inc., Handbook of Compressed Gases, 2nd Edition, Reinhold Publishing Corporation, 1981.
- R. A. Day, Jr. and R. C. Johnson, General Chemistry, Prentice Hall, Inc., 1974.
- Dickerson, Gray, Darensbourg and Darensbourg, Chemical Principles, 4th Edition, The Benjamin Cummings Publishing Company, 1984.
- Academic Program for Nuclear Plant Personnel, Volume II, Chemistry, Columbia, MD, General Physics Corporation, Library of Congress Card #A 326517, 1972.
- General Physics Corporation, Fundamentals of Chemistry, General Physics Corporation, 1982.
- Glasstone and Sesonske, Nuclear Reactor Engineering, 3rd Edition, Van Nostrand Reinhold Company, 1981.
- McElroy, Accident Prevention Manual for Industrial Operations Engineering and Technology, Volume 2, 8th Edition, National Safety Council, 1980.
- Sienko and Plane, Chemical Principles and Properties, 2nd Edition, McGraw and Hill, 1974.
- Underwood, Chemistry for Colleges and Schools, 2nd Edition, Edward Arnold, Ltd., 1967.
- Norman V. Steere and Associates, CRC Handbook of Laboratory Safety, 2nd Edition, CRC Press, Inc., 1971.

TERMINAL OBJECTIVE

- 1.0 Without references, **DESCRIBE** the effects of radiation on reactor water and methods of treatment for the products.

ENABLING OBJECTIVES

- 1.1 **DESCRIBE** the process of radiolytic decomposition and recombination of water.
- 1.2 **DESCRIBE** the process of radiolytic decomposition and recombination of nitric acid and ammonia.
- 1.3 **STATE** the advantage of maintaining excess hydrogen in reactor water.
- 1.4 **STATE** the three sources of radioactivity in reactor water and each one's decay product.
- 1.5 **STATE** the following for reactor water chemistry.
- a. Nine parameters controlled
 - b. Reason for controlling each parameter
 - c. Method of controlling each parameter
- 1.6 **STATE** the possible effects of abnormal chemistry on core conditions.

Intentionally Left Blank

EFFECTS OF RADIATION ON WATER CHEMISTRY (SYNTHESIS)

Radiation synthesis is a process that takes place in the reactor coolant system. This phenomenon is limited to the reactor coolant system because of the high flux (radiation) levels that exist in the core region and further complicate chemistry control of the reactor plant.

- EO 1.1** **DESCRIBE the process of radiolytic decomposition and recombination of water.**
- EO 1.2** **DESCRIBE the process of radiolytic decomposition and recombination of nitric acid and ammonia.**
- EO 1.3** **STATE the advantage of maintaining excess hydrogen in reactor water.**
- EO 1.4** **STATE the three sources of radioactivity in reactor water and each one's decay product.**
-

Interaction of Radiation

As reactor coolant water passes through the core region of an operating reactor, it is exposed to intense radiation. The major components of the radiation field are neutrons, protons, gamma rays, and high energy electrons (beta particles). These types of radiation interact with the coolant water primarily by an ionization process and have a marked effect on the water itself and on the chemical reactions between substances dissolved in the water. This section discusses these effects, and in particular the effects that involve gases dissolved in reactor coolant.

The interaction of radiation with matter produces ion pairs. Usually, the negative member of the ion pair is a free electron and the positive member is a polyatomic cation, the exact nature of which depends on the particular substance being irradiated. For example, the interaction of radiation with water is illustrated by the following reaction.

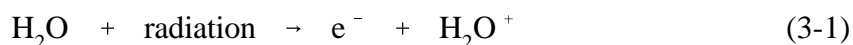

Both of these species are very reactive chemically, and there are several reaction pathways available to each. Some of these mechanisms are very complex and are usually of little practical value to the reactor operator, who is more concerned with the overall, observable effects. In the case of water, the overall effect of irradiation is shown in the following reaction.

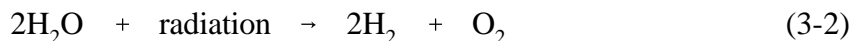

Because this result is not at all apparent from Reaction (3-1), the following section describes the intermediate processes in some detail. This discussion is presented only to illustrate the types of reaction mechanisms that occur in irradiated solutions. Subsequent discussions primarily involve only the overall effects of these processes.

Reaction (3-1) shows that irradiation of pure water produces an electron and a H_2O^+ ion. As stated, both species are highly reactive. The H_2O^+ ion rapidly reacts with a water molecule as follows.

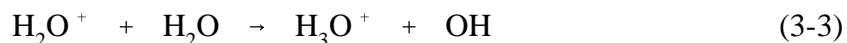

The species OH is an uncharged hydroxyl group. Neutral groups such as this, in which all chemical bonding capacity is not satisfied, are common intermediate species in chemical reactions and are called radicals or sometimes free radicals.

The electron produced by Reaction (3-1) first forms a species called the hydrated electron, denoted by e_{aq}^- . The hydrated electron may be thought of as resulting from the interaction of a negative electron with the positive end of a polar water molecule. This is analogous to the formation of hydronium ions by interaction of a positive proton (H^+) with the negative end of a water molecule. Because the water molecules associated with hydrated electrons do not participate in subsequent chemical reactions, they are not shown in chemical equations, and the hydrated electron (e_{aq}^-) is used instead.

Hydrated electrons may interact with H_3O^+ ions in solution or with water molecules. Both reactions produce another reactive species, atomic hydrogen.

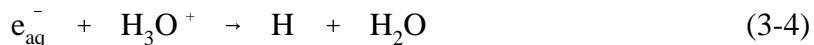

or

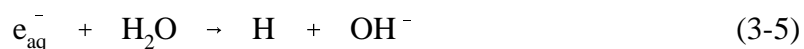

Reaction (3-4) usually predominates.

Because Reactions (3-4) and (3-5) are slow compared to that in Reaction (3-3), there are three reactive species present at any one time: hydroxyl radicals (OH), hydrated electrons (e_{aq}^-), and hydrogen atoms (H). These species may undergo any of several possible reactions such as the following.



Hydrogen peroxide, formed by Reaction (3-6), may also react with the original reactive species, but at high temperatures H_2O_2 is unstable, and the predominant reaction is decomposition.

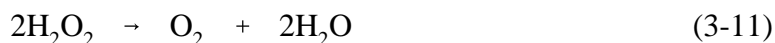

To illustrate the overall result of these reactions, let us assume that each of the reactive species produced by successive steps in the irradiation of water reacts in only one way. That is, whenever several reactions of a particular substance are possible, assume that one predominates to such an extent that the others are negligible. The following set of reactions is one possibility. In some cases, entire reactions are multiplied by a factor to allow cancellation of terms when the reactions are summed.

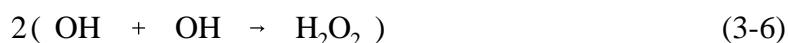
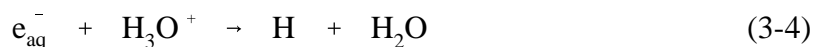
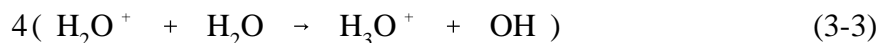
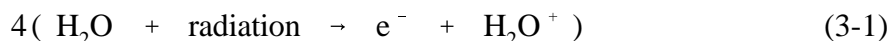



or

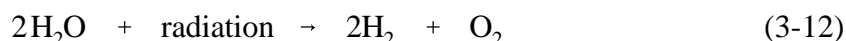

The net result of these reactions is simply the decomposition of water. If H_2 and O_2 are allowed to escape from solution as gases, the reaction continues as written. If, however, the water is contained in a closed system under pressure (as in a reactor coolant system), H_2 and O_2 are confined, and an equilibrium state is reached because radiation also causes the reverse of Reaction (3-2) to take place. Primarily neutron and gamma radiation induce both the decomposition of water and the recombination of H_2 and O_2 to form water. Thus, it is appropriate to write Reaction (3-2) as a radiation-induced equilibrium reaction.

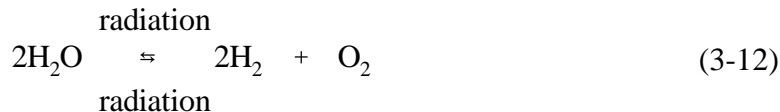

To arrive at the overall effect of radiation on water, the above process involved the assumption that only one reaction pathway is available to each reactive species. This was done primarily for convenience because inclusion of every possible reaction in the summation process becomes rather cumbersome. Even if all the reactions are taken into account, the net result is the same as Reaction (3-12), which is reasonable because inspection of Reactions (3-3) through (3-11) shows that the only stable products are H_2 , O_2 , and H_2O (H_3O^+ and OH^- combine to form water, and H_2O_2 decomposes at high temperature). Perhaps not as obvious, more water is consumed than is produced in these reactions, and the net result is the initial decomposition of water that proceeds until equilibrium concentrations of H_2 and O_2 are established.

Before discussing the effects of radiation on other processes, chemical equilibrium in the presence of ionizing radiation should be mentioned. Equilibrium processes in aqueous solutions are discussed briefly in Module 1, which states that temperature influences the equilibrium. Ionizing radiation also influences the equilibrium of these solutions.

Radiation has an effect on the equilibrium in the case of water. In the absence of radiation, water does not spontaneously decompose at 500°F and the equilibrium lies far to the right.

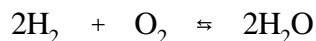

When irradiated, however, water does decompose, as shown above. Also, H_2 and O_2 do not normally react at 500°F because a large activation energy is required to make the reaction occur. Radiation, in effect, supplies this activation energy, and the reaction takes place readily. Thus, radiation increases the rates of both forward and reverse reactions, although not by the same factor.

In general, the effect of radiation on the equilibrium for a given reaction cannot be predicted quantitatively. The situation is further complicated by the observation that the effect on the equilibrium may vary with the intensity of the radiation. In nuclear facilities, the effect may vary with the power level of the facility. In most cases, this complication is not a severe problem because the direction of the effect is the same; only the degree or magnitude of the effect varies with the intensity of the radiation.

As noted several times previously, reactor coolant is maintained at a basic pH (in facilities other than those with aluminum components or those that use chemical shim reactivity control) to reduce corrosion processes. It is also important to exclude dissolved oxygen from reactor coolant for the same reason. As shown in the preceding section, however, a natural consequence of exposing pure water to ionizing radiation is production of both hydrogen and oxygen. The addition of a base to control pH has essentially no effect on this feature.

To prevent the formation of oxygen in reactor coolant, hydrogen is added. Hydrogen suppresses the formation of oxygen primarily by its effect on the reactions that OH radicals, produced by Reaction (3-3), undergo. In the presence of excess hydrogen, hydroxyl radicals react predominantly by Reaction (3-10) rather than as in Reactions (3-6) through (3-8).



Hydrogen atoms from this equation subsequently react to form H_2 and H_2O by Reactions (3-7), (3-8), and (3-9). None of these reactions leads to O_2 , or H_2O_2 , which decomposes to form O_2 and H_2O at high temperatures. Thus, the addition of H_2 to reactor coolant largely eliminates production of free oxygen.

Another way of viewing the effect of hydrogen on reactor coolant is through its effect on the equilibrium of the reaction.

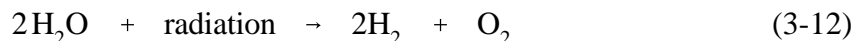

By LeChatelier's principle, the addition of excess hydrogen forces the equilibrium to the left, which requires that O_2 be consumed. If the dissolved hydrogen concentration is sufficiently large, only a very small amount of oxygen will be present at equilibrium. Normally, therefore, reactor coolant contains excess dissolved hydrogen, and there is no significant net decomposition of water by radiation.

Reactor coolant makeup water usually contains a small amount of air, which is composed primarily of nitrogen and oxygen in a volume ratio of 4:1 (80 percent nitrogen, 20 percent oxygen). These gases undergo radiation-induced reactions. The reactions are the same as those that occur in certain accident situations and are included in the following discussion.

In addition to the small amount of air normally dissolved in makeup water, there is a small possibility that air may be accidentally injected directly into the reactor coolant system.

Whenever air enters the reactor coolant system, and the reactor is operating, the most immediate reaction involves oxygen from the air and hydrogen, which is normally present in the coolant.



That is, the addition of O_2 disturbs the above equilibrium and causes the equilibrium to shift to the right, consuming both H_2 and O_2 . The concentration of hydrogen normally maintained in reactor coolant is such that small amounts of oxygen will be rapidly consumed before any excess oxygen can cause severe corrosion problems to occur.

Reaction (3-13) also consumes oxygen added to the reactor coolant as a natural consequence of air dissolved in makeup water. Other than initial fill of the reactor coolant system, the situations that require the largest amounts of makeup water are feed and bleed operations to correct an abnormal chemistry parameter or cooldown after some period of reactor operation. In this case, gamma radiation from the decay of fission products in the reactor core continues to induce the $\text{H}_2 - \text{O}_2$ reaction for some period after shutdown. During initial fill and long shutdown periods, chemicals other than hydrogen (e.g. hydrazine) may be added to reactor coolant to remove any dissolved oxygen.

After essentially all of the oxygen has been consumed by reaction with hydrogen, the nitrogen contained in air will remain. For small air additions, some hydrogen will also remain; thus, the reactor coolant will contain both dissolved hydrogen and dissolved nitrogen. These two gases do not react in an unirradiated solution at low temperature and pressure. When exposed to radiation, however, the gases do react by the following reaction.

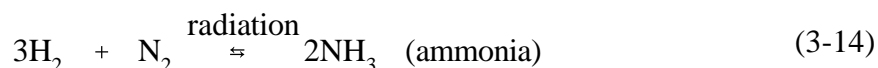

Again, this is an equilibrium reaction, and radiation induces the reaction in both directions. Ammonia (NH_3) produced by this reaction combines with water to form ammonium hydroxide (NH_4OH).

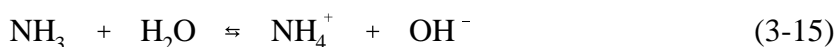

Under the operating conditions of reactor coolant, Reaction (3-14) is far from complete. In most cases, less than about 10 percent of the nitrogen will be converted to ammonia. If no additional base were added to reactor coolant, Reaction (3-14) would be sufficient to cause the coolant to be mildly basic, pH 9. In the presence of added base, however, the reaction has only a very slight and negligible effect on pH.

If the base NH_3 were used to control reactor coolant pH, the reverse of Reaction (3-14) would be more important. The reverse step of this reaction requires that some of the ammonia added to the coolant decompose into N_2 and H_2 . Because operating conditions favor this step of the equilibrium, rather than formation of NH_3 , it would be expected that most of the ammonia added would decompose. However, the rate of the ammonia decomposition reaction is slow, and the pH of reactor coolant can be maintained in the required range. It should also be noted that the decomposition of NH_3 would produce hydrogen gas in significant concentrations in reactor coolant (sufficient to satisfy normal H_2 requirements).

In the event that a large quantity of air is injected into the reactor coolant system, the inventory of dissolved hydrogen would be rapidly depleted by Reaction (3-13). If the amount of air injected is sufficiently large, there could be oxygen remaining in the coolant after depletion of the hydrogen. In this case, another reaction is available to the oxygen and nitrogen in the air.

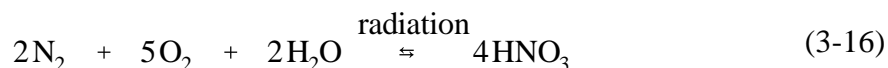

Nitric acid (HNO_3) produced by this reaction will neutralize any base contained in the coolant, and if sufficient acid is produced, the coolant will acquire an acidic pH.

Normally, the amount of hydrogen maintained in the reactor coolant, in conjunction with other precautions employed, greatly reduces the probability that the amount of oxygen entering the coolant will be sufficient to lead to Reaction (3-16). If a large amount of air were accidentally added to the reactor coolant, one solution would be to add more hydrogen. The added hydrogen would react with remaining oxygen, disrupting the equilibrium of Reaction (3-16) causing the reverse step of that reaction to occur. When all the oxygen has been removed, H_2 and N_2 could react by Reaction (3-14) and help reestablish a basic pH. The relationship between these reactions and pH following the initial oxygen addition, and a subsequent hydrogen addition, is illustrated in Figure 1.

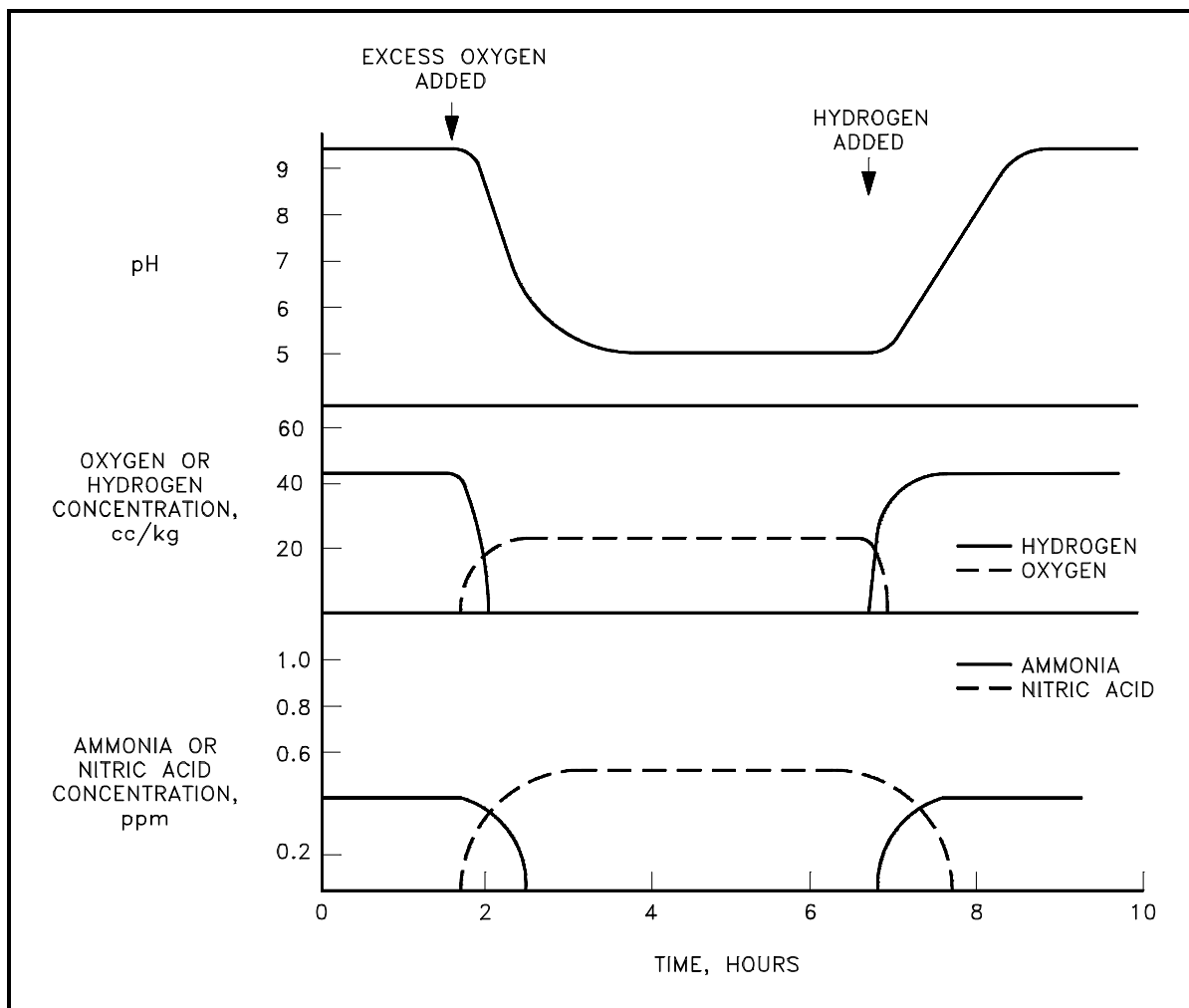

Figure 1 Change in pH, Gas Concentration, and Nitrogen Compounds
With Excess Oxygen Added

In the preceding discussion, the reactions possible after the addition of air to reactor coolant containing hydrogen were described. These are Reactions (3-13), (3-14), and (3-16). The relative rates of these reactions are of considerable importance. Briefly, Reaction (3-13) is much more rapid than either of the others, and Reaction (3-16) is faster than Reaction (3-14). Thus, the sequence of reactions is as described in the preceding sections. H₂ and O₂ react to form water. If hydrogen remains, it undergoes an incomplete reaction with N₂ to form small amounts of NH₃. If O₂ remains after all the H₂ has been consumed, the O₂ - N₂ reaction produces nitric acid.

The flux of neutrons and protons in a nuclear reactor core region leads to several important nuclear reactions with the constituent atoms of water. Most of these reactions involve oxygen isotopes and fast neutrons or protons.

In many cases, the absorption of a fast neutron by a nucleus is immediately followed by ejection of a proton. These reactions are called neutron-proton or n-p reactions and are commonly written (using the ¹⁶O reaction to illustrate) in the following manner.



In this notation, the original isotope that undergoes the reaction is written first, the product isotope is last, and the two are separated by, in order, the particle absorbed and the particle emitted. The isotope ¹⁶N decays to ¹⁶O with a 7.13-second half-life by emitting a beta particle (β⁻) and a high-energy gamma ray (6 Mev predominantly).

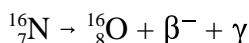

Oxygen-17 undergoes a similar reaction.

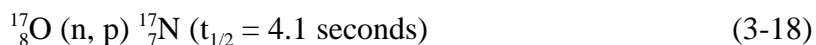

The isotope ¹⁷N decays by emission of a beta particle, a neutron, and a gamma ray.

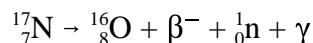

Reactions (3-17) and (3-18) have no significant chemical effect on reactor coolant because of the relatively small number of atoms that undergo these reactions. They are of considerable importance, however, because the radioactive species ¹⁶N and ¹⁷N are carried outside the core region by the flow of reactor coolant. The neutrons and high-energy gamma rays emitted by these isotopes easily penetrate the piping and components that contain the coolant and are important considerations in the design of shielding for nuclear facilities. Because the half-lives of these isotopes are very short, they decay to low levels very rapidly after shutdown and are, therefore, of little concern during such periods.

Two other nuclear reactions with oxygen isotopes are shown below.

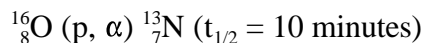
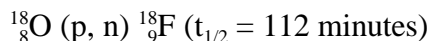

An ejected alpha particle is indicated by α . The protons that cause these reactions result from inelastic collisions of fast neutrons with hydrogen atoms in water molecules. The radioactivity levels of these isotopes are much lower than the levels of $^{16}_7\text{N}$ and $^{17}_7\text{N}$ during reactor facility operation. However, during the period from a few minutes to about five hours after reactor shutdown or after removing a coolant sample from the system, $^{13}_7\text{N}$ and $^{18}_9\text{F}$ are the principal sources of radioactivity in the reactor coolant of most reactor facilities.

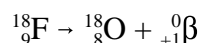
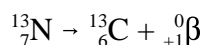

The only significant nuclear reaction that occurs with hydrogen involves deuterium (^2_1H), which comprises about 0.015 percent of natural hydrogen.

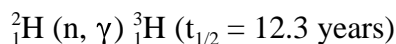

Tritium (^3_1H) decays by emission of a very weak β particle (0.02 Mev) and no gamma rays. Thus, tritium is not a radiological hazard unless it enters the body in significant amounts. Tritium can enter the body through inhalation or ingestion. It is also possible to absorb forms of tritium through the skin.

Summary

The important information in this chapter is summarized below.

Effects of Radiation on Water Chemistry (Synthesis) Summary

- The intense radiation inside the core of an operating nuclear reactor produces several chemical effects on the reactor coolant itself and on substances dissolved in the coolant. Radiation causes pure water to decompose into H₂ and O₂. The decomposition is suppressed by adding excess hydrogen.

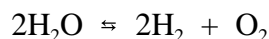

- Excess hydrogen is added to suppress the decomposition of reactor water. It also reacts with any oxygen that enters the reactor coolant system, usually as a component of air in makeup water, provided the amount of oxygen is not excessive. If the amount of oxygen is more than enough to deplete the hydrogen, the excess oxygen reacts with nitrogen (also a component of air) and forms nitric acid. In the case of addition of very large amounts of air, the amount of nitric acid produced may be more than enough to neutralize the normally basic coolant and cause it to become acidic.
- Radiation induces the combination of N₂ and H₂ to form ammonia, although the extent of this reaction is small and usually has a negligible effect on the pH of reactor coolant. All of the reactions in this chapter are reversible and reach an equilibrium state under normal operating conditions. Changes in the concentrations of any of the reactants disturb the equilibrium and causes the reaction to shift in the direction which restores the equilibrium.

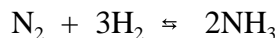

- Radiation also produces several nuclear reactions in reactor coolant. The products ¹⁶₇N and ¹⁷₇N, of two of these reactions, contribute radioactivity to the reactor coolant, adding significantly to the shielding requirements for nuclear reactors. Others, ¹³₇N and ¹⁸₉F, are also major contributors to the radioactivity in reactor coolant.

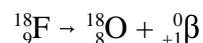
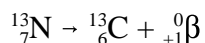
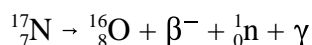
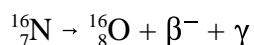

CHEMISTRY PARAMETERS

The reasons for control of selected chemistry parameters, and some of the more common methods of controlling these parameters will be discussed. No attempt will be made to identify specific values of any of the parameters discussed because of the number of different reactor facilities involved, but an overview concerning the bases and common methods used will be included. For operating values and specifications, users should refer to local facility publications. In addition, some information on tritium is provided.

EO 1.5 STATE the following for reactor water chemistry.

- a. Nine parameters controlled**
- b. Reason for controlling each parameter**
- c. Method of controlling each parameter**

EO 1.6 STATE the possible effects of abnormal chemistry on core conditions.

Specific Parameters

Specific chemical parameters vary from facility to facility but generally include the following: pH, dissolved oxygen, hydrogen, total gas content, conductivity, chlorides, fluorine, boron, and radioactivity. For the parameters indicated, control is generally achieved by one or more of three basic processes.

- (1) Ion exchange in the primary system demineralizer(s) or by supplemental chemical additions
- (2) Oxygen scavenging by hydrogen or hydrazine addition
- (3) Degassification

Table 1 lists the more common chemistry parameters measured and/or controlled, the reasons each is measured and/or controlled, and control methods utilized.

TABLE 1
Summary of Reactor Coolant Chemistry Control

Parameter	Reason	Method of Control
pH	<ul style="list-style-type: none"> To inhibit corrosion To protect corrosion film To preclude caustic stress corrosion 	<ul style="list-style-type: none"> Ion exchange Ammonium hydroxide addition Nitric acid addition
Dissolved Oxygen	<ul style="list-style-type: none"> To inhibit corrosion 	<ul style="list-style-type: none"> Hydrogen addition Hydrazine addition
Hydrogen	<ul style="list-style-type: none"> To scavenge oxygen To suppress radiolytic decomposition of water To scavenge nitrogen To preclude hydrogen embrittlement 	<ul style="list-style-type: none"> Hydrogen addition Degassification
Total Gas Content	<ul style="list-style-type: none"> To protect pumps To indicate air in leakage 	<ul style="list-style-type: none"> Degassification Deaeration of makeup water
Conductivity	<ul style="list-style-type: none"> To minimize scale formation To indicate increased corrosion 	<ul style="list-style-type: none"> Ion exchange Feed and Bleed
Chlorides	<ul style="list-style-type: none"> To preclude chloride stress corrosion 	<ul style="list-style-type: none"> Ion exchange Feed and bleed
Fluorine	<ul style="list-style-type: none"> To preclude corrosion of Zr cladding 	<ul style="list-style-type: none"> Ion exchange Feed and Bleed
Boron	<ul style="list-style-type: none"> To control reactivity 	<ul style="list-style-type: none"> Boric acid addition
Radioactivity	<ul style="list-style-type: none"> To indicate increased corrosion To indicate a crud burst To indicate a core fuel defect To monitor effectiveness of demineralizer 	<ul style="list-style-type: none"> Ion exchange Feed and bleed

pH

The reason for controlling pH in the reactor coolant system is to minimize and control corrosion. As discussed in Module 1, the presence of excess H^+ ions in solution results in an acidic condition. In reactor facilities (except those containing aluminum components), acidic conditions are detrimental to the materials of construction in a number of ways. An acidic condition in the primary coolant results in processes that are potentially harmful to the system as follows. First, a low pH promotes rapid corrosion by deteriorating or "stripping off" the protective corrosion film, and second, corrosion products such as ferrous oxide (Fe_3O_4), which is predominant in the corrosion film, are highly soluble in an acidic solution. Figure 2 shows how the corrosion rate increases as the pH decreases. Thus for facilities not using aluminum components, a neutral or highly basic pH is less corrosive.

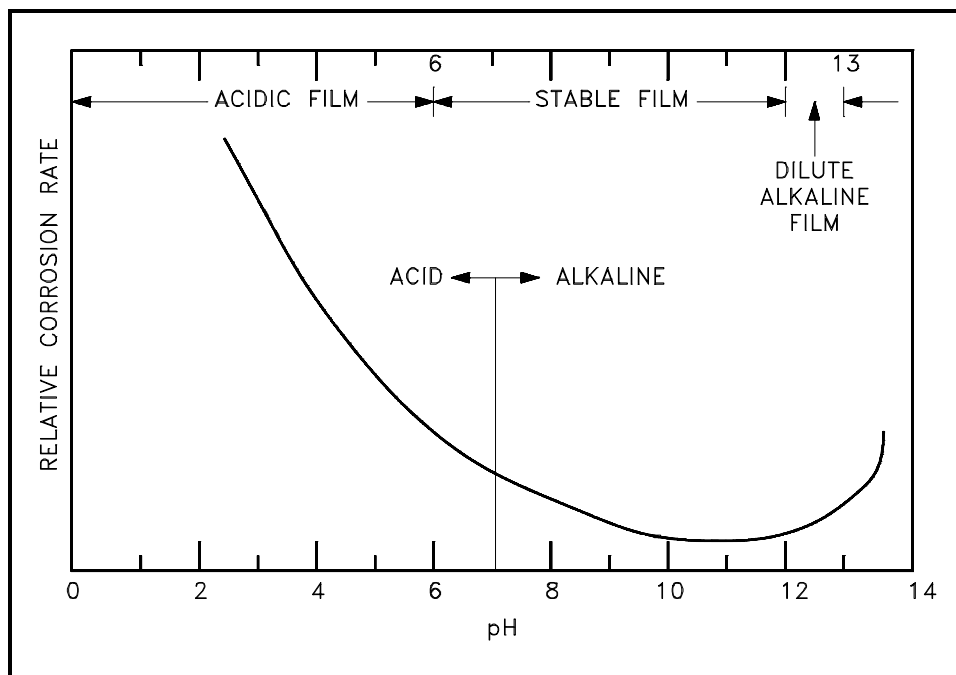

Figure 2 Corrosion Rate vs. pH for Iron

In nuclear facilities that do not use chemical shim to control reactivity, pH is normally maintained at a relatively high value, such as a pH of about 10. In these facilities the upper limit for pH is set based on caustic stress corrosion considerations because caustic stress corrosion becomes more probable as higher pH values are approached.

In facilities that use chemical shim reactivity control (chemical shim involves the addition of boron in the form of boric acid) the pH is maintained at a much lower value. A low pH is necessary because of the large amounts of boric acid added to the reactor coolant. Accordingly, pH in these facilities is maintained as high as possible consistent with the reactivity requirements of the nuclear facility, with pH range from 5 to 7 being common.

In facilities using aluminum components, pH is maintained on the acidic side of the scale because of the corrosion characteristics of aluminum discussed in Module 2. In these facilities pH may be controlled by the addition of a dilute nitric acid (HNO₃) solution to the reactor coolant system in conjunction with an ion exchange system of some type.

Regardless of the pH range maintained, most facilities use an ion exchange process (described in Module 4) to help control pH. For the high pH facilities, the most common means of control is the use of a lithium or an ammonium form cation and a hydroxyl form anion. When lithium is used, it must be ⁷Li because other lithium isotopes produce tritium, which represents a significant biological hazard to personnel. In facilities that employ high pH chemistry control and do not use chemical shim reactivity control, it is sometimes necessary to add a strong base solution such as ammonium or lithium hydroxide. When chemical additions are used for pH control, facility design and operating procedures are utilized to preclude overconcentration at any point in the system, which may lead to caustic stress corrosion conditions. Many reactions that take place in the reactor coolant system can affect pH; therefore chemistry control must be considered carefully to preclude upsetting the pH balance provided by the ion exchanger.

Dissolved Oxygen

Control of the dissolved oxygen content in the reactor facility system is of paramount importance because of its contribution to increased corrosion. The base reactions of concern regarding high concentrations of dissolved oxygen are the following.



They are dependent on both the concentration of oxygen and temperature. Reaction (3-19) is predominant at high temperatures (>400°F) in the presence of lower oxygen concentrations. This corrosion film, ferrous oxide, is also known as magnetite and is a black, generally tightly-adherent film that provides a protective function to surfaces within the facility. Reaction (3-20) occurs at temperatures below about 400°F in the presence of higher oxygen concentrations. Ferric oxide (Fe₂O₃) is more commonly known as rust and is generally a reddish color. This corrosion product adheres loosely to surfaces and is therefore easily removed and transported throughout the system for subsequent deposition and possible irradiation. In either of the reactions, the corrosion rate is accelerated by increased concentrations of dissolved O₂ and can be aggravated further by the presence of other substances that may be present in the system.

In addition to the direct contribution to corrosion, oxygen reacts with nitrogen to lower the pH of the reactor water, which also results in an increased rate of corrosion. Oxygen and nitrogen react to form nitric acid by the following reaction.

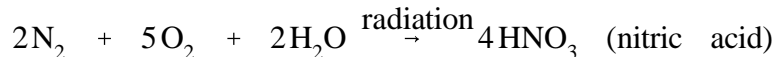

In all the reactions presented, it can be seen that oxygen concentrations promote corrosion. It follows then that if corrosion is to be minimized, oxygen concentrations must be maintained as low as possible. In most nuclear facility reactor coolant systems, the limit for dissolved oxygen concentrations is expressed in ppb (parts per billion). Concentration may be monitored on a continuous basis by using an in-line analyzing system or periodically by withdrawing a sample volume and analyzing that sample. Monitoring oxygen levels is done not only to ensure that no oxygen is available for corrosion, but also to indicate the introduction of air into the system.

Hydrogen

Because the presence of dissolved oxygen contributes to most mechanisms of corrosion, the concentration of oxygen is controlled and reduced by the addition of scavenging agents in most facilities. Hydrogen gas (H_2) and hydrazine (N_2H_4) are the scavenging agents normally used to eliminate dissolved oxygen from the reactor coolant system. These substances scavenge oxygen by the following reactions.

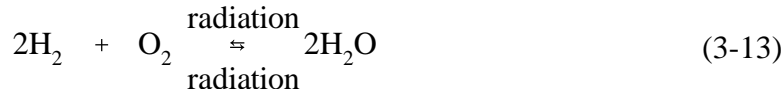

Because hydrazine decomposes rapidly at temperatures above about 200°F (forming NH_3 , H_2 , and N_2), hydrogen gas is used as the scavenging agent during hot operation and hydrazine is used when the reactor coolant system is cooled below 200°F.

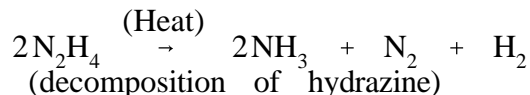

The decomposition reactions of hydrazine pose additional problems in chemistry control. Even if sufficient hydrazine were added to overcome the loss due to decomposition, instability of coolant pH would probably occur by the following reactions.



The use of hydrogen gas at temperatures above 200°F precludes the generation of the compounds formed by Reactions (3-16) and (3-22). In addition, hydrogen is compatible with the high flux levels present in the reactor core. Accordingly, advantage may be taken of the reversibility of the radiolytic decomposition of water. The following reaction illustrates the scavenging process utilizing hydrogen.

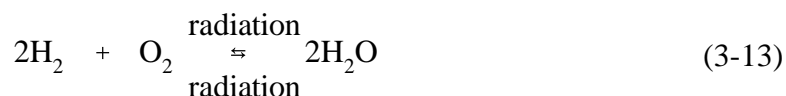

As indicated, the reaction is an equilibrium process and will therefore depend on the relative concentrations of the reactants and the products. By maintaining an excess of hydrogen (H_2), the reaction is forced to shift to the right and theoretically eliminates any dissolved oxygen that may be present. As long as an inventory of H_2 is present in the coolant, dissolved oxygen will be eliminated or forced to recombine immediately after radiolytic decomposition, thereby being unavailable for corrosion reactions.

A boiling water reactor (BWR) facility is susceptible to corrosion, resulting from dissolved oxygen, in the same reactions as are present in a pressurized water reactor (PWR). However, because of the design of these facilities the use of chemical additives is prohibited because continuous concentration would occur in the reactor vessel due to boiling. Boiling would result in a plating out process, and the irradiation of these concentrated additives or impurities would create an extreme environment of radiation levels as well as adverse corrosion locations.

By the very nature of operation of a BWR facility, the buildup of high concentrations of dissolved oxygen is prevented. Because boiling is occurring in the reactor vessel and the steam generated is used in various processes and subsequently condensed, removal of dissolved gases is a continual process. As stated, boiling is an effective means of removing gases from a solution. If we were to compare the oxygen content of the steam and the water in a BWR, we would find typical concentrations of 100 ppb to 300 ppb in the water and 10,000 ppb to 30,000 ppb in the steam. This concentration process is continuous during operation, and the dissolved oxygen remains in the gaseous state and is subsequently removed in the condensing units along with other noncondensable gases. As with PWR facilities, BWR facilities minimize the introduction of dissolved oxygen by pretreating makeup water by some method. The large oxygen concentrations measured in the steam system result primarily from the radiolysis of water according to Reaction (3-12), and as operation is continued, the equilibrium concentration of 100 ppb to 300 ppb is established. This concentration of oxygen is consistent with the objective of minimizing corrosion.

Total Gas

Total gas concentration in the reactor coolant system is another parameter of concern. Total gas is the sum of all gases contained in the coolant system and is made up primarily of hydrogen (H_2), nitrogen (N_2), argon (Ar), and oxygen (O_2). The small amounts of fission gases (Kr and Xe) normally present in the system may also contribute to the total gas concentration; however, under normal conditions these are essentially undetectable. Total gas is of concern because high concentrations can result in the formation of gas pockets in areas that are high points of the system where low or stagnant flow conditions exist. Of particular concern in PWR facilities are the erosion and corrosion that may occur on the impellers of the primary coolant pumps. As the concentration of gas is increased, the probability of the gas coming out of solution in significant amounts in areas of low pressure is also increased. This low pressure condition exists at the inlet to the primary coolant pump impeller (where centrifugal pumps are utilized). As these gas bubbles are forced back into solution on the high pressure side of the impeller, erosion can occur as a result of the gas bubble impinging on the impeller. In extreme concentrations of total gas, loss of pump priming and cavitation can occur with resultant mechanical pump damage.

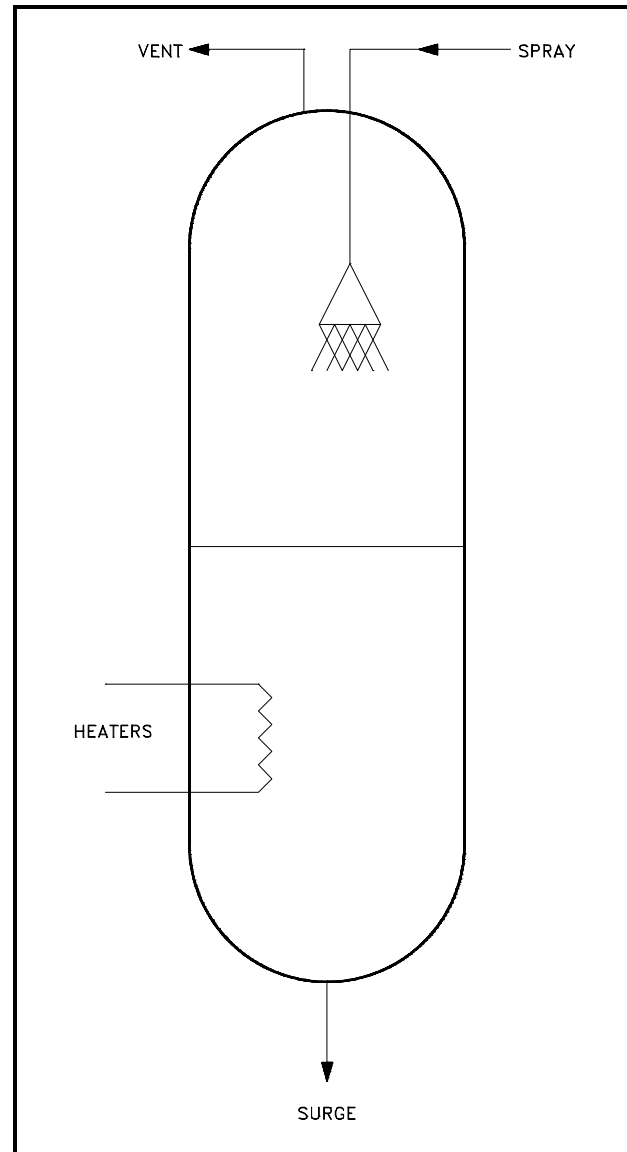

Figure 3 Pressurizer

Reduction of total gas concentrations in PWRs is normally accomplished by the venting of a steam space. In those facilities utilizing a pressurizer, the steam space in the top of the pressurizer is designed to accomplish this venting operation either continuously or intermittently. This process of reducing the total gas concentration is generally referred to as degassification. A typical PWR pressurizer with degassification piping is shown in Figure 3.

Degassification is not normally required in a BWR because of its design. As discussed previously, the boiling action in the reactor vessel strips dissolved gases from the water, and they are continuously removed in the condensing phase of the energy cycle.

Conductivity

Conductivity of reactor facility water is measured to provide an indication of dissolved ionic substances in the coolant. Conductivity measurements provide quantitative rather than qualitative information because it is possible to determine the total conductivity of the ions present, but not the specific types of ions present. Because many ions such as iron (Fe^{+++}), chromium (Cr^{+++}), copper (Cu^{++}) and aluminum (Al^{+++}) are susceptible to forming oxides and plating out as scale on heat transfer surfaces, reactor coolant conductivity is normally controlled at a level as low as practicable and consistent with pH. By monitoring conductivity levels in the reactor facility systems, the operator is able to cross check the chemistry of these systems, thereby achieving a higher confidence level in the parameters measured.

Regardless of the operating limits specified for a given reactor facility, operating relationships can be established between pH and conductivity levels of the coolant. Figure 4 shows a typical relationship of the pH and conductivity of a reactor coolant system using high pH, ammonium hydroxide chemistry control as a function of the ammonia (NH_3) concentration.

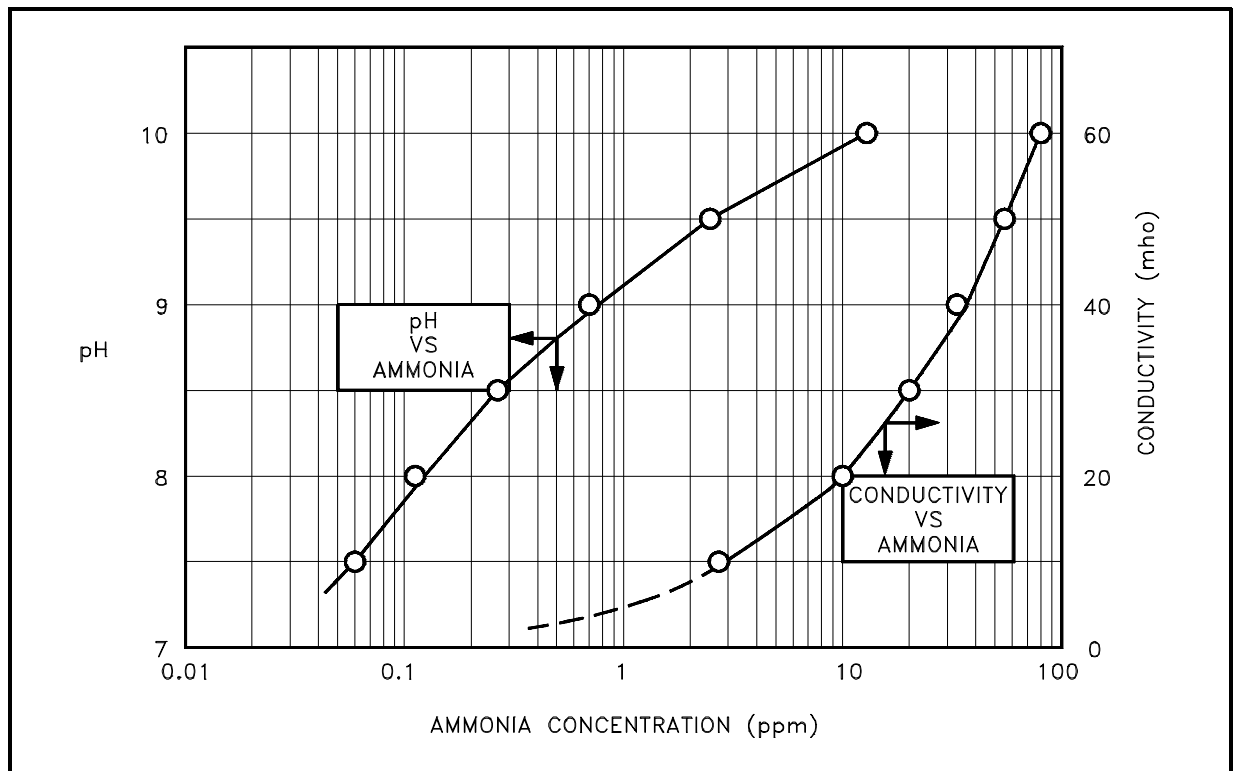

Figure 4 pH and Conductivity as a Function of NH_3 Concentration

Figure 5 shows the theoretical relationship of pH versus conductivity in a solution containing pure water. A second curve is added to the graph that illustrates the relationship that exists when nitric acid (HNO_3) is used as a pH control agent (such as may be utilized in facilities with aluminum components).

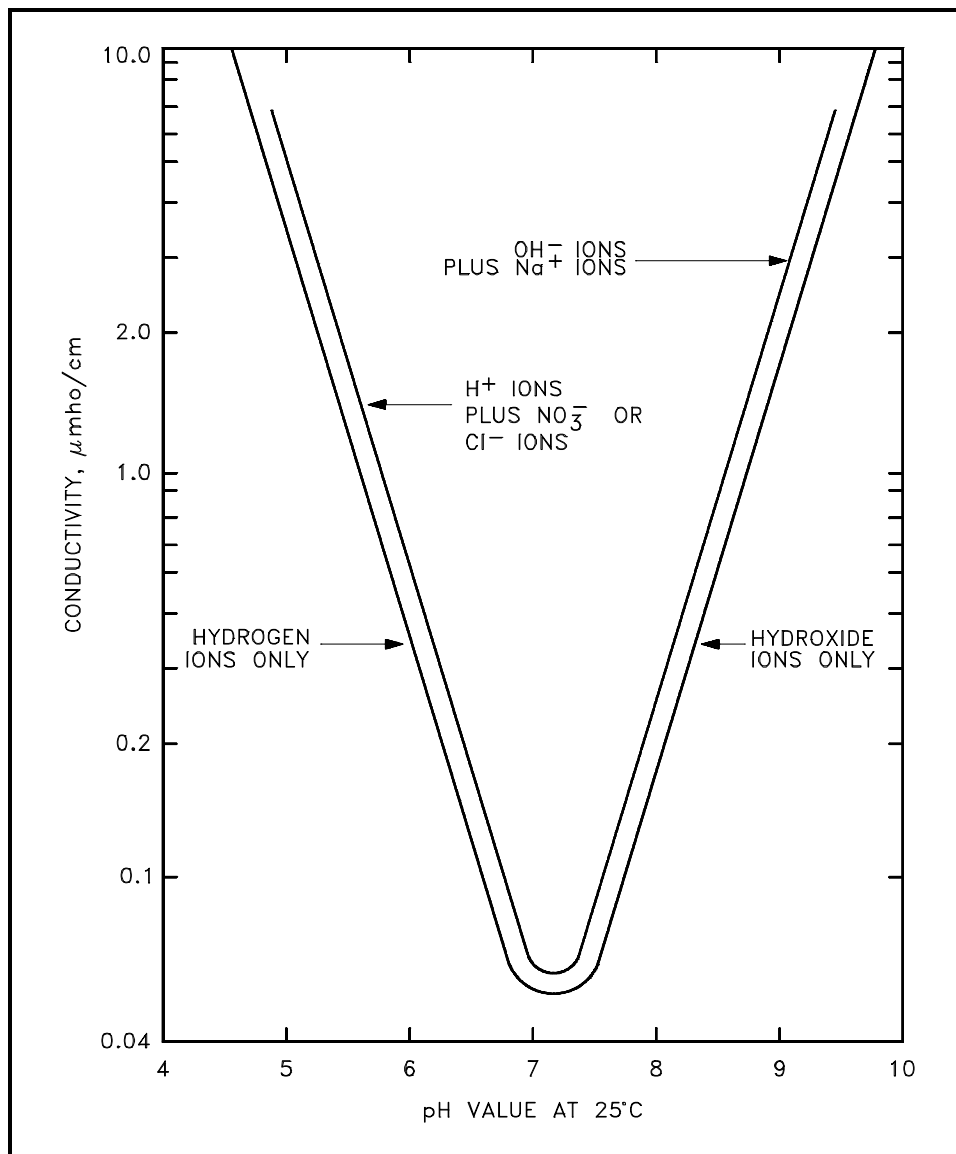

Figure 5 Theoretical Conductivity as a Function of pH

In both Figure 4 and Figure 5, a definite relationship exists between pH and conductivity, assuming no foreign ions are present. A similar graph could be constructed for those facilities using cation resins of a different base such as lithium or barium.

The key point of this discussion is the realization that a theoretical, or calculated, relationship does exist, and measurements that vary appreciably from the theoretical values should be investigated and corrective action taken.

Excessively high conductivity levels are an indication of the presence of undesired ions. This condition warrants further investigation to locate the source of the impurity because, in addition to other chemistry problems, it contributes to general corrosion by increasing the reaction rates of the electrochemical cells. The purity of the makeup water, and any pH control agents added, should be verified to determine the cause. pH should also be checked because of the relationship of these parameters. Other chemistry parameters should also be checked, such as Cl⁻ and F⁻. After the cause of high conductivity has been determined, appropriate steps should be taken to return conductivity to its normal value. One method that is often used is a feed and bleed procedure whereby water is added to and drained from the facility at the same time. If this method is used, verification of makeup water purity must be ensured to prevent compounding the problem.

Low conductivity is also an indicator of a potential problem because, in high purity basic systems, the only possible cause of low conductivity is a low pH. For example, in a system using high pH ammonium hydroxide control, the introduction of air into the facility could result in the formation of nitric acid (HNO₃) with a reduction in pH by the following reaction.



Conductivity decreases even more than would be expected because of the formation of NH₄NO₃. NO₃⁻ is not as conductive as OH⁻, so the NH₄NO₃ results in a lower conductivity than NH₄OH. This neutralization of NH₄OH is shown by the following reaction.

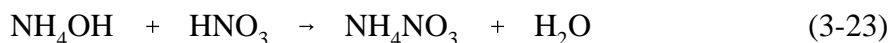

The water formed is only slightly ionized, so the solution conductivity is lowered even further.

Chlorides

Another parameter that is carefully monitored and controlled in most nuclear facilities is chloride (Cl⁻). The reason for maintaining the chloride ion concentration at the minimum level practicable is that several forms of corrosion are affected by the chloride ion, and the type of greatest concern is chloride stress corrosion. The mechanics of chloride stress corrosion were discussed in detail in Module 2 and will therefore not be repeated in this section.

When high levels of Cl^- are suspected, or detected, immediate steps must be taken to eliminate the source and remove Cl^- from the system because of the potential consequences. If Cl^- is present in the reactor coolant system, one method of removing it is to initiate a feed and bleed operation after determining that makeup water supplies are not the source of contamination. Because of the large volume of water normally contained in the reactor coolant system, cleanup by this method involves considerable amounts of pure water and a significant amount of time.

Additional problems associated with feed and bleed operations include changes in pH and a loss of H_2 from the reactor coolant system during the cleanup. Changes to either, or both, of these parameters have the potential to further aggravate the occurrence of chloride stress corrosion because: pH changes from the optimum operating limits cause increased general corrosion; and a loss of H_2 from the reactor coolant makes the dissolved oxygen that is normally present from either radiolysis or contained in the makeup water available to interact with the Cl^- ions. This would promote chloride stress corrosion (recalling that Cl^- , O_2 , and tensile stress are all necessary for chloride stress corrosion to occur).

The fact that a large amount of makeup water is being introduced will result in hydrogen depletion because even deaerated water contains small amounts of oxygen. H_2 will also be lost because of the draining of coolant from the system. During conditions that require the use of feed and bleed to correct a chemistry anomaly of any type, increased attention to all parameters becomes increasingly important.

Another method that may be used to control Cl^- concentrations in the reactor coolant is to route more bypass flow through the ion exchanger system, where installed. Use of this system precludes the requirements of a large inventory of makeup water as well as the disposal problems that arise from the bleed (draining) of coolant from the system. Because the ion exchanger has minimal effect on dissolved gases, depletion of hydrogen does not contribute to the potential of the problem. Increasing flow through the ion exchanger(s) may cause changes to the pH of the system, however, and as in the case of feed and bleed, increased vigilance is necessary to ensure pH, as well as other parameters, are properly controlled and maintained.

Fluorine

Fluorine (F^-) is another parameter monitored and controlled in some reactor facilities. High levels of F^- are potentially hazardous for two reasons. First, F^- promotes corrosion of zirconium by a stress corrosion mechanism at the inner surface of the clad (fluorine can be introduced to this region because of the existence of small defects or "pinholes" that cannot be completely avoided in the fuel clad). Second, F^- is a major contributor to radiation levels of the reactor coolant. Although some radioactive ^{18}F is produced by a proton, neutron reaction with ^{18}O , the only significant possible sources are impure makeup water or contamination of chemical agents, such as NH_3 and Li , which are added to the reactor coolant system.

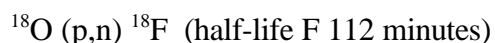

Removal of F⁻ is accomplished in the same manner as the removal of Cl⁻, that is, by feed and bleed or increased flow through the ion exchanger system. Removal by ion exchange, however, is not as effective as for Cl⁻ because of the lower affinity of F⁻ for exchange. As in the case of Cl⁻ contamination, if feed and bleed is the method selected for cleanup, the purity of the makeup water must be verified and other chemistry parameters monitored closely to preclude aggravation of the existing conditions.

Radioactivity

Radioactivity of the reactor coolant system is monitored and controlled because it is a good indicator of several conditions that may occur in the system. These include increased corrosion, crud bursts, fuel element defect or failure, and improper operation of the ion exchanger (where installed). Radioactivity levels in the reactor coolant system are normally kept at nominal values during normal conditions by the ion exchanger. In facilities that do not use ion exchangers, other methods that vary from facility to facility are used to control radioactivity. These include processes such as chemical cleanup followed by feed and bleed with subsequent disposal procedures and reactor shutdown in severe cases. Reactor coolant gaseous activity is also monitored, and it provides an indication of cladding failures and the introduction of air during reactor operation. Gaseous activity levels are normally controlled by degassification. Operating limits are established in most reactor facilities to operate the reactor safely, to limit radioactive releases to the environment, and to prevent excessive personnel exposure during operation and shutdown.

Tritium

This section provides introductory information about tritium and its properties.

Environmental Sources

Tritium occurs naturally in the environment. Reactions between cosmic rays and upper atmosphere constituents produce tritium. The following are examples of these reactions.

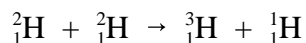
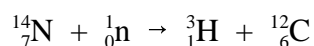

Tritium becomes incorporated into water and falls to earth as rain. At an estimated production rate of 4×10^6 Ci/Yr, a world steady state natural inventory of 70×10^6 Ci results.

Man-made Sources

Numerous potential and actual sources of tritium production exist in the United States, the United Kingdom, France, and other countries. They include light-water reactors, heavy-water reactors, fuel reprocessing facilities, and production reactors. Light-water reactors produce between 500 and 1000 Ci/yr of tritium in their coolant for every 1000 MW(e) of power. Heavy-water reactors produce approximately 2×10^6 Ci/yr of tritium in their coolant for every 1,000 MW(e) of power.

Atomic Weight/Hydrogen Isotopes

The atomic weights, symbols, and abundance of the three well-known isotopes of hydrogen are given in Table 2. ${}^4_1\text{H}$ and ${}^5_1\text{H}$ are also known. However, because they decay in fractions of a single second, they are not extensively studied. Unless otherwise specified in this chapter, the term hydrogen includes protium, deuterium, and tritium. ${}^1_1\text{H}$ will be used to refer to protium; confusion with elemental hydrogen will be eliminated by spelling out the latter.

Physical Symbol	Common Symbol	Name	Abundance (%)	Mass (amu)
${}^1_1\text{H}$	H	Protium	99.985	1.007825
${}^2_1\text{H}$	D	Deuterium	0.015	2.01400
${}^3_1\text{H}$	T	Tritium	β^- emitter*	3.01605

* 12.32-years half-life

Disintegration

Tritium decays by emitting a weak beta particle together with an antineutrino. The product is helium-3. Helium is a monatomic gas; therefore, the decay of 1 mole of T_2 yields 2 moles of helium. This causes a pressure buildup in sealed vessels containing diatomic tritium gas (or HT or DT gas). The following reaction is tritium disintegration.

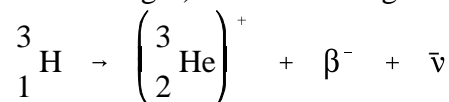

Solubility

Hydrogen gas (including tritium gas) dissolves to some extent in most materials. Tritium and deuterium behave like protium, except for small isotopic effects. Hydrogen atoms or diatomic hydrogen molecules and some larger hydrogen-bearing molecules dissolve interstitially; that is, they diffuse into a structure and locate between atoms or molecular frameworks. As it dissolves, the hydrogen slightly disrupts the structural networks of the material and causes expansion. The extent of the disruption, along with the extent of chemical attractive/repulsive forces between the hydrogen and the material, determines the ultimate equilibrium state.

Solubility in Polymers, Glasses, and Ceramics

Hydrogen gas dissolves as the molecular hydrogen species in many materials. For these systems, solubility is generally endothermic and is directly proportional to gaseous overpressure. The materials in which hydrogen dissolves as the molecular species include organic polymers and glasses at less than 150°C. Organic polymers generally have atomic-scale voids in the twisted polymer chain, and the hydrogen molecules seek these sites. Hydrogen dissolution in glasses is assumed to be similar.

Abnormal Chemistry Conditions

As indicated earlier in this module, there are times when actions taken regarding one specific chemistry parameter may affect more than that parameter (such as feed and bleed operations). This may also be the case during many abnormal conditions that the reactor coolant system may be subjected to.

In this section, we will consider the conditions resulting from injection of air, fuel element failure, and overheating of resin and discuss the probable changes to other chemistry parameters that may occur.

Injection of Air

Injection of small and large amounts of air into the reactor coolant system was previously analyzed. When sufficient oxygen is added to deplete the hydrogen inventory, acidic pH results in those facilities where high (basic) pH is maintained. This reduction in pH is accompanied by secondary effects to the coolant. The reduced pH causes a change in solubility of the corrosion film on facility materials and results in part of this film being released for transport throughout the coolant system. This release, or crud burst, is detected by an increase in radiation levels of the coolant, increased conductivity, and lowering of the ion exchanger efficiency. Radiation levels increase because corrosion products that had been attached to core surfaces and were highly activated by the neutron flux are transported to other parts of the system.

Conductivity increases because many of the corrosion products are released in an ionic or radical form and are capable of conducting electricity. In the early stages of the introduction of air, conductivity may exhibit erratic behavior because of the relationship of conductivity and pH. As pH begins to fall, conductivity tends to follow, but the presence of suspended corrosion products offsets the theoretical conductivity. The resultant increase is dependent upon the concentration of corrosion products. Additionally, should pH fall below about 7, conductivity increases as pH is further reduced.

Ion exchanger efficiency decreases because the increased crud inventory consists of both particulate and colloidal products. The ion exchanger is only about 90% effective as a filter, as compared to approximately 100% effectiveness as an ion exchanger, so effluent radioactivity levels increase by a greater proportion. Also, crud in the colloidal form has an even lower probability of being removed by ion exchange or filtration than does particulate crud, and again the effluent radioactivity is increased.

Hydrogen and total gas react as expected. Because air contains primarily N₂ and O₂, the gas inventory in the system increases. Hydrogen levels decrease because of reactions with both O₂ and N₂. Air also contains approximately 1% of ⁴⁰₁₈Ar by volume. When large amounts of air are added to the reactor coolant system, the ⁴⁰₁₈Ar becomes activated by the neutron flux in the core region and becomes radioactive in the form of ⁴¹₁₈Ar, causing an increase in the gaseous activity of the reactor coolant.

Figure 6 illustrates changes to chemistry in an experimental facility that was started up with high oxygen and nitrogen in the system from the deliberate addition of air. As the power level and temperature were increased, nitric acid formed and neutralized the ammonium hydroxide present from previous operation. Conductivity and pH decreased until pH 7 was reached; when the water became acidic the conductivity showed a corresponding increase. With the formation of nitric acid (from the nitrogen present), a corresponding increase in chromate ion was observed (in this case Cr concentrations are directly related to crud inventories and result from chemical attack on facility materials). The process was reversed by adding hydrogen, which combined with the oxygen and reduced the nitrate and chromate ions.

It should be noted, however, that in the above experiment the chromate ions were effectively removed from the coolant by decreasing their solubility. This would not be the case for the majority of the crud. The vast majority of crud would remain suspended in the coolant until it was either removed mechanically (filtered) or settled and redeposited at other locations in the system (including redeposition on the core surfaces).

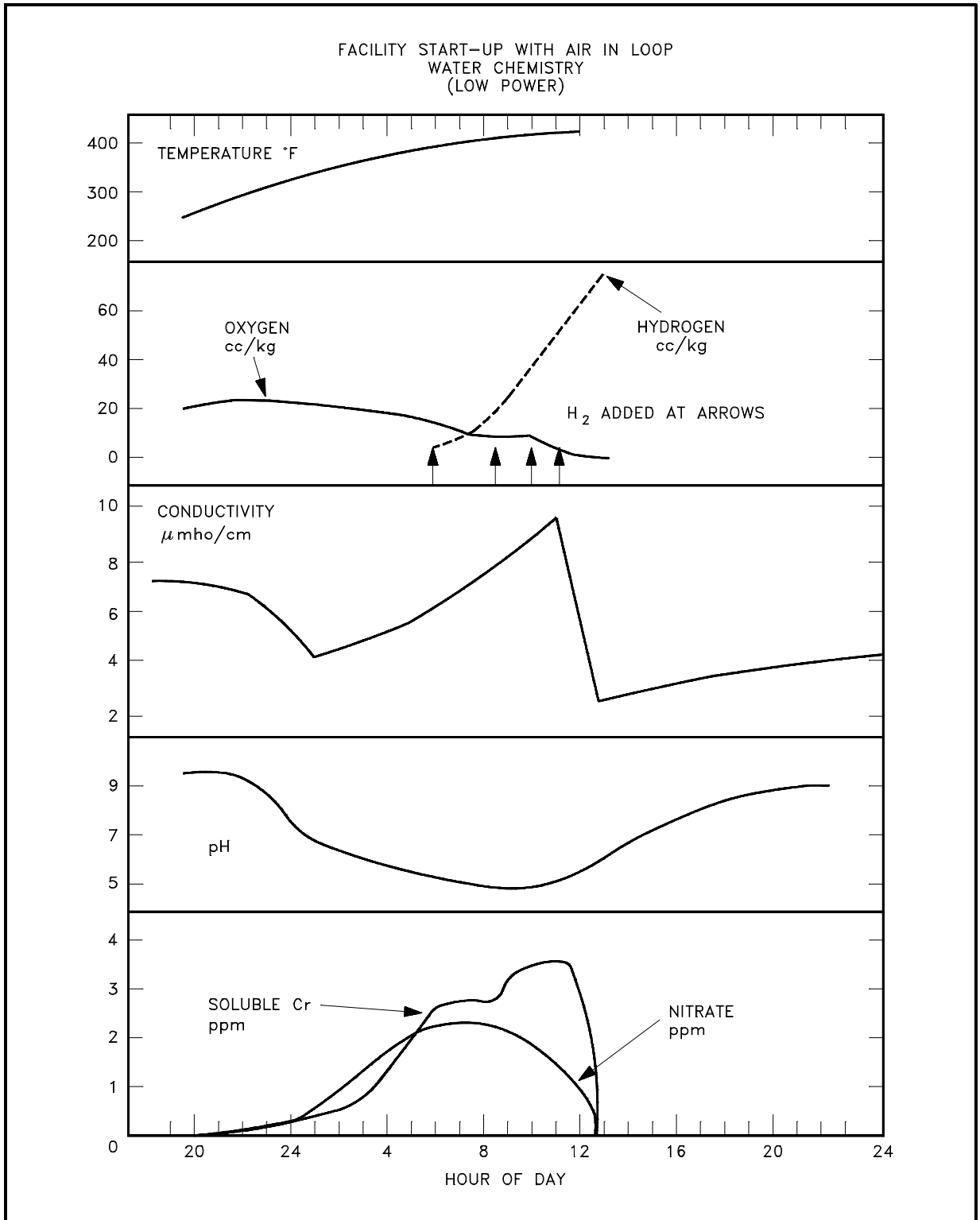

Figure 6 Facility Start-up With Air in Loop

Fuel Element Failure

During operation of a nuclear reactor facility an equilibrium level of fission products is established in the reactor coolant. These fission products are the result of trace impurities of fuel material contained in the cladding surfaces as either natural impurities or a result of the fuel fabrication process. The mechanism by which the fission products enter the coolant is normally by fission recoil. Weld porosity is another potential path for the fuel, but generally quality control prevents this from occurring. During normal facility operation, these fission products are minor contributors to the overall radioactivity of the reactor coolant system.

If a defect were present or a failure of a fuel element occurred, large amounts of fission products would potentially have a path to the coolant system. If this happened, significant changes would occur within the reactor coolant chemistry parameters. Because most facilities analyze for gross coolant radioactivity either continuously or periodically, the analysis would be likely to detect all but the most minute failures.

When routine gaseous radioactive levels are monitored, an increase in this parameter's value would be seen. This is because many of the fission products are gaseous, and these gases are more mobile than particles of exposed fuel (the exposed fuel generally undergoes a process of erosion that washes the fuel into the coolant stream). The other parameter that may change is the ion exchange efficiency (where utilized), because many of the fission products released have a lower affinity for the exchange sites on the resin beads than the exchange anion or cation. Accordingly, the ion exchanger would not effectively remove these fission products and effluent radioactivity levels would increase significantly. Fission gases would also pass on through the ion exchanger and contribute to effluent activity. In addition, because some of the fission gases have relatively short half-lives, the amount of time they are held up in the ion exchanger is sufficient for some of these gases to decay to a radioactive solid.

These solid particles would contribute to effluent samples that may be concentrated prior to analysis. Some facilities monitor for specific fission product inventories in the reactor coolant to provide base level information. If a defect or failure were to occur, these levels would obviously increase to indicate the failure.

Resin Overheating

Because the potential for elevated temperatures exists during most conditions of facility operation, we will summarize the results from the resin in an ion exchanger overheating. Module 4 addresses resin in great detail, and the actual resin breakdown will be included there. Basically the resin of an ion exchanger is an inert polystyrene structure with ion exchange sites "loosely" attached. The basic structure is stable up to fairly high temperatures (approximately 300°F), but the active exchange sites are not. There are two types of exchange sites: anion and cation. The anion resin begins to decompose slowly at about 140°F, and the decomposition

becomes rapid above 180°F. The cation resin is stable up to about 250°F. Because these temperatures are well below normal reactor coolant temperatures, the temperature of the coolant must be lowered before it passes through the ion exchange resin.

The decomposition of resin produces an alcohol form of the resin, which has no exchange capability, and trimethylamine (TMA), $N(CH_3)_3$. TMA is a weak base, similar to ammonia, that reacts with water as follows.

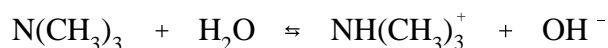

If large amounts of TMA are released to the coolant, the pH may increase noticeably. For example, 1 ppm of TMA in reactor coolant that uses lithium form resin will cause a noticeable increase in pH. TMA may also interfere with the analysis for chloride ions (which is routinely performed on reactor coolant) by giving a false indication of high chloride concentration. Another significant property of TMA is its intense odor of dead fish. Although the presence of such an odor from reactor coolant is not definitive for TMA, it may give an indication of resin overheating.

The other product of resin breakdown, $[R - CH_2N(CH_3)_2]$, is an amine with exchange capabilities considerably less than the original form of the resin. Thus, both reactions lead to partial (or complete) loss of exchange capability. If the temperature is sufficiently high, or if a lower temperature (but greater than 180°F) is sustained for a long enough period, the resin will be unfit for use. If the temperature becomes very high (greater than about 450°F), the polymeric base structure of the resin will decompose, forming a complex mixture of organic tars and oils.

The preceding discussion concerned the decomposition of resins in their original forms. It should be noted that if overheating occurs after the resin has been in operation for some time, part of the resin will be in a different form due to the exchange process. As a result, some of the previously removed impurities will be released to the coolant if decomposition occurs.

A number of changes are probable if overheating of resin occurs. Reactor coolant Cl^- levels would probably increase as a result of thermal breakdown and subsequent release. Ion exchanger effectiveness would be greatly reduced for similar reasons. Radioactivity levels of the reactor coolant would increase because of the release of impurities collected and later released from the resin. pH would likely decrease because of the release of H^+ ions from the resin complex and may cause acidic conditions in the reactor coolant if the temperature is sufficient (>250°F). Because certain types of resin decompose at lower temperatures, pH may increase as a result of the release of TMA and be accompanied by a dead fish odor. Because of the consequences of overheated resin, stringent temperature limitations are necessary. If overheating occurs, the ion exchanger should be taken out of service immediately and the cause rectified. The resin must be replaced prior to placing the ion exchanger back in service after overheating.

Summary

The important information in this chapter is summarized below.

Chemistry Parameters Summary

- Table 1 provides a summary of the parameters, why they are controlled, and the methods of control.
- The following abnormal chemistry conditions are discussed:

Injection of air will cause the hydrogen inventory to become depleted, which in turn can lead to a pH swing towards the acidic end. This reduced pH leads to a loosened corrosion film hence a crud burst. The crud burst causes higher radiation levels and an increase in conductivity.

Fuel element failure allows large amounts of fission products a possible release path to the reactor coolant. This could lead to a lowered ion exchange efficiency.

Resin overheating results in the decomposition of the resin. The products of the decomposition can seep into the reactor coolant and affect the chemistry in several ways. A few of the common products and their resulting influence on the chemistry is discussed.

**Department of Energy
Fundamentals Handbook**

**CHEMISTRY
Module 4
Principles of Water Treatment**

TABLE OF CONTENTS

LIST OF FIGURES	ii
LIST OF TABLES	iii
REFERENCES	iv
OBJECTIVES	v
PURPOSE OF WATER TREATMENT	1
Water Treatment	1
Summary	2
WATER TREATMENT PROCESSES	3
Principles of Ion Exchange	3
Specific Ion Exchanger Reactions	11
Summary	13
DISSOLVED GASES, SUSPENDED SOLIDS, AND pH CONTROL	15
Removal of Dissolved Gases	15
Removal of Suspended Solids	20
pH Control	21
Resin Bed Malfunctions	22
Summary	26
WATER PURITY	28
Water Purity	28
Summary	30

LIST OF FIGURES

Figure 1	Polymerization of Cross-Linked Polystyrene Resins	5
Figure 2	Production of Anion and Cation Forms of Cross-Linked Polystyrene Ion Exchange Resins	6
Figure 3	Schematic Diagram of a Typical Ion Exchanger	8
Figure 4	Typical History Curve	11
Figure 5	A Typical Pretreatment System	16
Figure 6	Behavior of Hydrogen Form Cation Exchange Bed as it Removes Ammonium Ions From Solution	23

LIST OF TABLES

Table 1 Typical Ionized Impurities in Water	2
Table 2 Properties of Ion Exchange Resins	9
Table 3 Water Purity	28

REFERENCES

- Donald H. Andrews and Richard J. Kokes, Fundamental Chemistry, John Wiley & Sons, Inc., 1963
- Compressed Gas Association, Inc., Handbook of Compressed Gases, 2nd Edition, Reinhold Publishing Corporation, 1981.
- R. A. Day, Jr. and R. C. Johnson, General Chemistry, Prentice Hall, Inc., 1974.
- Dickerson, Gray, Darensbourg and Darensbourg, Chemical Principles, 4th Edition, The Benjamin Cummings Publishing Company, 1984.
- Academic Program for Nuclear Plant Personnel, Volume II, Chemistry, Columbia, MD, General Physics Corporation, Library of Congress Card #A 326517, 1972.
- General Physics Corporation, Fundamentals of Chemistry, General Physics Corporation, 1982.
- Glasstone and Sesonske, Nuclear Reactor Engineering, 3rd Edition, Van Nostrand Reinhold Company, 1981.
- McElroy, Accident Prevention Manual for Industrial Operations Engineering and Technology, Volume 2, 8th Edition, National Safety Council, 1980.
- Sienko and Plane, Chemical Principles and Properties, 2nd Edition, McGraw and Hill, 1974.
- Underwood, Chemistry for Colleges and Schools, 2nd Edition, Edward Arnold, Ltd., 1967.
- Norman V. Steere and Associates, CRC Handbook of Laboratory Safety, 2nd Edition, CRC Press, Inc., 1971.

TERMINAL OBJECTIVE

- 1.0 Without references, **EXPLAIN** the concept and application of ion exchange in water purification.

ENABLING OBJECTIVES

- 1.1 **LIST** the three reasons for removing impurities from water prior to use in reactor systems.
- 1.2 **DEFINE** the following terms:
- | | |
|-----------------|----------------------------|
| a. Ion exchange | e. Polymer |
| b. Demineralize | f. Mixed-bed demineralizer |
| c. Cation | g. Affinity |
| d. Anion | h. Decontamination factor |
- 1.3 **DESCRIBE** the following:
- | |
|-----------------|
| a. Resin bead |
| b. Cation resin |
| c. Anion resin |
- 1.4 **DISCUSS** the following factors of ion exchange:
- | |
|---------------------------|
| a. Relative affinity |
| b. Decontamination factor |
- 1.5 **WRITE** the reaction for removal of NaCl and CaSO₄ by a mixed-bed ion exchanger such as one containing HOH resin.
- 1.6 **EXPLAIN** the three basic methods used to remove dissolved gases from water.
- 1.7 **LIST** five filtration mediums used to remove suspended solids from water.
- 1.8 **EXPLAIN** how mixed-bed ion exchangers may be used to control pH.

ENABLING OBJECTIVES (Cont.)

- 1.9 **DISCUSS** resin malfunctions, including the following:
- a. Channeling
 - b. Breakthrough
 - c. Exhaustion
- 1.10 **LIST** the maximum conductivity and approximate concentration of electrolyte for each level of purity for makeup water.

PURPOSE OF WATER TREATMENT

Water normally contains many impurities, among which are trace minerals and chemicals. The need for removing these impurities is discussed in this chapter.

EO 1.1 LIST the three reasons for removing impurities from water prior to use in reactor systems.

Water Treatment

Water treatment is necessary to remove the impurities that are contained in water as found in nature. Control or elimination of these impurities is necessary to combat corrosion, scale formation, and fouling of heat transfer surfaces throughout the reactor facility and support systems.

The following are three reasons for using very pure water in reactor facility systems.

1. To minimize corrosion, which is enhanced by impurities.
2. To minimize radiation levels in a reactor facility. Some of the natural impurities and most of the corrosion products become highly radioactive after exposure to the neutron flux in the core region. If not removed, these soluble and insoluble substances may be carried to all parts of the system.
3. To minimize fouling of heat transfer surfaces. Corrosion products and other impurities may deposit on core surfaces and other heat transfer regions, which result in decreased heat transfer capabilities by fouling surfaces or blockage of critical flow channels. Areas of high concentrations of these impurities and corrosion products may also lead to extreme conditions of the various corrosion processes with resultant failure of components or systems.

There are several processes used in reactor facilities to purify the water in the systems and water used as makeup. Deaeration is used to strip dissolved gases, filtration is effective in the removal of insoluble solid impurities, and ion exchange removes undesirable ions and replaces them with acceptable ions. Typical ionized impurities found in water are shown in Table 1.

TABLE 1	
Typical Ionized Impurities in Water	
Cations	Anions
Ca^{++}	NO_3^-
Mg^{++}	OH^-
Na^+	SO_4^{--}
K^+	Cl^-
Al^{+++}	HCO_3^-
Fe^{++}	HSiO_3^-
Cu^{++}	HCrO_3^-

Summary

The important information in this chapter is summarized below.

Purpose of Water Treatment Summary

- There are three general reasons to treat water for its impurities:
 1. To minimize corrosion, which is enhanced by impurities
 2. To minimize radiation levels in the reactor facility
 3. To minimize fouling of heat transfer surfaces

WATER TREATMENT PROCESSES

One of the more common water treatment methods is the use of demineralizers and ion exchange. This method will be discussed in this chapter.

EO 1.2 DEFINE the following terms:

- | | |
|--|---|
| <p>a. Ion exchange</p> <p>b. Demineralize</p> <p>c. Cation</p> <p>d. Anion</p> | <p>e. Polymer</p> <p>f. Mixed-bed demineralizer</p> <p>g. Affinity</p> <p>h. Decontamination factor</p> |
|--|---|

EO 1.3 DESCRIBE the following:

- a. Resin bead**
- b. Cation resin**
- c. Anion resin**

EO 1.4 DISCUSS the following factors of ion exchange:

- a. Relative affinity**
- b. Decontamination factor**

EO 1.5 WRITE the reaction for removal of NaCl and CaSO₄ by a mixed-bed ion exchanger such as one containing HOH resin.

Principles of Ion Exchange

Ion exchange is a process used extensively in nuclear facilities to control the purity and pH of water by removing undesirable ions and replacing them with acceptable ones. Specifically, it is the exchange of ions between a solid substance (called a resin) and an aqueous solution (reactor coolant or makeup water). Depending on the identity of the ions that a resin releases to the water, the process may result in purification of water or in control of the concentration of a particular ion in a solution. An *ion exchange* is the reversible exchange of ions between a liquid and a solid. This process is generally used to remove undesirable ions from a liquid and substitute acceptable ions from the solid (resin).

The devices in which ion exchange occurs are commonly called demineralizers. This name is derived from the term *demineralize*, which means the process whereby impurities present in the incoming fluid (water) are removed by exchanging impure ions with H⁺ and OH⁻ ions, resulting in the formation of pure water. H⁺ and OH⁻ are present on the sites of resin beads contained in the demineralizer tank or column.

There are two general types of ion exchange resins: those that exchange positive ions, called cation resins, and those that exchange negative ions, called anion resins. A *cation* is an ion with a positive charge. Common cations include Ca^{++} , Mg^{++} , Fe^{++} , and H^+ . A *cation resin* is one that exchanges positive ions. An *anion* is an ion with a negative charge. Common anions include Cl^- , SO_4^- , and OH^- . An *anion resin* is one that exchanges negative ions. Chemically, both types are similar and belong to a group of compounds called *polymers*, which are extremely large molecules that are formed by the combination of many molecules of one or two compounds in a repeating structure that produces long chains.

A *mixed-bed demineralizer* is a vessel, usually with a volume of several cubic feet, that contains the resin. Physically, ion exchange resins are formed in the shape of very small beads, called *resin beads*, with an average diameter of about 0.005 millimeters. Wet resin has the appearance of damp, transparent, amber sand and is insoluble in water, acids, and bases. Retention elements or other suitable devices in the top and bottom have openings smaller than the diameter of the resin beads. The resin itself is a uniform mixture of cation and anion resins in a specific volume ratio depending on their specific gravities. The ratio is normally 2 parts cation resin to 3 parts anion resin.

In some cases, there may be chemical bonds formed between individual chain molecules at various points along the chain. Such polymers are said to be cross-linked. This type of polymer constitutes the basic structure of ion exchange resins. In particular, cross-linked polystyrene is the polymer commonly used in ion exchange resins. However, chemical treatment of polystyrene is required to give it ion exchange capability, and this treatment varies depending on whether the final product is to be an anion resin or a cation resin.

The chemical processes involved in producing anion and cation resins are outlined in Figure 1 and Figure 2, beginning with the formation of cross-linked polystyrene. The polymer itself is a covalent compound. By the chemical reactions indicated in Figure 2, hydrogen atoms covalently bonded to the original polymer at certain sites are replaced by functional groups (called radicals) such as SO_3H (sulfonic acid) and $\text{CH}_2\text{N}(\text{CH}_3)_3\text{Cl}$ (quaternary ammonium). Each such group is covalently bonded to the polymer, but each also contains an atom that is bonded to the radical group by a predominantly ionic bond. In the two examples above, H in SO_3H and Cl in $\text{CH}_2\text{N}(\text{CH}_3)_3\text{Cl}$ are the ionically-bonded atoms. Sometimes these are written as $\text{SO}_3^- \text{H}^+$ and $\text{CH}_2\text{N}(\text{CH}_3)_3^+ \text{Cl}^-$ to emphasize their ionic characters. These ions (H^+ and Cl^-) are replaceable by other ions. That is, H^+ will exchange with other cations in a solution, and Cl^- will exchange with other anions.

In its final form, an ion exchange resin contains a huge, but finite, number of sites occupied by an exchangeable ion. All of the resin, except the exchangeable ion, is inert in the exchange process. Thus, it is customary to use a notation such as R-Cl or H-R for ion exchange resins. R indicates the inert polymeric base structure and the part of the substituted radical that does not participate in exchange reactions. The term R is inexact because it is used to represent the inert portion of both cation and anion resins, which are slightly different. Also, the structure represented by R contains many sites of exchange, although only one is shown by the notation, such as R-Cl. Despite these drawbacks, the term R is used for simplicity.

Figure 1 Polymerization of Cross-Linked Polystyrene Resins

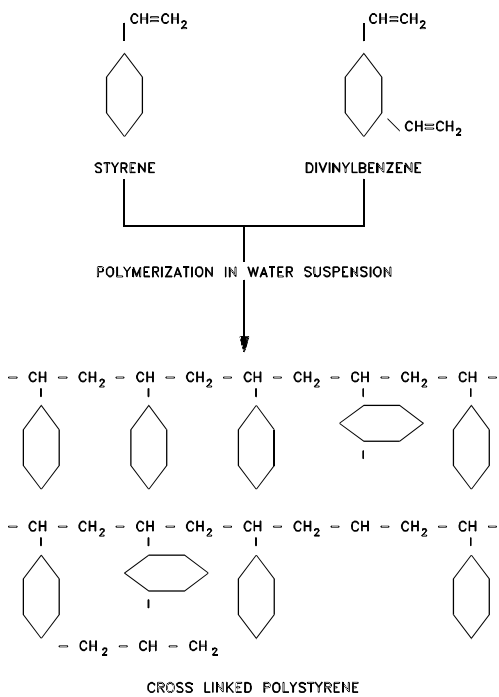

NOTE:
DASHES ARE USED TO REPRESENT BONDS BETWEEN A CARBON AND OTHER ATOMS THUS CH₃ - CH₃ REPRESENTS A

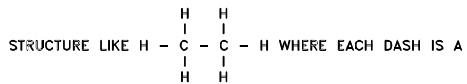

CHEMICAL BOND DOUBLE DASHES REPRESENT WHAT IS CALLED A DOUBLE BOND BETWEEN CARBON ATOMS

THE SYMBOL IS A SHORTHAND REPRESENTATION OF A BENZENE RING ITS ACTUAL STRUCTURE IS A RING OF 6 CARBON ATOMS WITH THE FOLLOWING BONDS AND ATTACHED HYDROGEN ATOMS

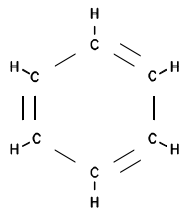

BENZENE RING

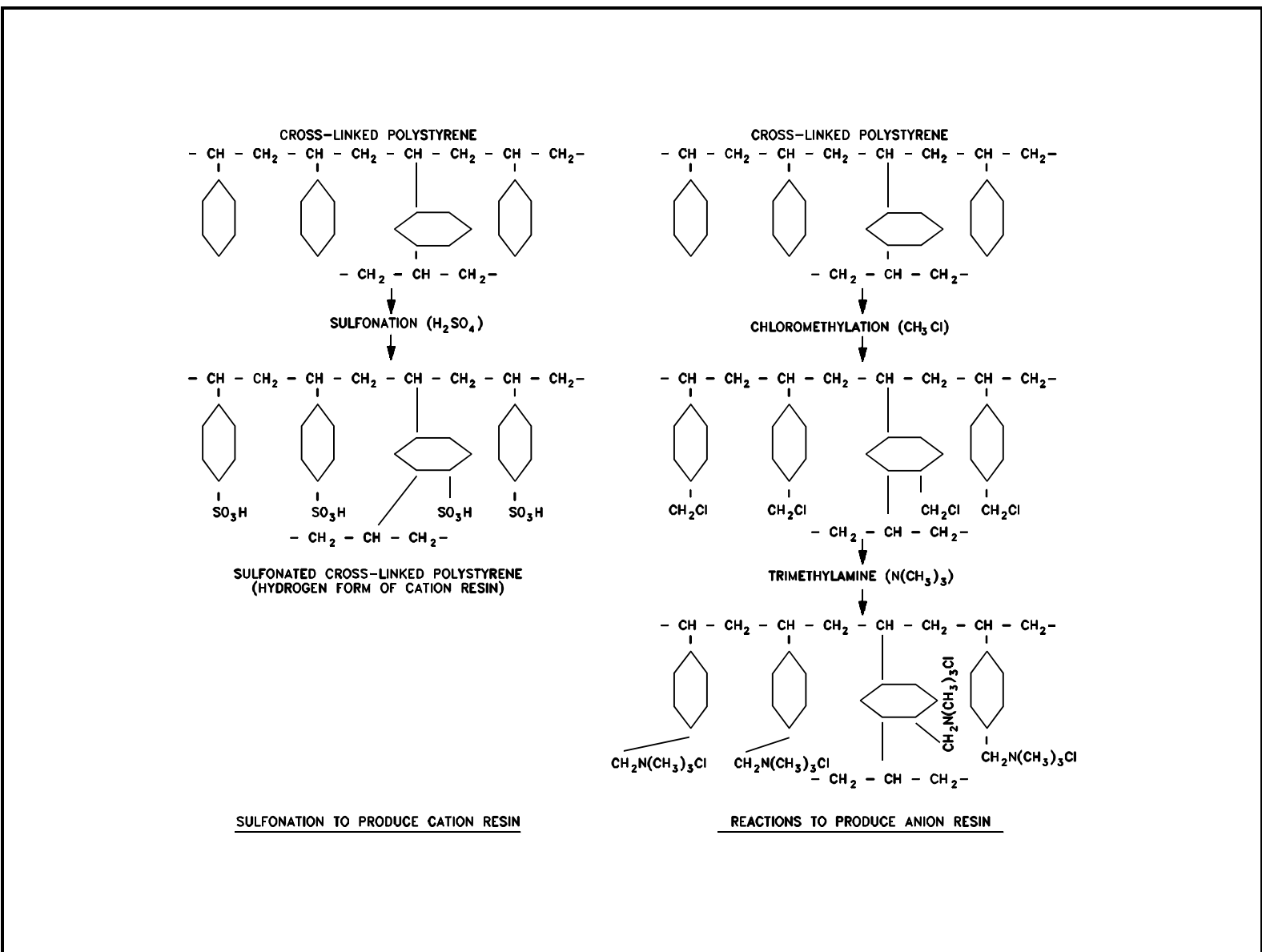
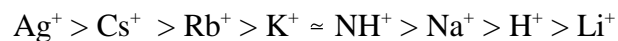
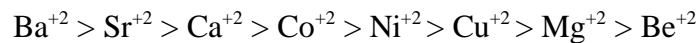

Figure 2 Production of Anion and Cation Forms of Cross-Linked Polystyrene Ion Exchange Resins

A particular resin may be prepared in different forms according to the identity of the exchangeable ion attached. It is usually named according to the ion present on the active sites. For example, the resin represented by R-Cl is said to be the chloride form of the anion resin, or simply the chloride form resin. Other common forms are the ammonium form (NH₄-R), hydroxyl form (R-OH), lithium form (Li-R), and hydrogen form (H-R).

The mechanics of the ion exchange process are somewhat complicated, but the essential features can be understood on the basis of equilibrium concepts discussed in Module 1 and recognition that the strength of the ionic bond between the resin and an ion varies with the particular ion. That is, for a particular resin, different ions experience different attractions to the resin. The term *affinity* is often used to describe the attraction between a resin and a given ion. This affinity can be described quantitatively by experimental determination of a parameter called the relative affinity coefficient. For a qualitative discussion, it suffices to note the *relative affinities* between a resin and different ions.

In order of decreasing strength, the relative affinities between a cation resin and various cations are as follows.



Similarly, the relative affinities between an anion resin and various anions are as follows.



The physical arrangement of one type of ion exchange vessel for purifying water is shown in Figure 3. The ion exchange resin is contained in a vessel with a volume of several cubic feet. Retention elements at the top and bottom consist of screens, slotted cylinders, or other suitable devices with openings smaller than the resin beads to prevent the resin from escaping from the vessel. The resin bed is a uniform mixture of cation and anion resins in a volume ratio of 2 parts cation resin to 3 parts anion resin. This arrangement is called a mixed-bed resin, as opposed to an arrangement of cation and anion resins in discrete layers or separate vessels. The use of different volumes of the two types of resins is due to the difference in exchange capacity between cation and anion resins. *Exchange capacity* is the amount of impurity that a given amount of resin is capable of removing, and it has units of moles/ml, equivalents/ml, or moles/gm. The anion resin is less dense than the cation resin; thus, it has a smaller exchange capacity, and a larger volume is needed for anion resins than for the cation resins to obtain equal total exchange capabilities.

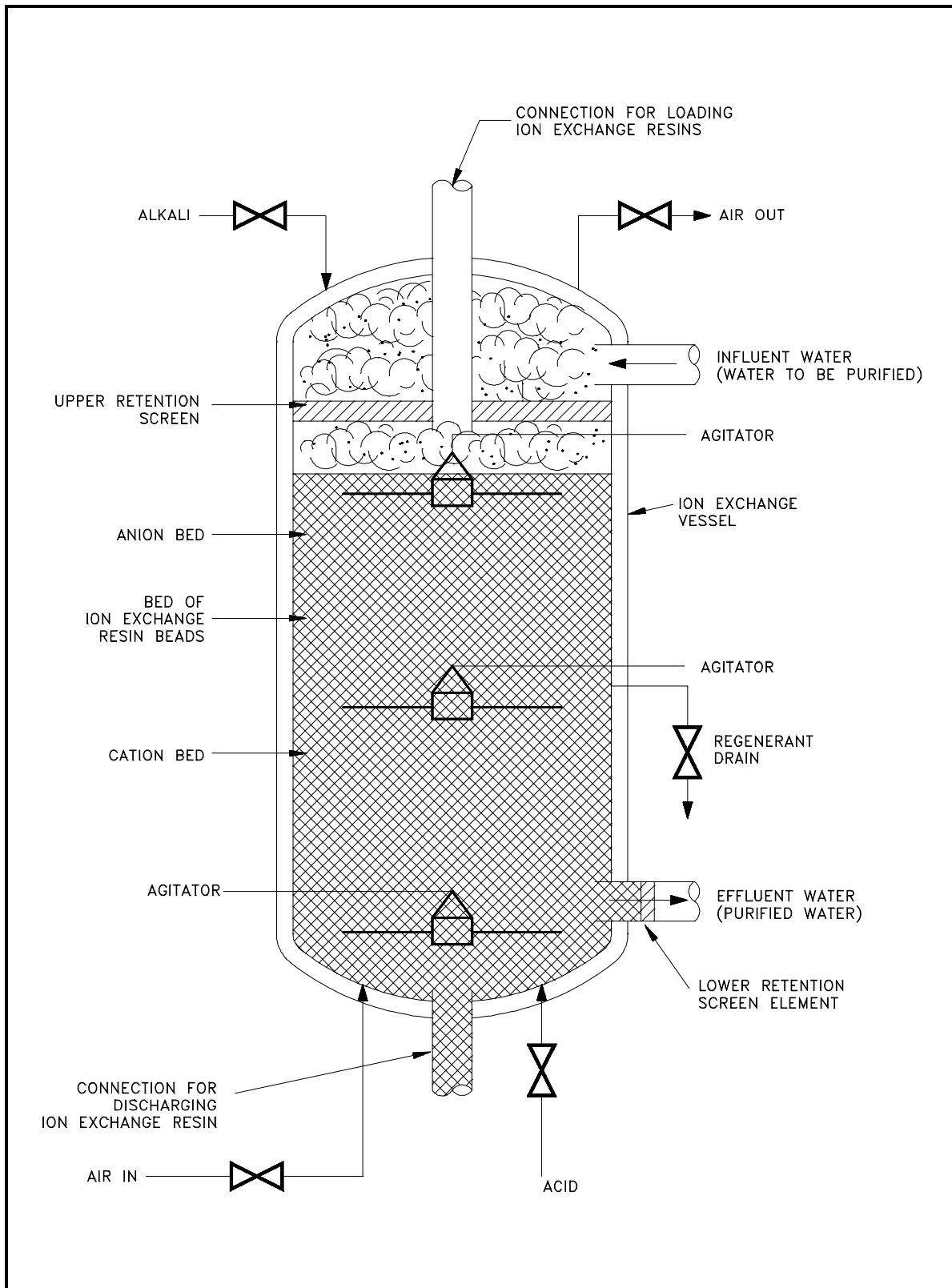

Figure 3 Schematic Diagram of a Typical Ion Exchanger

Because of the different densities of anion and cation resins, the flow of solution (impure water) is from top to bottom. If the flow were reversed, the lighter anion resin would gradually rise to the top by a process called classification, resulting in a layer of anion resin on top of the cation resin, as shown in Figure 3. In the example shown, the layering results from regeneration and/or backwash. In systems not using a backwash, the anion and cation resin beads are uniformly mixed. Many systems use a backwash procedure, if the resins are regenerated, to remove solids collected by filtration and to separate the resins for regeneration. They are remixed after regeneration.

For fixed amounts of anion and cation resins, the efficiency for removal of impurities is greater in a mixed-bed resin than a layered arrangement. The main reason is that for layered resins there may be large pH gradients within the column of resin. If, for example, the hydroxyl form resin is on top, as solution passes through it anionic impurities are removed and replaced by OH^- ions; thus, the pH increases. This increase in pH may decrease the efficiency in lower portions of the resin bed for removing impurities. It may also cause some impurities to precipitate because solubility changes with pH. The resin column will filter some undissolved material, but the efficiency for filtration is usually significantly less than that for removal by ion exchange. Thus, the overall efficiency is less than in a mixed-bed resin.

The capacity of ion exchange resins to remove impurity ions is given in Table 2 along with other information on resins. For instance, each cubic foot of a mixed-bed resin is capable of exchanging with 19.8 moles each of monovalent cations and anions. Mixed-bed resins are available commercially and in practical applications several cubic feet are used in a purification system.

Properties	Cation Resin	Anion Resin	Mixed-Bed Resin
Ion exchange capacity, moles of single ion/ml	1.75×10^{-3}	1.20×10^{-3}	0.7×10^{-3} anion & cation
Ion exchange capacity, moles of single ion/ft ³	49.5	34.0	19.8 anion & cation
Density of wet resin particles, grams/ml	1.27	1.10	--
Bulk density of loaded bed (including voids), grams/ml	0.80	0.62	0.70
Volume fraction	--	--	60% anion & 40% cation

The ion exchange process is reversible. If too much solution is passed through the ion exchanger (that is, the capacity of the resin has been exceeded) the exchange may reverse, and undesirable ions or other substances that were previously removed, will be returned to the solution at the effluent. Therefore, it is necessary to periodically monitor the performance of the ion exchanger and either replace or regenerate the resin when indicated. Ion exchanger performance is measured by comparing the solution concentration, conductivity, or radioactivity at the influent and effluent. The parameter measured depends upon the purpose of the ion exchanger. The term normally applied to ion exchanger effectiveness is *decontamination factor* (DF), which is defined as a ratio of the concentration (or activity) of the fluid at the inlet compared to the concentration (or activity) at the effluent, which expresses the effectiveness of an ion exchange process.

$$DF = \frac{\text{Influent concentration, conductivity, or radioactivity}}{\text{Effluent concentration, conductivity, or radioactivity}}$$

Example 1:

An ion exchanger influent contains 15 ppm chloride (Cl). Effluent chloride is measured at 0.1 ppm. What is the DF of this ion exchanger?

Solution:

$$DF = \frac{\text{Influent concentration}}{\text{Effluent concentration}}$$

$$DF = \frac{15 \text{ ppm Cl}}{0.1 \text{ ppm Cl}}$$

$$DF = 150$$

Example 2:

Reactor coolant activity entering the purification ion exchanger equals 2.8×10^{-2} $\mu\text{Ci/ml}$ gross activity. Ion exchanger effluent activity taken at the same time and conditions is measured at 1.0×10^{-4} $\mu\text{Ci/ml}$. What is the DF?

Solution:

$$DF = \frac{\text{Influent radioactivity}}{\text{Effluent radioactivity}}$$

$$DF = \frac{2.8 \times 10^{-2} \mu\text{Ci/ml}}{1.0 \times 10^{-4} \mu\text{Ci/ml}}$$

$$DF = 280$$

Resin performance may be monitored using a history curve that plots DF with respect to time. A typical history curve is shown in Figure 4, with the resin considered "exhausted" at point X.

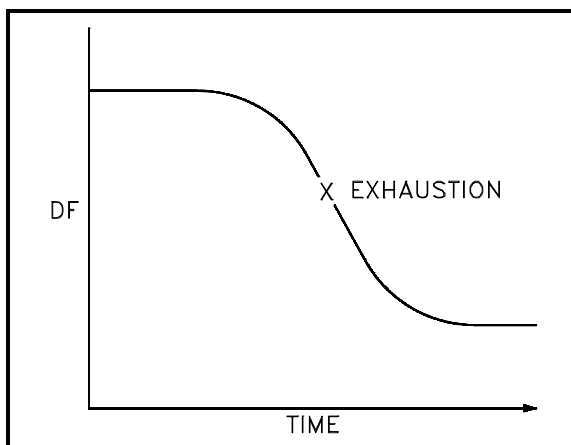
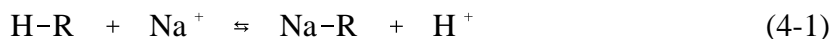

Figure 4 Typical History Curve

Specific Ion Exchanger Reactions

Suppose a solution containing Na^+ ions is passed through hydrogen resin. From the relative affinities given earlier, Na^+ ions are attracted to the resin more strongly than H^+ ions. Thus, Na^+ ions will displace H^+ ions from the resin or, in other words, Na^+ ions and H^+ ions exchange place between resin and solution. The process can be described by the following equilibrium reaction.



In most practical situations, a solution containing impurities at low concentrations is passed through a large amount of resin. By LeChatelier's Principle, the equilibrium of Reaction (4-1) is forced far to the right. The equilibrium is displaced so far that, for practical purposes, all Na^+ ions are removed from solution and replaced by H^+ ions. As a result, the solution will be acidic because of the excess of H^+ ions.

If a solution containing Cl^- ions is passed through hydroxyl resin, the Cl^- ions will be removed according to the following reaction.

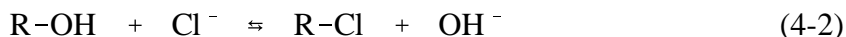

Again, for a dilute solution and a large amount of resin, the removal of Cl^- ions is essentially 100 percent complete. In this case, the final solution will be basic because of the excess of OH^- ions.

Consider a situation in which the entering impurities are calcium sulfate (CaSO_4) and sodium chloride (NaCl), and the ion exchanger is a mixture of both hydrogen and hydroxyl resins (mixed-bed).



In the reaction with NaCl , both Na^+ and Cl^- ions are removed from solution and replaced by H^+ and OH^- ions, respectively (the CaSO_4 reaction has the same result). If the initial solution contained only NaCl , then the concentrations of Na^+ and Cl^- ions were equal. Because both are removed with 100 percent efficiency, the concentrations of H^+ and OH^- ions added to the solution are equal; thus, the solution is neutral. In solution, H^+ and OH^- ions must obey the relationship for the ionization of water (refer to Module 1).

$$K_w = 10^{-14} = [\text{H}^+] [\text{OH}^-]$$

Because of the very small value of the dissociation constant K_w , the great majority of H^+ and OH^- ions supplied by the resin must combine to form water by the following reaction.



By this process, the original NaCl solution becomes pure water.

The preceding examples involve hydrogen and hydroxyl resins. The use of other resins, especially cation resins, is very common. For instance, suppose a solution containing Na^+ ions is passed through a lithium resin. Again referring to the relative affinities, Na^+ is attracted to the resin more strongly than is Li^+ ; thus, Na^+ ions will displace Li^+ from the resin.

Summary

The important information in this chapter is summarized below.

Ion Exchange Summary

- Demineralize is defined as the process whereby impurities present in the incoming fluid (water) are removed by exchanging impure ions with H^+ and OH^- ions resulting in the formation of pure water.
- Ion exchange is a process used extensively in nuclear facilities to control the purity and pH of water by removing undesirable ions and replacing them with acceptable ones.
- Mixed-bed demineralizer is a vessel containing resin that is a uniform mixture of cation and anion resins in a specific volume ratio depending on their specific gravities. Normally the ratio is 2 parts cation resin to 3 parts anion resin.
- Cation is an ion with a positive charge. Common cations include Ca^{++} , Mg^{++} , Fe^{++} , and H^+ . A cation resin is one that exchanges positive ions.
- Anion is an ion with a negative charge. Common anions include Cl^- , SO_4^{-2} , and OH^- . An anion resin is one that exchanges negative ions.
- Decontamination factor (DF) is a ratio of the concentration (or activity) of the fluid at the inlet compared to the concentration (or activity) at the effluent, which defines the effectiveness of the ion exchange process. Mathematically it is:

$$DF = \frac{\text{Influent concentration, conductivity, or radioactivity}}{\text{Effluent concentration, conductivity, or radioactivity}}$$

- Polymers are extremely large molecules that are formed by the combination of many molecules of one or two compounds in a repeating structure that produces long chains.
- Affinity is often used to describe the attraction between a resin and a given ion. This affinity can be described quantitatively by experimental determination of a parameter called the relative affinity coefficient.

Ion Exchange Summary (Cont.)

- Resin beads are long-chain cross-linked polymers that contain sites occupied by exchangeable ions. The general order of affinity serves as a useful guide in understanding many ion exchange processes. Cation and anion resins are named according to the identity of the ion occupying the exchange sites, such as hydrogen, hydroxyl, and chloride. Mixed-bed resins are used to remove both cations and anions.
- The effectiveness of any ion exchanger is directly related to the relative affinities between a resin and different ions. In order of decreasing strength, the relative affinities between a cation resin and various cations are:

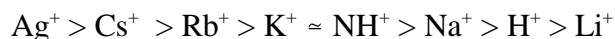
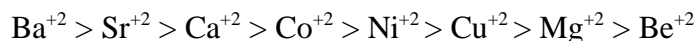

Similarly, the relative affinities of the anion resin for various anions are:



The higher the relative affinity the more effective the ion exchanger. This effectiveness is expressed by the Decontamination Factor.

- The reaction for removal of NaCl and CaSO₄ by a mixed-bed ion exchanger such as one containing HOH resin is as follows:

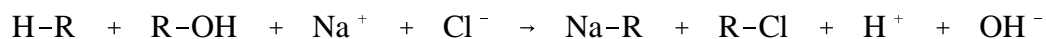
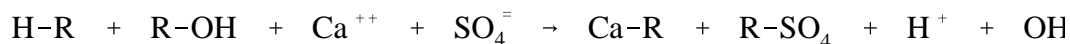

DISSOLVED GASES, SUSPENDED SOLIDS, AND pH CONTROL

The presence of dissolved gases, suspended solids, and incorrect pH can be detrimental to the water systems associated with a reactor facility. Therefore, these conditions must be minimized or eliminated to reduce corrosion in the systems of the facility. The way these conditions are controlled and the difficulties in controlling them are discussed in this chapter.

- EO 1.6** **EXPLAIN the three basic methods used to remove dissolved gases from water.**
- EO 1.7** **LIST five filtration mediums used to remove suspended solids from water.**
- EO 1.8** **EXPLAIN how mixed-bed ion exchangers may be used to control pH.**
- EO 1.9** **DISCUSS resin malfunctions, including the following:**
- a.** **Channeling**
 - b.** **Breakthrough**
 - c.** **Exhaustion**
-

Removal of Dissolved Gases

Dissolved gases result from different sources depending upon which system we examine. In the following discussion, we will address makeup water, reactor coolant systems, secondary facility water systems, the sources of dissolved gases, and methods used to reduce their concentrations to acceptable levels.

Many facilities use raw water as a source for makeup water systems. Pretreatment of this water is accomplished in various ways from distillation to a series of distinct processes as shown in Figure 5. In a pretreatment system similar to that shown in Figure 5, a resin column containing a cation resin (hydrogen form) is used to remove cations. The water entering the cation exchanger contains numerous ions including sodium (Na^+), bicarbonate (HCO_3^-), and others (HCO_3^- is one of the major impurities in many raw water systems). Na^+ ions result from the water softener located upstream in the pretreatment system. In addition to the HCO_3^- ions, raw water contains large amounts of magnesium (Mg^{++}) and calcium (Ca^{++}), as well as small amounts of other ionic impurities.

The cation exchanger contains resin in the hydrogen form. In this treatment step, essentially all cations entering the ion exchanger will be held at the exchange site, and H^+ will be released as shown in the following typical reaction (the anions, specifically the HCO_3^- ions, are unaffected by the cation exchanger).

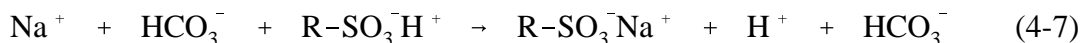

The water leaving the resin is somewhat acidic (depending on the incoming ion concentration) because it contains H^+ ions and whatever anion was associated with the incoming cation. After passing through the cation resin, the HCO_3^- ions combine with the H^+ ions to form carbonic acid (H_2CO_3). Carbonic acid is a weak acid that will decompose to water and CO_2 by the following reaction.



Because the carbonic acid readily dissociates, the aerator is used to remove the CO_2 from the makeup water at this point in the system. If we aerate the water by some means, such as spraying it through a tower or blowing air through the water, the CO_2 is "stripped" from the water and vented to the atmosphere. The removal of CO_2 forces Reaction (4-8) to shift to the right, which converts more H_2CO_3 to CO_2 . With sufficient aeration, all bicarbonate (HCO_3^-), and therefore CO_2 , can be removed.

Similar reactions occur in the anion exchanger. For example, anion resin, which has hydroxide ions at the exchange sites, will react as indicated in the following typical reaction.

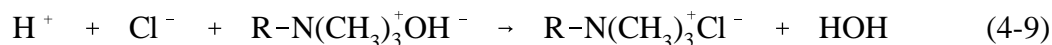

In this pretreatment system, the anion resin is downstream of the cation resin, and the only cations present are hydrogen ions. When the hydroxyl ions are released from the anion exchange sites, they combine with the hydrogen ions to form water. As a result, pure water appears at the effluent (this is somewhat overstated because a very small amount of other cations and anions pass unaffected through the resin columns in actual practice).

Another method sometimes used to remove dissolved gases from water is deaeration. In this process, the water is stored in vented tanks containing electric heaters or steam coils. The water is heated to a temperature sufficient for slow boiling to occur. This boiling strips dissolved gases from the stored water, and these gases are then vented to the atmosphere. Usually, the vented gases are directed through a small condenser to limit the loss of water vapor that would escape as steam along with the gases. This method is particularly effective in removing dissolved oxygen as well as other entrained gases (CO_2 , N_2 , and Ar).

Removal of dissolved gases from the reactor coolant system is usually accomplished by venting a steam space or high point in the system. In pressurized water reactors (PWR), this is normally accomplished in the pressurizer. The steam space is the high point of the system, and the boiling and condensing action causes a constant stripping of dissolved gases to occur. The steam space is vented either intermittently or constantly, and the gases are carried off in the process.

In addition to the mechanical means mentioned above, the use of scavengers in a PWR prevents the presence of dissolved oxygen. Two methods are normally used in this regard. When facility temperature is above approximately 200°F, gaseous hydrogen is added and maintained in the primary coolant to scavenge oxygen by the following reaction.



The other scavenger is hydrazine (N_2H_4). Hydrazine is thermally unstable and decomposes at temperatures above 200°F to form ammonia (NH_3), nitrogen (N_2), and hydrogen (H_2). Consequently, the use of hydrazine as an oxygen scavenger is limited to temperatures below 200°F. Hydrazine scavenges oxygen by the following reaction.



The presence of dissolved gases in the steam facility of a PWR is as detrimental as the presence of these gases is in the reactor coolant systems. Because steam facility systems contain metals other than stainless steel, they are even more susceptible to certain types of corrosion in the presence of oxygen and carbon dioxide. Removal of dissolved gases from the steam system is accomplished in two ways: by mechanical means such as air ejectors or mechanical pumps; and by using chemicals that scavenge oxygen.

Because boiling occurs in the steam generators, any dissolved gases entrained in the feedwater will be stripped out during the boiling process. These gases are carried with the steam through the turbines and auxiliary systems and ultimately end up in the condensers. The design of the condensers is such that noncondensable gases (for example, O_2 , CO_2) are collected and routed to the air removal system (which consists of air ejectors or mechanical pumps), where they are subsequently discharged to the atmosphere.

Scavenging involves the use of solid additives and volatile chemicals. One commonly-used solid chemical additive is sodium sulfite (Na_2SO_3). Scavenging of oxygen occurs by the following reaction.



As can be seen by Reaction (4-12), oxygen is consumed in the reaction resulting in the formation of sodium sulfate, Na_2SO_4 (a soft sludge). Addition of this scavenging agent is limited to drum-type steam generators. Once Thru Steam Generators (OTSG) do not use this method, but instead use controls that keep all scale-forming chemicals out of the steam generators.

Sodium sulfite reacts rapidly with oxygen and is a very efficient scavenger. However, being a solid and the source of another solid (Na_2SO_4) that is produced during the reaction, sodium sulfite has the potential of fouling heat transfer surfaces. An additional problem associated with the use of sodium sulfite is corrosion of secondary system components resulting from its decomposition products. At the temperatures present in the steam generators, sodium sulfite can decompose as follows.

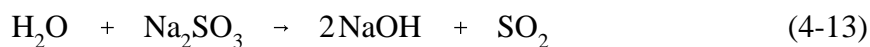

Sulfur dioxide (SO_2) is a gas and is carried over to the remainder of the steam facility. With water (in the steam or in the feed/condensate system), the SO_2 reacts in the following manner.

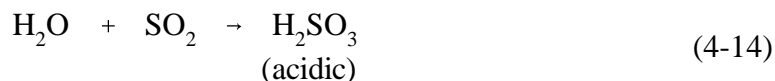

This acidic condition is corrosive to all components in the secondary system.

Because of the problems associated with sodium sulfites, many facilities use volatile chemistry control of the secondary steam system to control dissolved gases in conjunction with air removal systems. This control utilizes hydrazine (Reaction 4-11) and morpholine (Reaction 4-15) to eliminate oxygen and carbon dioxide, respectively.

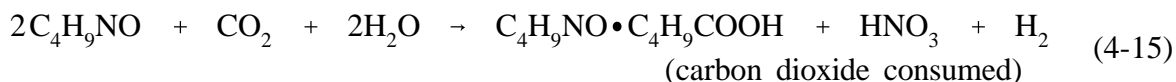
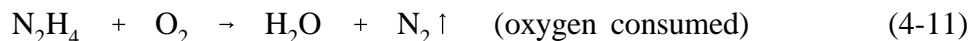

As can be seen by Reaction (4-11), no solids are formed; thus, the tendency of fouling heat transfer surfaces is reduced. An additional benefit results from the decomposition of hydrazine by the following reactions.

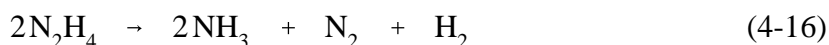

These reactions result in an alkaline pH condition that decreases corrosion in the steam facility. As can be seen in Reaction (4-15), the consumption of CO_2 takes place. Two benefits result from this reaction; 1) the inventory of dissolved gases in the steam facility is reduced, and 2) is the reaction contributes to maintaining a higher pH by eliminating carbonic acid (H_2CO_3), thus reducing corrosion.

Removal of Suspended Solids

Referring back to Figure 5 and examining the effluent of the softener, we find that both sodium salts and precipitates are present. These substances result from reactions that typically occur based on the presence of Ca^{++} and Mg^{++} salts. The chemicals most commonly used for softening are soda ash or sodium carbonate (Na_2CO_3) and hydrated lime ($\text{Ca}(\text{OH})_2$). Hard water (water containing Ca^{++} and Mg^{++} salts) contains calcium and magnesium bicarbonates ($\text{Ca}(\text{HCO}_3)_2$) and ($\text{Mg}(\text{HCO}_3)_2$), as well as calcium sulfate (CaSO_4) and magnesium chloride (MgCl_2). These impurities produce the following reactions.

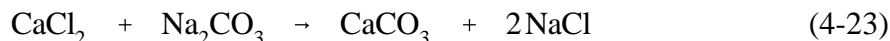
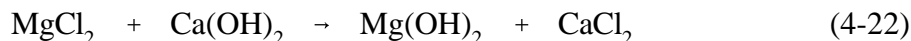
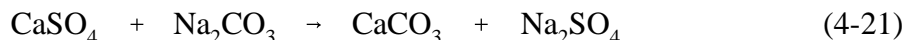
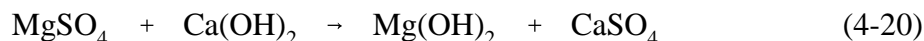

As evident from the above reactions, although Ca^{++} and Mg^{++} ions can be removed from solution, soluble sodium salts are formed. Consequently the total dissolved solid content is essentially unchanged. CaCO_3 and $\text{Mg}(\text{OH})_2$ are in precipitate form and must also be removed from the solution. One method of doing this is by filtration. Filtration is the process in which insoluble solids are removed from the water by passing them through a filter medium consisting of some type of porous material. This process will remove suspended solids and precipitates, but has no effect on dissolved solids. Numerous materials are used as filter media and include sand, activated charcoal, anthracite, diatomaceous earth, and to some extent resin in an ion exchanger. Sand is not normally used in nuclear applications because of the silicate ion (SiO_3^-) associated. Silicate ions are undesirable because they hydrolyze in water and form a weak acid, which tends to increase corrosion. Activated charcoal is often used following a chlorinator in a water treatment system because it removes excess residual chlorine as well as suspended matter.

There are two types of mechanical filters in use, gravity and pressure. Pressure filters are the most widely used because they can be installed in a pressurized system, thereby eliminating the need for additional pumps (gravity filters require pumps to provide a motive force). In addition, in a pressurized filter system, flow rate and other associated parameters can be better controlled.

Another method used for the removal of suspended corrosion products in facility fluid systems is the electromagnetic filter. These are gaining popularity in PWR feed and condensate systems where they have proven effective in reducing the crud loading of these systems, thereby reducing the inventory of corrosion products in steam generators.

Ion exchangers also function as filtration units by virtue of the size of the resin beads and the torturous path the water must follow in passing through the resin. The filtration efficiency, however, is significantly less than the ion exchange efficiency (90% or less for filtration versus approximately 100% for most ion exchange reactions). Filtration efficiency depends largely on the size of the suspended materials, with greater efficiency for the larger particles. Adverse effects of this filtration process are similar to those occurring in other types of filters. In a radioactive system, the buildup of filtered particles (crud) can increase the radiation to prohibitive levels or cause flow reductions that may necessitate removal or backwash of the resin.

pH Control

As discussed in Module 2, in reactor facilities other than those containing aluminum components or using chemical shim, reactor coolant is maintained in an alkaline condition to control corrosion in the system. In practice, if the desired alkaline condition is established, and no other action is taken, the pH gradually decreases during operation of the facility. This is due to factors such as dilution from makeup water additions to compensate for coolant losses caused by sampling, leakage, volume changes on facility cooldown, and reaction of hydroxyl ions (OH^-) with metals and corrosion products. Thus, hydroxyl ions must be added to the coolant to maintain a basic pH. The ion exchange process provides a convenient means of helping to control the pH of reactor coolant by adding OH^- ions from the exchange reactions of the resin.

A hydroxyl form anion resin, and a cation resin in some form other than the hydrogen form, may be used for this purpose as in a mixed-bed arrangement, similar to that shown in Figure 3, or in separate cation and anion units where flow is individually controlled. Usually, a portion of the reactor coolant is diverted from its normal path, passes through the ion exchange resin, and then is returned to the main coolant path. In this way, part of the coolant is constantly purified, and in the process hydroxyl ions are released to the coolant. These hydroxyl ions tend to increase the pH (or limit the decrease), thereby offsetting the effects mentioned in the preceding paragraph.

Suppose that the cation resin is in the ammonium form. As reactor coolant passes through the ion exchange system, ionic impurities will be removed and NH_4^+ and OH^- will be added. Thus, the resin serves both to purify the coolant and to help maintain the pH of the coolant by releasing NH_4OH .

The major sources of ionic impurities in reactor coolant are impurities in makeup water and corrosion products. The amount of these impurities in reactor coolant is normally very small; thus, the base added to the coolant by the ion exchange resin is usually not sufficient to entirely compensate for the losses described above. For this reason, the pH of reactor coolant is measured regularly, and additional base is added as needed. The frequency of addition varies considerably with the type of base used.

Resin Bed Malfunctions

The resin beds of ion exchangers are susceptible to malfunction from a number of causes. These causes include channeling, breakthrough, exhaustion, and overheating.

Channeling

Channeling is a condition in which the resin allows a direct flow of water through the ion exchanger. Flow channels are established from the inlet to the outlet of the ion exchanger, which allows water to flow essentially unrestricted through the resin via these paths. If channeling occurs, the water flowing through the resin bed has insufficient contact with the resin beads and results in a decrease in effectiveness of the ion exchanger.

Channeling most often results from improper filling of the ion exchanger with resin. If insufficient water is mixed with the resin when it is added, the resin column may contain pockets, or voids. These voids may then set up flow paths for channeling to occur. Improper design or malfunction of the water inlet connection (flow diffuser) can also lead to channeling.

Breakthrough and Exhaustion

To gain further insight into the processes that occur in a column of mixed bed resin as it removes an impurity, it is worthwhile to construct a series of curves such as those shown in Figure 6. These curves illustrate the behavior of hydrogen form resin as it removes NH_4^+ ions from solution (the behavior of an anion resin is analogous). The two rows of curves schematically represent the concentrations of H^+ and NH_4^+ on the resin and in the effluent (exiting solution).

In the bottom row, concentration is plotted against volume of solution that has passed through the column. That is, the plots represent the concentration of the indicated ion in the effluent solution after a volume of solution has passed through the resin. It is assumed that the concentration of NH_4^+ in the influent is constant. NH_4^+ ions are more strongly attracted to the resin than are H^+ ions. Thus, NH_4^+ ions readily exchange for H^+ ions on the resin.

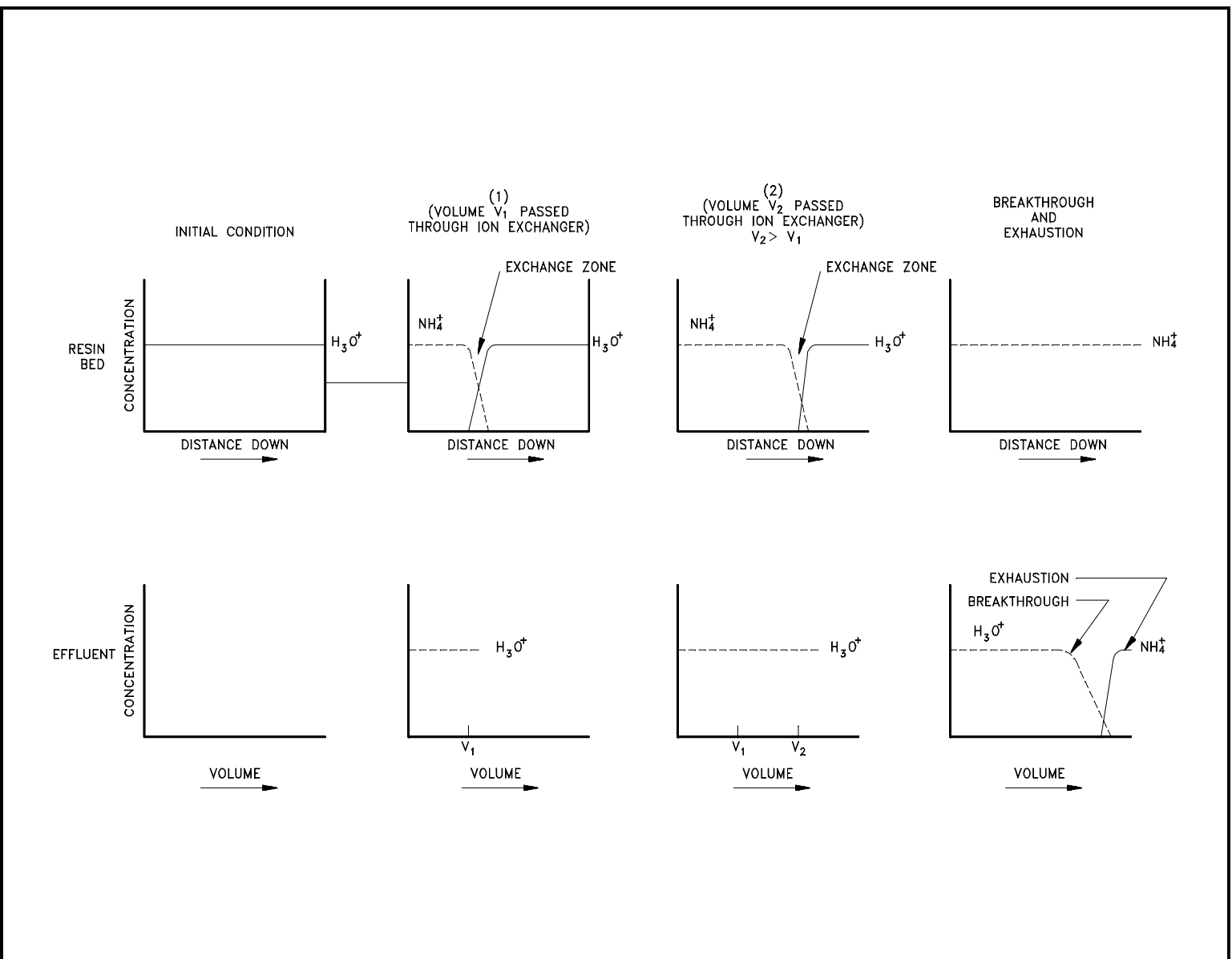

Figure 6 Behavior of Hydrogen Form Cation Exchange Bed as it Removes Ammonium Ions From Solution

As solution passes through the resin column, the relative amounts of ammonium and hydrogen ions on the resin change. The actual exchange process occurs primarily in a relatively narrow band of the column rather than over the entire length. This band is called the exchange zone. Assuming the column is vertical and that solution flows from top to bottom, the resin above the exchange zone is depleted; that is, practically all the exchange capacity has been used. Below the exchange zone, essentially none of the resin's exchange capacity has been used. As more and more solution flows through the column, the exchange zone gradually moves downward as more of the resin is depleted. Eventually, as the exchange zone approaches the end of the column, small amounts of NH_4^+ begin to appear in the effluent. The point at which this occurs is called breakthrough. If more solution passes through the resin, the concentration of NH_4^+ in the effluent increases until it is the same as the concentration in the influent. This condition is called exhaustion and indicates that essentially all the exchange capacity of the resin has been used. (Because of the equilibrium nature of the exchange process, a small amount of the resin may remain in the hydrogen form, but not enough to remove any more ionic impurities.) Note that because the exchange zone in this case was narrow, a relatively small volume of solution takes the resin from breakthrough to exhaustion.

Resin Overheating

The potential for elevated temperatures exists during most conditions of facility operation, we will examine in detail the processes that occur if the resin in an ion exchanger is overheated. Although the inert polystyrene basic structure of resin is stable up to fairly high temperatures (approximately 300°F), the active exchange sites are not. The anion resin begins to decompose slowly at about 140°F, and the decomposition becomes rapid above 180°F. The cation resin is stable up to about 250°F. Because these temperatures are well below normal reactor coolant temperatures, the temperature of the coolant must be lowered before it passes through the ion exchange resin.

The anion resin (hydroxyl form) decomposes by either of two mechanisms with approximately equal probability.

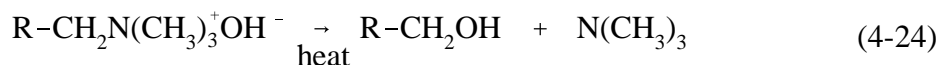

or



Reaction (4-24) produces an alcohol form of the resin, which has no exchange capability, and trimethylamine (TMA), $N(CH_3)_3$. TMA is a weak base, similar to ammonia, that reacts with water as follows.

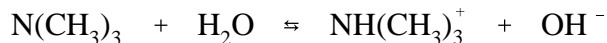

If large amounts of TMA are released to the coolant, the pH may increase noticeably. For example, 1 ppm of TMA in reactor coolant that uses lithium resin will cause a noticeable increase in pH. TMA may also interfere with the analysis for chloride ions (which is routinely performed on reactor coolant) by giving a false indication of high chloride concentration. Another significant property of TMA is its intense odor of dead fish. Although the presence of such an odor from reactor coolant is not definitive for TMA, it may give an indication of resin overheating.

The methyl alcohol (CH_3OH) produced by Reaction (4-25) is not expected to have a harmful effect on the reactor coolant system. The other product of this reaction [$R - CH_2N(CH_3)_2$] is an amine with exchange capabilities considerably less than the original form of the resin. Thus, both reactions lead to partial (or complete) loss of exchange capability. If the temperature is sufficiently high, or if a lower temperature (greater than $180^\circ F$) is sustained for a long enough period, the resin will be unfit for use.

Cation exchange resin begins to undergo thermal decomposition at temperatures above about $250^\circ F$ by the following reaction.

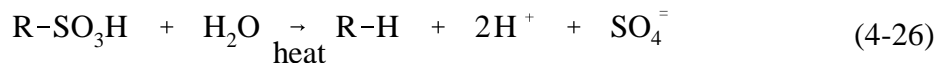

This reaction destroys all exchange capacity of the cation resin and also produces an acid. The Reactions (4-24) through (4-26) are the initial reactions when resin is overheated. If the temperature becomes very high (greater than about $450^\circ F$), the polymeric base structure of the resin will decompose, forming a complex mixture of organic tars and oils.

The preceding discussion concerned the decomposition of resins in their original forms. It should be noted that if overheating occurs after the resin has been in operation for some time, part of the resin will be in a different form due to the exchange process. As a result, some of the previously-removed impurities will be released to the coolant if decomposition occurs. For example, the chloride form of the anion resin will form CH_3Cl by the reaction corresponding to Reaction (4-25).

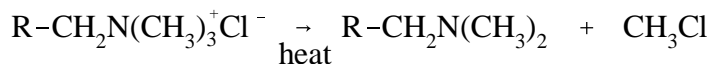

The CH₃Cl (chloromethane) will be released to the coolant and will decompose in the radiation field of the reactor core, producing Cl⁻ ions. Similarly, the sodium form of the cation resin will release Na⁺ ions by the following reactions.

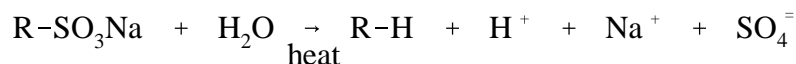

A number of changes are probable if overheating of resin occurs. Reactor coolant Cl⁻ levels would probably increase as a result of thermal breakdown and subsequent release. Ion exchanger effectiveness would be greatly reduced for similar reasons. Radioactivity levels of the reactor coolant would increase because of the release of impurities collected and later released from the resin. pH would likely decrease because of the release of H⁺ ions from the cation resin complex and may cause acidic conditions of the reactor coolant if the temperature were sufficient (>250°F). Because the anion resin decomposes at lower temperatures, pH may increase as a result of the release of TMA and be accompanied by a dead fish odor. Because of the consequences of overheated resin, stringent temperature limitations are necessary. If overheating occurs, the ion exchanger should be taken out of service immediately and the cause rectified. The resin must be replaced prior to placing the ion exchanger back in service after overheating.

Summary

The important information in this chapter is summarized below.

Dissolved Gases, Suspended Solids And pH Control Summary

- Because of the presence of impurities, raw water sources undergo treatment prior to use as makeup water in reactor facility systems. These systems normally utilize several distinct processes that remove solids, ionic impurities, and gases. Pretreatment of makeup water is necessary to reduce corrosion, minimize radiation, and limit fouling of heat transfer surfaces.
- If the hydrogen and hydroxyl forms of resin are used, the result is pure, neutral water. Other forms may be used to remove unwanted impurities from solution and substitute another substance, such as a base, to help control pH. Resins also filter solids suspended in a solution, but the efficiency for this is usually less than the efficiency for removal by ion exchange.

Dissolved Gases, Suspended Solids And pH Control Summary (Cont.)

- Dissolved gases are removed from reactor facility systems to limit corrosion by any one of the following methods or combinations of methods:

Aeration - The spraying of the water to physically release the entrained gasses, then venting the gas.

Deaeration - The heating of the water to a slow boil, then vents the gas usually to a condenser so the moisture is not lost.

Addition of scavengers - Examples are hydrogen, hydrazine, and morpholine, the scavenger combines with the gas and removes it chemically.

- Channeling in an ion exchanger occurs when there is a direct flowpath for the water that decreases the resin-water contact. Channeling may occur in the resin bed as a result of improper filling or malfunction of the inlet connection.
- Resins are susceptible to damage by overheating. Although a resin contains a very large number of exchange sites, the number is finite and the resin exchange capability is eventually depleted. The first indication of depletion is breakthrough, which occurs when impurity ions begin to appear in the solution after it has passed through the resin.
- When the concentration of impurities is the same before and after the solution passes through the resin, the resin has reached a state of exhaustion.
- Suspended solids are removed by the use of mechanical filters. The two basic categories of mechanical filters are gravity flow and pressure flow filters. The pressure flow filters are more likely to be used because there are better control capabilities. Numerous materials are used as filter media and include sand, activated charcoal, anthracite, diatomaceous earth, and to some extent the resin in an ion exchanger

WATER PURITY

The fewer the contaminants in water, the less corrosion takes place. The methods of water treatment have been explored previously. This chapter discusses how water purity is quantified. Measuring the purity helps to keep treatment effective.

EO 1.10 LIST the maximum conductivity and approximate concentration of electrolyte for each level of purity for makeup water.

Water Purity

The water used in a nuclear facility must be of a purity level that is consistent with the overall objectives of chemistry control in the facility.

There are a number of ways in which pure water is obtained, including distillation systems and pretreatment systems similar to those mentioned earlier in this module. Regardless of the method employed, the required purity must be achieved.

Water purity has been defined in many different ways, but one generally accepted definition states that high purity water is water that has been distilled and/or de-ionized so that it will have a specific resistance of 500,000 ohms (2.0 micromhos conductivity) or greater. This definition is satisfactory as a base to work from, but for more critical requirements, the breakdown shown in Table 3 has been suggested to express degrees of purity.

TABLE 3 Water Purity		
Degree of Purity	Maximum Conductivity (μ mhos/cm)	Approximate Concentration of Electrolyte, mg/l
Pure	10	2 - 5
Very Pure	1	0.2 - 0.5
Ultrapure	0.1	0.01 - 0.02
Theoretically Pure	0.054	0.00

Conductivity is a measure of the ease with which electricity can be passed through a substance. The presence of ions greatly facilitates the passage of an electric current. Pure water is only slightly ionized by the dissociation of water: $\text{H}_2\text{O} \rightarrow \text{H}^+ + \text{OH}^-$. At 25°C, the concentration of the hydrogen and hydroxyl ions is 10^{-7} moles/liter.

The equivalent conductance of hydrogen (H) is

$$350 \frac{\text{mhos-cm}^2}{\text{equivalent}}$$

and the equivalent conductance of OH is

$$192 \frac{\text{mhos-cm}^2}{\text{equivalent.}}$$

A mho is a measure of the ease with which electric current will pass and is the inverse of an ohm, the measure of resistance to the passage of electric current. Conductance and conductivity are similar qualities (conductivity is measured in $\mu\text{mhos/cm}$, so conductance must be converted to conductivity). A μmho is one millionth of a mho. The total conductivity of pure water can be calculated by adding the equivalent conductances of H and OH, multiplying by the normality (see Module 1 for definition), and then multiplying by 10^{-3} l/cm³ and 10^6 $\mu\text{mhos/mho}$. For theoretically pure water this becomes the following.

$$(350 + 192) \frac{\text{mhos-cm}^2}{\text{equiv}} \times 10^{-7} \frac{\text{equiv}}{\text{liter}} \times 10^{-3} \frac{\text{liters}}{\text{cm}^3} \times 10^6 \frac{\mu\text{mhos}}{\text{mho}} = .054 \frac{\mu\text{mho}}{\text{cm}}$$

The conductivity limit for demineralized water is 1 $\mu\text{mho/cm}$.

Conductivity will very quickly indicate the presence of any ionic impurities, even if the impurity concentration is extremely small. As an example, suppose 1.0 mg of NaCl impurity were deposited in 1 liter of demineralized water. The normality of this solution would be as follows.

$$1 \times 10^{-3} \frac{\text{gm}}{\text{liter}} \times \frac{1 \text{ equivalent}}{58 \text{ gm}} = \frac{1}{58} \times 10^{-3} \frac{\text{equivalent}}{\text{liter}} = 1.7 \times 10^{-5} \frac{\text{equivalent}}{\text{liter}}$$

The equivalent conductance of Na^+ is $51 \frac{\text{mhos} \cdot \text{cm}^2}{\text{equivalent}}$, while the equivalent conductance of Cl^- is $75 \frac{\text{mhos} \cdot \text{cm}^2}{\text{equivalent}}$. The conductivity of the solution is

$$(51 + 75) \frac{\text{mhos} \cdot \text{cm}^2}{\text{equivalent}} \times 1.7 \times 10^{-5} \frac{\text{equivalent}}{\text{liter}} \times 10^{-3} \frac{\text{liter}}{\text{cm}} \times 10^6 \frac{\mu\text{mho}}{\text{mho}} = 2.2 \frac{\mu\text{mho}}{\text{cm}},$$

which is well above the limit. Even extremely low concentrations of ionic impurities can easily be detected. The most probable cause is a depleted or damaged resin bed that is no longer capable of removing ionic contaminants. The depleted bed should be removed from service, and a fresh resin bed placed in service.

For most applications in nuclear facilities, the specification that is identified as Very Pure ($1.0 \mu\text{mho}/\text{cm}$ maximum conductivity) is used. Ultra Pure demineralized water is normally only required in laboratory situations and is mentioned for information purposes only.

Summary

The important information in this chapter is summarized below.

Water Purity Summary		
Water Purity is clarified below.		
<u>Degree of Purity</u>	<u>Maximum Conductivity($\mu\text{mhos}/\text{cm}$)</u>	<u>Approximate Concentration of Electrolyte, mg/l</u>
Pure	10	2 - 5
Very Pure	1	0.2 - 0.5
Ultrapure	0.1	0.01 - 0.02
Theoretically Pure	0.054	0.00

**Department of Energy
Fundamentals Handbook**

CHEMISTRY
Module 5
Hazards of Chemicals and Gases

TABLE OF CONTENTS

LIST OF FIGURES	ii
LIST OF TABLES	iii
REFERENCES	iv
OBJECTIVES	v
CORROSIVES (ACIDS AND ALKALIES)	1
Acids	1
Alkalies	2
General Safety Precautions	2
Summary	6
TOXIC COMPOUND	8
Toxic Compounds	8
Summary	15
COMPRESSED GASES	16
Compressed Gases	16
Basic Safety Precautions Regarding Compressed Gases	19
Cryogenic Liquids	20
Treating Cold-Contact Burns	23
Specific Properties of Selected Industrial Gases	24
Hydrogen	25
Nitrogen	25
Oxygen	26
Sources of Ignition	26
Summary	27
FLAMMABLE AND COMBUSTIBLE LIQUIDS	30
Flammable and Combustible Liquids Definitions	30
Safety Precautions	33
Storage	39
Summary	42

LIST OF FIGURES

Figure 1 Excerpt of Toxic Substance List	11
Figure 2 Typical Material Safety Data Sheet (Sections I-IV)	13
Figure 3 Typical Material Safety Data Sheet (Sections V-VIII)	14
Figure 4 DOT Flammable Liquid Labels	32
Figure 5 Typical Static-Producing Situations, Including Charge Separation In Pipe	34
Figure 6 Bonding and Grounding	35
Figure 7 Grounding Above-Ground Storage Tanks	36
Figure 8 Bonding During Container Filling	38
Figure 9 Storage Container With Spring-Loaded Cover	39
Figure 10 A Flammable Liquids Mixing and Storage Room	40

LIST OF TABLES

Table 1 Safety Properties of Cryogenic Fluids 22

Table 2 Emergency Measures for Treating Cold-Contact Burns 23

REFERENCES

- Donald H. Andrews and Richard J. Kokes, Fundamental Chemistry, John Wiley & Sons, Inc., 1963
- Compressed Gas Association, Inc., Handbook of Compressed Gases, 2nd Edition, Reinhold Publishing Corporation, 1981.
- R. A. Day, Jr. and R. C. Johnson, General Chemistry, Prentice Hall, Inc., 1974.
- Dickerson, Gray, Darensbourg and Darensbourg, Chemical Principles, 4th Edition, The Benjamin Cummings Publishing Company, 1984.
- Academic Program for Nuclear Plant Personnel, Volume II, Chemistry, Columbia, MD, General Physics Corporation, Library of Congress Card #A 326517, 1972.
- General Physics Corporation, Fundamentals of Chemistry, General Physics Corporation, 1982.
- Glasstone and Sesonske, Nuclear Reactor Engineering, 3rd Edition, Van Nostrand Reinhold Company, 1981.
- McElroy, Accident Prevention Manual for Industrial Operations Engineering and Technology, Volume 2, 8th Edition, National Safety Council, 1980.
- Sienko and Plane, Chemical Principles and Properties, 2nd Edition, McGraw and Hill, 1974.
- Underwood, Chemistry for Colleges and Schools, 2nd Edition, Edward Arnold, Ltd., 1967.
- Norman V. Steere and Associates, CRC Handbook of Laboratory Safety, 2nd Edition, CRC Press, Inc., 1971.

TERMINAL OBJECTIVE

- 1.0 Without references, **DISCUSS** the hazards associated with chemicals (liquid and gas) found in a nuclear plant.

ENABLING OBJECTIVES

- 1.1 **STATE** the hazards associated with the use of corrosives.
- 1.2 **STATE** the general safety precautions necessary for the handling, storage, and disposal of corrosives.
- 1.3 **LIST** the general safety precautions regarding toxic compounds.
- 1.4 **LIST** the criteria used to determine if a compound is a health hazard.
- 1.5 **STATE** the methods by which toxic compounds may enter the body.
- 1.6 **SUMMARIZE** the purpose and general contents of the following:
- a. Material Safety Data Sheets (MSDS)
 - b. Toxic Substance List
- 1.7 **DEFINE** the following terms:
- a. Compressed gas
 - b. Non-liquified gases
 - c. Liquified gases
 - d. Dissolved gases
- 1.8 **STATE** the five major families of gases.
- 1.9 **STATE** the general safety precautions regarding the use, handling, and storage of gases.
- 1.10 **STATE** the safety precautions for working with cryogenic liquids.
- 1.11 **LIST** the physical properties and special precautions for the following gases:
- a. Hydrogen
 - b. Oxygen
 - c. Nitrogen

ENABLING OBJECTIVES (Cont.)

- 1.12 **DEFINE** the following terms:
- a. Flammable liquid
 - b. Combustible liquid
- 1.13 **STATE** general safety precautions regarding the use, handling, and storage of flammable and combustible liquids.
- 1.14 **STATE** the reasons for and techniques used in bonding and grounding of flammable liquid containers.
- 1.15 **LIST** four sources of ignition of flammable liquids.
- 1.16 **STATE** the health hazards associated with flammable and/or combustible liquids.

CORROSIVES (ACIDS AND ALKALIES)

There are two basic groups of corrosives: acids and alkalies. These chemicals require precautions for safe handling. These precautions will be discussed in this chapter.

EO 1.1 STATE the hazards associated with the use of corrosives.

EO 1.2 STATE the general safety precautions necessary for the handling, storage, and disposal of corrosives.

Acids

Acids are compounds of hydrogen and one or more other elements (with the exception of carbon) that dissociate or break down to produce hydrogen ions (H^+) when dissolved in water or certain other solvents.

Acids are corrosive in any form, and in high concentrations destroy body tissue and cause severe burns on contact with the skin. The eyes are very susceptible, and permanent damage or loss of sight may result from contact with acids. The inhalation of excessive concentrations of vapor or mist is extremely irritating to the respiratory system and to mucous membranes in particular. Accidental swallowing of concentrated acids may result in severe irritation of, and damage to, the throat and stomach which, in some cases, may prove fatal. Some of these materials are specifically poisonous as well as irritating. In lower concentrations, repeated skin contact may result in inflammation.

Concentrated aqueous solutions of acids are not in themselves flammable. The potential hazard is the danger of their mixture with other chemicals or combustible materials which may result in fire or explosion. Acids also react with many metals resulting in the liberation of hydrogen, a highly flammable gas, which upon ignition in air may cause an explosion. Some of the acids are strong oxidizing agents and can react destructively and violently when in contact with organic or other oxidizable materials.

Personnel exposure requiring immediate action usually involves direct contact of the acid with the body or eyes of the individual, inhalation of acid vapors or decomposition products, and ingestion of acid. The initial treatment in all cases of local contact is immediate removal of the acid with a large amount of water. This treatment must be prolonged until all traces of acid have been removed, usually a minimum washing time of 15 minutes.

Alkalies

Alkalies (bases) are corrosive caustic substances that dissociate in water and yield hydroxyl ions (OH^-). Alkalies include: ammonia, ammonium hydroxide; calcium hydroxide and oxide; potassium, potassium hydroxide and carbonate; sodium, sodium hydroxide; carbonate, peroxide and silicate; and trisodium phosphate.

The alkalies, whether in solid form or concentrated liquid solution, are more destructive to tissue than most acids. Alkali dusts, mists, and sprays may cause irritation of the eyes and respiratory tract and lesions of the nasal septum. Strong alkalies combine with tissue, causing severe burns, frequently deep ulceration, and ultimate scarring. Severe burns result not only from contact with solid alkalies, but also from solutions of these compounds. Potassium and sodium hydroxide are the most active materials in this group. Even dilute solutions of the stronger alkalies tend to soften the epidermis (skin) and emulsify or dissolve the skin fats. Exposure to atmospheres contaminated with alkalies may result in damage to the upper respiratory tract and to lung tissue, depending upon the severity of the exposure. The effects of inhalation may vary from mild irritation of the nasal mucous membranes to severe inflammation of the lungs.

Ingestion causes severe damage to mucous membranes or deeper tissues with which contact is made. Perforation of these tissues may follow, or there may be severe and extensive scar formation. Death may result if penetration into vital areas occurs.

Even though alkalies are not flammable and will not support combustion, much heat is evolved when the solid material is dissolved in water. Therefore, cold water must be used to dissolve solid alkalies, otherwise the solution may boil, and splatter corrosive liquid over a wide area.

General Safety Precautions

Corrosives are available in numerous forms and varying concentrations. Some forms and concentrations are more hazardous than others, but the potential for serious accidents exists regardless of the substance in question.

Many of the safety precautions necessary for safe handling and storage are equally applicable to acids and alkalies. Some of the more common precautions are contained in this section. These precautions are not all inclusive, nor are they meant to be. Specific corrosives may require specific precautions, and Material Safety Data Sheets (MSDS) must be consulted in all cases. The MSDS will be discussed later in this module.

Safety in handling hazardous chemicals depends to a great extent upon effective employee education, proper safety practices, intelligent supervision, and the use of safe equipment. Workers should be thoroughly informed of the hazards that may result from improper handling. Each employee should know what to do in an emergency and should be fully informed about proper first-aid measures. Hazards from spills and leaks should be minimized by an adequate supply of water for washing-down. Drainage of hard-surfaced or diked areas should be directed to minimize the exposure of personnel and equipment. Adequate ventilation should be provided in areas where chemical mist or dust is present.

Alkalies are much more injurious to the eyes than acids because strong acids tend to precipitate a protein barrier, which prevents further penetration into the tissue. The alkalies do not do this. They continue to soak into the tissue as long as they are allowed to remain in contact with the eye. The end result of a corrosive burn to the eye (alkali or acid) is usually a scar on the cornea and possible permanent damage.

Speed in removing corrosives is of primary importance. If the chemical enters the eyes, they should be copiously irrigated with water for at least 15 minutes, and a physician should be consulted immediately. In case of contact with skin or mucous membranes, the safety shower should be used immediately. Clothing can be removed under the shower. Contaminated skin areas should be washed with very large quantities of water for 1 to 2 hours, or until medical help arrives. The ready availability of water, particularly safety showers and eye-washing baths, greatly minimizes the possibility of severe, extensive damage. Contaminated clothing and shoes should be thoroughly washed and decontaminated before re-use.

The use of personal protective equipment is not intended as a substitute for adequate control measures, but because corrosives can cause extensive damage to the body this equipment must be available as needed. During handling operations where spills or splashes are possible, whole body protection (eyes, head, body, hands, and feet) may be necessary. All personal protective equipment should be carefully cleaned and stored following use, and any equipment that cannot be decontaminated should be discarded.

For the protection of the eyes, chemical safety goggles should be worn. Face shields should be worn if complete face protection is necessary. Eyewash fountains and safety showers must be available at any location where eye and/or skin contact may occur. Protection against mist or dust can be provided by proper respiratory protective equipment. The wearing of protective clothing is also advisable to avoid skin contact. This may consist of rubber gloves, aprons, shoes or boots, and cotton coveralls which fit snugly. Safety shoes or boots made of rubber, chlorobutadiene, or other chemical-resistant materials with built-in steel toecaps are recommended for workers handling drums or in process areas where leakage may occur. Containers should be stored in rooms with trapped floor drains. Curbs or a drained gutter, covered with an appropriate grill, should be constructed at door openings where floor drains are not provided.

Tanks should be entered for cleaning or repairing only after these have been drained, flushed thoroughly with water, ventilated, and sampled. Workers entering tanks should be monitored by someone on the outside of the tank. A supplied-air respirator or self-contained breathing apparatus, together with rescue harness and lifeline, should be on hand for rescue purposes.

Removal from exposure is the primary, and most important, step where exposure by inhalation is involved. The individual should be made as warm and comfortable as possible, and a physician should be called immediately.

Ingestion, the least common mode of contamination, requires immediate medical attention. Any attempt at first aid beyond drinking large quantities of water should be made only upon the advice of a physician.

If body burns are severe or extensive, or if the eyes are in any way involved, a physician should be consulted as soon as possible after first aid is rendered. No attempt should be made to neutralize the corrosive prior to treatment with water. Any treatment, in addition to the use of water, should be undertaken only with the advice of the physician.

When corrosives are shipped in small containers such as glass or polyethylene bottles, they should be well protected, whether individually packaged or several are packaged in a single case. After careful inspection, the corrosives may be stored in these containers if the containers are maintained in an upright position and under cover. The containers should be kept off the floor on materials that are corrosive resistant, or protected with corrosive-resistant coverings, to facilitate flushing and other cleanup procedures in the event of leakage or spills.

All drums should be stored on individual racks or securely blocked on skids, with the closure (plug) up to prevent leakage. Drums containing corrosives in liquid form should be vented when received, and at least weekly thereafter, to relieve accumulated internal pressure.

Cylinders should be stored in an upright position, preferably in individual racks and with the valve protective cap in place. In all cases, to avoid error, empty and full containers should be stored in different locations.

Under no circumstance should corrosives be transferred from the original labeled container to an unmarked container. All containers must be labeled clearly, concisely, and in simple, easily understood terms. Inspection of containers before handling will disclose conditions such as breakage, leakage, and improperly positioned closures which could readily cause a leak or spill.

In handling bottles, barrels, or drums containing corrosives, the following guidelines must be followed.

1. Carefully inspect containers prior to handling.
2. Use personal protective equipment.
3. Use equipment specifically designed for the purpose of transporting and dispensing the chemical in question.
4. Label all containers into which the chemical is transferred.

Properties of corrosives make several considerations mandatory in the selection of a storage site.

1. The building, or area within the building selected, should be of fire-resistant construction.
2. The floors should be composed of chemical-resistant brick or treated concrete, be washable, and be provided with adequate drainage.
3. A well-lit and ventilated area in which there are adequate outlets for water should be provided.
4. A relatively cool and dry environment should be maintained, preventing extremes of temperature and humidity.
5. Electrical fixtures should be protected against corrosive mists, and wiring should be enclosed and covered with corrosive-resistant material.

The nature of the corrosive will determine the manner in which it is stored. Most acids should, to some extent, be isolated, some from all other chemicals, some from certain other acids and oxidizable materials such as oil and grease, and some from combustible materials.

Generally, adequate natural ventilation is sufficient in areas where corrosives are stored, that is, where the containers remain unopened. Where acid is used in work areas where dust or mists may arise (such as in processing equipment or tanks), some form of mechanical exhaust system must be provided.

Transporting containers within the plant and dispensing at various points throughout the plant are two high-risk procedures that may cause an accident. Proper equipment can be readily obtained, which precludes the necessity of using makeshift or otherwise dangerous methods of transportation.

Handtrucks or power trucks used for transporting containers should have lifting parts, or clamps specially designed for that purpose. If bottles must be transported in the plant or laboratory, they should be enclosed in safety bottle carriers that prevent breakage if the bottle is struck or dropped. All containers (especially acid) must be opened slowly and cautiously because of the possible buildup of pressure within the container. Corrosives may be dispensed from drums by means of siphons, drum transfer pumps, or by gravity with the use of a special fitting, such as a self-closing faucet. Under no circumstances should bottles or drums be subjected to air pressure to expel the contents.

One final, and extremely important, consideration is the type of container or receptacle into which corrosives are to be dispensed. The use of an inappropriate or makeshift receptacle can negate the value of all precautionary measures.

These receptacles may be used for temporary storage or merely as a means of transporting from storage area to place of use. In any event, an appropriate receptacle meets several conditions.

1. It is designed for the application.
2. It is used for no other purpose than that for which it is intended.
3. It is maintained in a safe, clean, and dry condition.

Summary

The important information in this chapter is summarized below.

Corrosives Summary

- The hazards of acids:

High concentrations can destroy body tissue, eyes being especially susceptible with permanent damage or loss of sight.

Inhalation of acidic vapors can irritate the respiratory system.

Ingestion can destroy the stomach and throat lining, and if the concentration is strong enough, ingestion can be fatal.

Aqueous solutions can become explosive if combined with other chemicals or combustible materials

If reacting with metal, hydrogen gas may be a byproduct, which is very explosive.

Corrosives Summary (Cont.)

- The hazards of alkalis:

Alkalis are more destructive than the acids.

Alkali dusts, mists, and sprays can cause irritation of nasal passages, eyes, and respiratory tract.

When in contact with the tissue, strong alkalis will cause ulcers, severe burns, and eventual scarring.

Ingestion causes perforations of the mucous membrane and deeper tissues; death may result if penetration is in vital areas.

- Precautions when using corrosives:

An adequate supply of washdown water must be available.

Proper ventilation in corrosive work area must be provided.

Proper drainage must be provided such that exposure is limited.

Face shields and safety glasses that protect the eyes from splashes and extensive vapor should be worn.

Proper personnel safety equipment should be worn when appropriate (chemical gloves, respirators, coveralls, etc.)

- Precautions when storing corrosives:

The building, or area within the building selected, should be of fire-resistant construction.

The floors should be composed of chemical-resistant brick or treated concrete, be washable, and be provided with adequate drainage.

A well-lit and ventilated area in which there are adequate outlets for water should be provided.

A relatively cool and dry environment should be maintained, preventing extremes of temperature and humidity.

Electrical fixtures should be protected against corrosive mists, and wiring should be enclosed and covered with corrosive-resistant material.

TOXIC COMPOUNDS

The various chemicals found in industry as well as the home are useful when properly applied. If the user is uninformed about correct applications, storage, and potential hazards, these chemicals become threats to safety. This chapter gives an overview of handling chemicals and resources of information about these chemicals.

- EO 1.3** **LIST the general safety precautions regarding toxic compounds.**
- EO 1.4** **LIST the criteria used to determine if a compound is a health hazard.**
- EO 1.5** **STATE the methods by which toxic compounds may enter the body.**
- EO 1.6** **SUMMARIZE the purpose and general contents of the following:**
- a.** **Material Safety Data Sheets (MSDS)**
 - b.** **Toxic Substance List**

Toxic Compounds

Because the types of toxic compounds found in industry number in the thousands, and because specific hazards, controls, and corrective measures may vary with the substance, no attempt will be made in this section to address specific compounds. Instead, information of a general nature will be presented on toxic materials. Material Safety Data Sheets (MSDS) are required for all potentially hazardous and toxic materials and should be consulted for specific descriptions and precautions concerning the substance in question.

There are some general precautions that should be universally employed regarding toxic compounds. Many of these precautions are consistent with those already mentioned concerning corrosives. Proper ventilation, appropriate hygienic practices, housekeeping, protective clothing, and training for safe handling and storage will diminish many of the hazards that exist.

The toxicity of a material is not synonymous with its health hazard. *Toxicity* is the capacity of a material to produce injury or harm to a living organism.

Hazard is the possibility that a material will cause injury when a specific quantity is used under specific conditions. Several key elements are considered when evaluating a health hazard.

- Toxicity of the materials used
- Physical properties of these materials
- Absorption probabilities of these materials by individuals
- Extent and intensity of exposure to these materials
- Control measures used

Toxicity is relative. It refers to a harmful effect on some biologic mechanism. The term toxicity is commonly used in comparing one chemical agent with another, but such comparison is meaningless if the biologic mechanism, and the conditions under which the harmful effects occur, are not specified.

Although the toxic effects of many chemical agents used in industry are well known, the toxic effects of many other commonly used chemical agents are not as well defined. The toxicity of a material is not a physical constant (such as boiling point, melting point, or temperature); therefore, only a general statement can be made concerning the harmful nature of a given chemical agent.

Many chemical agents are nonselective in their action on tissue or cells; they may exert a harmful effect on all living matter. Other chemical agents may act only on specific cells. Another agent may be harmful only to certain species; other species may have built-in protective devices.

The degree to which a substance will affect living cells can be measured only after recognizable changes have occurred following absorption. Some changes (impaired judgment, delayed reaction time) may be produced at levels too low to cause actual cell damage. Toxicity is dependent upon the dose, rate, method, and site of absorption, and many other factors including general state of health, individual differences, tolerance, diet, and temperature.

In general, industrial poisonings usually result from inhalation, ingestion, and absorption.

- The inhalation and absorption of toxic agents by the lungs is dependent upon the solubility in body fluids, the diffusion through the lungs, the volume of inhalation, the volume of blood in the lungs, and the concentration gradient of vapors between the inhaled air and the blood.
- Ingestion of the toxic agent can occur to some extent; however, there would generally be considerable inhalation of the material where such conditions exist.

- Absorption through the skin can occur upon exposure to some toxic agents. Some liquids and vapors are known to pass through the skin in concentrations high enough such that respiratory protection is not adequate. For example, hydrogen cyanide (HCN) is known to pass through the unbroken skin. Consideration should be given to the type of work clothes being worn; if they become saturated with solvents, they will act as a reservoir to bathe the body continually with the harmful material.

Most volatile (easily vaporized) organic compounds are eliminated from the body in a matter of hours or, at most, days. Many of the poisonous elements, however, can be stored for long periods of time in various parts of the body. Chronic (long term) toxicity damage is unlikely to have an even distribution throughout the body. In toxicity studies with radioactive isotopes, the organ which suffers the most severe damage and appears to contribute most to the toxic effect on the body as a whole, is called the critical organ. The particular organ that shows the largest amount of damage is the one that is chosen for estimating the effect.

Industrial poisoning may be classified as either acute or chronic. The classification is based on the rate of intake of harmful materials, rate of onset of symptoms, and the duration of symptoms.

Acute poisoning is characterized by rapid absorption of the material and sudden, severe exposure. For example, inhaling high levels of carbon monoxide or swallowing a large quantity of cyanide compound will produce acute poisoning. Generally, acute poisoning results from a single dose which is rapidly absorbed and damages one or more of the vital physiological processes. The development of cancer long after recovery from acute radiation damage is called a delayed acute effect.

Chronic poisoning is characterized by absorption of a harmful material in small doses over a long period of time; each dose, if taken alone, would barely be effective. In chronic poisoning, the harmful materials remain in the tissues, continually injuring a body process. The symptoms in chronic poisoning are usually different from the symptoms seen in acute poisoning by the same toxic agent.

The Occupational Safety and Health Act of 1970 requires that the Health and Human Services publish at least annually, a list of all known toxic substances by generic family, or other useful grouping, and the concentrations at which such toxicity is known to occur. Under the OSHA Act, the Secretary of Labor must issue regulations requiring employers to monitor employee exposure to toxic materials and to keep records of any such exposure.

The purpose of The Toxic Substances List is to identify "all known toxic substances" in accordance with definitions that may be used by all sections of our society to describe toxicity. An excerpt of this list is illustrated in Figure 1. It must be emphatically stated that the presence of a substance on the list does not automatically mean that it is to be avoided. A listing does mean, however, that the substance has the documented potential of being hazardous if misused, and, therefore, care must be exercised to prevent tragic consequences.

TABLE Z-1-CONTINUED			TABLE Z-1-CONTINUED		
SUBSTANCE	p/m ^a	mg./M ^{3b}	SUBSTANCE	p/m ^a	mg./M ^{3b}
RONNEL		15	O-TOLUIDINE-SKIN	5	22
ROTENONE (COMMERCIAL)		5	TOXAPHENE SEE CHLORINATED		
SELENIUM COMPOUNDS (AS Se)		0.2	CAMPHENE		
SELENIUM HEXAFLUORIDE	0.05	0.4	TRIBUTYL PHOSPHATE		5
SILVER, METAL, AND SOLUBLE COMPOUNDS		0.01	1,1,1-TRICHLOROETHANE, SEE METHYL CHLOROFORM		
SODIUM FLUOROACETATE (1080)-SKIN		0.05	1,1,2-TRICHLOROETHANE-SKIN	10	45
SODIUM HYDROXIDE		2	TITANIUMDIOXIDE		1.5
STIBINE	0.1	0.5	TRICHLOROMETHANE, SEE CHLOROFORM		
STODDARD SOLVENT	500	2,900	TRICHLORANAPHTHALENE-SKIN		5
STRYCHNINE		0.15	1,2,3-TRICHLOROPROPANE	50	300
SULFUR DIOXIDE	5	13	1,1,2-TRICHLORO 1,2,2-TRIFLUOROETHANE	1,000	7,600
SULFUR HEXAFLUORIDE	1,000	6,000	TRIETHYLAMINE	25	100
SULFURIC ACID		1	TRIFLUOROMONOBROMOMETHANE	1,000	6,100
SULFUR MONOCHLORIDE	1	6	2,4,6-TRINITROPHENOL SEE PICRIC ACID		
SULFUR PENTAFLUORIDE	0.025	0.25	2,4,6-TRINITROPHENYLMETHYL-NITRAMINE, SEE TETRYL		
SULFURYL FLUORIDE	5	20	TRINITROTOLUENE-SKIN		1.5
SYSTOX, SEE DEMETON® 2,4,5T		10	TRIORTHOCRESYL PHOSPHATE		0.1
TANTALUM		5	TRIPHENYL PHOSPHATE		3
TEBP-SKIN		0.2	TURPENTINE	100	560
TELLURIUM		0.1	URANIUM (SOLUBLE COMPOUNDS)		0.05
TELLURIUM HEXAFLUORIDE	0.02	0.2	URANIUM (INSOLUBLE COMPOUNDS)		0.25
TEPP-SKIN		0.05	C VANADIUM		
C TERPHENYLS	1	9	V ₂ O ₅ DUST		0.5
1,1,1,2-TETRACHLORO-2,2-DIFLUOROETHANE	500	4,170	V ₂ O ₅ FUME		0.1
1,1,2,2-TETRACHLORO-2,2-DIFLUOROETHANE	500	4,170	VINYL BENZENE SEE STYRENE		
1,1,2,2-TETRACHLOROETHANE-SKIN	5	35	VINYLCYANIDE SEE ACRYLONITRILE		
TETRACHLOROMETHANE, SEE CARBON TETRACHLORIDE			VINYL TOLUENE	100	480
TETRACHLORONAPHTHALENE-SKIN		2	WARFARIN		0.1
TETRAETHYL LEAD (AS Pb)-SKIN		0.075	XYLENE (XYLOL)	100	435
TETRAHYDROFURAN	200	590	XYLIDINE-SKIN	5	25
TETRAMETHYL LEAD (AS Pb)-SKIN		0.075	YTRIUM		1
TETRAMETHYL SUCCINONITRILE-SKIN	0.5	3	ZINC CHLORIDE FUME		1
TETRANITROMETHANE	1	8	ZINC OXIDE FUME		5
TETRYL (2,4,6-TRINITROPHENYL-METHYL-NITRAMINE)-SKIN		1.5	ZIRCONIUM COMPOUNDS (AS Zr)		5
THALLIUM (SOLUBLE COMPOUNDS)-SKIN AS Tl		0.1			
THIRAM		5			
TIN (INORGANIC CMPDS, EXCEPT OXIDES)		2			
TIN (ORGANIC CMPDS)		0.1			
C TOLUENE-2,4-DIISOCYANATE	0.02	0.14			

†THIS STANDARD APPLIES IN COTTON YARN MANUFACTURING UNTIL COMPLIANCE WITH § 1910.1043 (c) AND (e) IS ACHIEVED

a PARTS OF VAPOR OR GAS PER MILLION PARTS OF CONTAMINATED AIR BY VOLUME AT 25° C AND 760mm Hg PRESSURE

b APPROXIMATE MILLIGRAMS OF PARTICULATE PER CUBIC METER OF AIR (NO FOOTNOTE "c" IS USED TO AVOID CONFUSION WITH CEILING VALUE NOTATIONS)

d AN ATMOSPHERIC CONCENTRATION OF NOT MORE THAN 0.02 P.P.M. OR PERSONAL PROTECTION MAY BE NECESSARY TO AVOID HEADACHE

MATERIAL	8-HOUR TIME WEIGHTED AVERAGE	ACCEPTABLE CEILING CONCENTRATION	ACCEPTABLE MAXIMUM PEAK ABOVE THE ACCEPTANCE CEILING CONCENTRATION FOR AN 8-HOUR SHIFT	
			CONCENTRATION	MAXIMUM DURATION
BENZENE (Z37.40-1969)	10 P.P.M.	25 P.P.M.	50 P.P.M.	10 MINUTES
BERYLLIUM AND BERYLLIUM COMPOUNDS (Z37.29-1970)	2µ G./M ³	5µ G./M ³	25µ G./M ³	30 MINUTES
CADMIUM FUME (Z37.5-1970)	0.1 MG/M ³	0.3 MG/M ³		
CADMIUM DUST (Z37.5-1970)	0.2 MG/M ³	0.6 MG/M ³		
CARBON DISULFIDE (Z37.3-1968)	20 P.P.M.	30 P.P.M.	100 P.P.M.	30 MINUTES
CARBON TETRACHLORIDE (Z37.17-1967)	10 P.P.M.	25 P.P.M.	200 P.P.M.	5 MINUTES IN ANY 4 HOURS
CHROMIC ACID AND CHROMATES (Z37.7-1971)		1 MG/10M ³		

Figure 1 Excerpt of Toxic Substance List

The absence of a substance from the list does not necessarily indicate that a substance is not toxic. Some hazardous substances may not qualify for the list because the dose that causes the toxic effect is not known.

Other chemicals associated with skin sensitization and carcinogenicity (ability to cause cancer) may be omitted from the list, because these effects have not been reproduced in experimental animals or because the human data is not definitive.

It is not the purpose of the list to quantify the hazard by way of the toxic concentration or dose that is presented with each of the substances listed. Hazard evaluation involves far more than the recognition of a toxic substance and a knowledge of its relative toxic potency. It involves a measurement of the quantity that is available for absorption by the user, the amount of time that is available for absorption, the frequency with which the exposure occurs, the physical form of the substances, and the presence of other substances, additives, or contaminants (toxic or non-toxic).

The purpose of the Material Safety Data Sheet (MSDS) is to ensure the individuals working with chemicals and in the vicinity of chemicals have specific information on these chemicals. This form identifies the chemical by its technical and common name and lists the physical/chemical characteristics and fire, explosion, and reactivity hazards. The second page specifies health hazards and recommends first aid procedures. The safe handling and control measures are also supplied. The MSDS is a very helpful document, and personnel working around chemicals should make it a practice to review these sheets frequently for their own safety. Figures 2 and 3 are copies of the MSDS.

The Code of Federal Regulations recommends that the hazards of all chemicals produced and imported be evaluated and the information concerning the hazards be transmitted to the employers and employees. The MSDS, labels on containers, and employee training should be part of a comprehensive hazards communication program.

Section V - Reactivity Data			
Stability	Unstable		Conditions to Avoid
	Stable		
Incompatibility (Materials to Avoid)			
Hazardous Decomposition or Byproducts			
Hazardous Polymerization	May Occur		Conditions to Avoid
	Will Not Occur		
Section VI - Health Hazard Data			
Route(s) of Entry:	Inhalation?	Skin?	Ingestion?
Health Hazards (<i>Acute and Chronic</i>)			
Carcinogenicity:	NTP?	IARC Monographs?	OSHA Regulated?
Signs and Symptoms of Exposure			
Medical Conditions Generally Aggravated by Exposure			
Emergency and First Aid Procedures			
Section VII - Precautions for Safe Handling and Use			
Steps to Be Taken in Case Material is Released or Spilled			
Waste Disposal Method			
Precautions to Be Taken in Handling and Storing			
Other Precautions			
Section VIII - Control Measures			
Respiratory Protection (<i>Specify Type</i>)			
Ventilation	Local Exhaust	Special	
	Mechanical (General)	Other	
Protective Gloves		Eye Protection	
Other Protective Clothing or Equipment			
Work/Hygienic Practices			

Page 2

★ USGPO 1986-491-529/45775

Figure 3 Typical Material Safety Data Sheet (Sections V-VIII)

Summary

The important information in this chapter is summarized below.

Toxic Compounds Summary

- The general safety precautions regarding toxic compounds:
 - Proper ventilation
 - Appropriate hygienic practices
 - Housekeeping
 - Protective clothing
 - Training
- The criteria used to determine if a compound is a health hazard:
 - Toxicity of the materials used
 - The physical properties
 - The absorption probabilities of these materials by individuals
 - The extent and intensity of exposure to these materials
 - The control measures used
- The methods by which toxic compounds may enter the body:
 - Ingestion
 - Inhalation
 - Absorption
- The purpose and general contents of the Material Safety Data Sheets (MSDS) is to ensure the individuals working with and in the vicinity of chemicals have specific information of these chemicals. This form identifies the chemical, by technical and common name, lists the physical/chemical characteristics, any fire or explosion hazard as well as reactivity hazards. The second page will specify health hazards and recommend first aid procedures. The safe handling and control measures are also supplied.
- The purpose and general contents of the Toxic Substance List is to identify "all known toxic substances" in accordance with definitions that may be used by all sections of our society to describe toxicity. This form identifies known toxic chemicals which have been proven in lab tests or have definite human data. It lists the chemical name, level of concentration at which it is hazardous, concentration limits for set time exposures both weighted averages and ceiling limits.

COMPRESSED GASES

Gases are commonly used throughout industry. These gases come in several forms and are often as dangerous as they are useful. This chapter provides background knowledge of these gases.

EO 1.7 DEFINE the following terms:

- | | |
|--------------------------------------|----------------------------------|
| a. Compressed gas | c. Liquified gases |
| b. Non-liquified gases | d. Dissolved gases |

EO 1.8 STATE the five major families of gases.

EO 1.9 STATE the general safety precautions regarding the use, handling, and storage of gases.

EO 1.10 STATE the safety precautions for working with cryogenic liquids.

EO 1.11 LIST the physical properties and special precautions for the following gases:

- a. Hydrogen**
- b. Oxygen**
- c. Nitrogen**

Compressed Gases

Gases in compressed form serve countless indispensable roles in modern technology. Oxygen is used extensively to produce stronger and cheaper steels. Acetylene welding and brazing of certain metals has been common for many years. Other compressed, flammable gases such as hydrogen are equally necessary for the welding of certain metals. Some metals and alloys (such as stainless steel, titanium, and zirconium) can be welded only under an inert gas atmosphere. Carbon dioxide is used extensively in fire extinguishers for chemical and electrical fires. In the nuclear industry, uses of compressed gases range from the addition of nuclear grade hydrogen to reactor plant systems to propane and butane for heating components or spaces.

Gases are compressed for practical reasons of transportation, storage and use. The definition of *compressed gas* by the Interstate Commerce Commission (ICC) reads: "... any material or mixture having in the container an absolute pressure exceeding 40 psi (pounds per square inch) at 70°F, or regardless of the pressure at 70°F, having an absolute pressure exceeding 140 psi at 130°F; or any flammable material having a vapor pressure exceeding 40 psi at 100°F."

Because we often deal in gage pressures, and absolute pressure is equal to atmospheric pressure (14.7 psi at sea level) plus the pressure that would be read on an ordinary gage, we can simplify the above definition. Accordingly, a compressed gas is one that gives a pressure reading of:

1. either 25 psig (pounds per square inch gage) at 70°F; or 125 psig at 130°F; or
2. if the contained substance is flammable, 25 psig at 100°F.

This simplified definition and the range of boiling points among gases classify gases into two major groups that differ in physical state when contained.

1. *Non-liquified gases*, which are gases that do not liquify in containers at ambient temperatures and under pressures attained in commercially used containers that range to 2000 to 2500 psig.
2. *Liquified gases*, which are gases that do become liquids to a very large extent in containers at ordinary ambient temperatures and at pressures from 25 to 2500 psig.

The first group, commonly called non-liquified gases, have relatively low boiling points, approximately -150°F or lower.

Non-liquified gases do, however, become liquids if cooled to temperatures below their boiling points. Those that liquify at "cryogenic" temperatures (from absolute zero [-459.7°F] to around -240°F) are known as cryogenic fluids.

The second group, or liquified gases, have boiling points relatively near atmospheric temperatures (from about -130°F to 30°F). The liquified gases solidify at cryogenic temperatures.

Oxygen, helium and nitrogen are examples of gases in wide use both as non-liquified gases and cryogenic fluids. With respective boiling points of -297°F, -425°F, and -320°F, they are charged into high pressure steel cylinders at more than 2000 psig at 70°F for shipment and use as non-liquified gases. However, when shipped as cryogenic fluids, they are cooled down to liquid form and charged into special insulated containers that keep them below their boiling points and are contained at pressures normally less than 75 psig.

A third physical state in the container is represented by only one widely used gas, acetylene. Acetylene is sometimes referred to as a *dissolved gas*. A dissolved gas is defined as a gas that is dissolved into a solution.

The industry recommends that free acetylene should not ordinarily be handled at pressures greater than 15 psig because, if handled at higher pressures without special equipment, it can decompose with explosive violence. Consequently, acetylene cylinders are packed with an inert porous material that is saturated with acetone. Acetylene charged into the cylinder dissolves in the acetone and in solution will not decompose at or below the maximum authorized shipping pressure of 250 psig at 70°F.

Compressed or liquified gases are also often described according to loosely-knit families to which they belong through common origins, properties, or uses. The major families of gases are atmospheric gases, fuel gases, refrigerant gases, aerosol gases, and poison gases.

Atmospheric gases comprise one family. Its most abundant member is nitrogen, constituting 78 percent of air by volume; oxygen, constituting 21 percent of air by volume, is its second most abundant member. Most of the remaining 1 percent of the atmosphere consists of a sub-family of gases, the inert gases, that share the property of chemical inertness. Inert gases are chiefly argon, with minute quantities of helium, neon, krypton, xenon and radon. The last four are frequently called the rare gases due to their scarcity. Hydrogen also occurs minutely in the atmosphere, as do a large variety of trace constituents, small amounts of carbon dioxide, and large amounts of water vapor.

Another family of gases are the fuel gases. Fuel gases burned in air or with oxygen to produce heat make up a large family related through their major use. Its members are notably the hydrocarbons including liquefied petroleum (LP) gases, propane, butane, methane, and welding gases such as acetylene and hydrogen.

An opposite application relates members of another large family, the refrigerant gases. A refrigerant gas liquifies easily under pressure and works by being compressed to a liquid which then absorbs large amounts of heat as it circulates through coils where it vaporizes back into gaseous form. Examples of refrigerant gases include ammonia and the fluorocarbons (freon).

Aerosol propellant gases make up a family also related by use through the introduction of pressure-packaged products used in the form of a spray or a foam. Propellant gases have moderate vapor pressures at room temperatures (70 psig down to 35 psig, and even lower in some cases). It is usually agreed that a good propellant should also be nontoxic, chemically stable, noncorrosive, and inexpensive. The fluorocarbons (freon) and nitrous oxide are the most commonly used propellant gases.

Gases considered to be members of the poison gas family are generally those that the ICC has classified as poison gases to ensure public safety in interstate shipments. Two examples of these gases are hydrogen cyanide and phosgene.

Basic Safety Precautions Regarding Compressed Gases

Compressed and liquified gases are widely useful due to properties including high heat output in combustion for some gases, high reactivity in chemical processing with other gases, extremely low temperatures available from some gases, and the economy of handling them all in compact form at high pressure or low temperature. These same properties, however, also represent hazards if the gases are not handled with full knowledge and care.

Practically all gases can act as simple asphyxiants by displacing the oxygen in air. The chief precaution taken against this potential hazard is adequate ventilation of all enclosed areas in which unsafe concentrations may build up. A second precaution is to avoid entering unventilated areas that might contain high concentrations of gas without first putting on breathing apparatus with a self-contained or hose-line air supply. A number of gases have characteristic odors which can warn of their presence in air. Others, however, like the atmospheric gases, have no odor or color. Warning labels are required for compressed and liquified gas shipping containers. Similar warning signs are placed at the approaches to areas in which the gases are regularly stored and used.

Some gases can also have a toxic effect on the human system, either inhalation, through high vapor concentrations, or by liquified gas coming in contact with the skin or the eyes. Adequate ventilation of enclosed areas serves as the chief precaution against high concentrations of gas. In addition, for unusually toxic gases, automatic devices can be purchased or built to monitor the gas concentration constantly and set off alarms if the concentration approaches a danger point. Precautions against skin or eye contact with liquified gases that are toxic or very cold, or both, include thorough knowledge and training for all personnel handling such gases, the development of proper procedures and equipment for handling them, and special protective clothing and equipment (for example, protective garments, gloves, and face shields).

With flammable gases, it is necessary to guard against the possibility of fire or explosion. Ventilation, in addition to safe procedures and equipment to detect possible leaks, represents a primary precaution against these hazards. If fire breaks out, suitable fire extinguishing apparatus and preparation will limit damage. Care must also be taken to keep any flammable gas from reaching any source of ignition or heat (such as sparking electrical equipment, sparks struck by ordinary tools, boiler rooms, or open flames).

Oxygen poses a combustible hazard of a special kind. Although oxygen does not ignite, it lowers the ignition point of flammable substances and greatly accelerates combustion. It should not be allowed closer than 10 feet to any flammable substance, including grease and oil, and should be stored no closer than 10 feet to cylinders or tanks containing flammable gases.

Proper storage and handling of containers avoids many possible incidents. Hazards resulting from the rupture of a cylinder or other vessel containing gas at high pressure are protected against by careful and secure handling of containers at all times. For example, cylinders should never be struck nor allowed to fall, because if the cylinder is charged to a high pressure and the cylinder valve is broken off, it could become a projectile. Cylinders should not be dragged or rolled across the floor; they should be moved by a hand truck. Also, when they are upright on a hand truck, floor, or vehicle, they should be chained securely to keep them from falling over. Moreover, cylinders should not be heated to the point at which any part of their outside surface exceeds a temperature of 125°F, and they should never be heated with a torch or other open flame. Similar precautions are taken with larger shipping and storage containers. Initial protection against the possibility of vessel rupture is provided by the demanding requirements and recommendations that compressed gas containers fulfill in their construction, testing and retesting.

Cryogenic Liquids

Most cryogenic liquids are colorless, odorless, and tasteless when vaporized to a gas. As liquids, most have no color (except liquid oxygen which is light blue). However, whenever the cold liquid and vapor are exposed to the atmosphere a warning appears. As the boil-off gases condense moisture in the air, a fog forms that extends over an area larger than the vaporizing gas. Many cryogenic liquids are inert gases, and may inert an enclosed space. Inert gases will not support life.

Both the liquid and its boil-off vapor can rapidly freeze human tissue and can cause many common materials such as carbon steel, plastic, and rubber to become brittle or fracture under stress. Liquids in containers and piping at temperatures at or below the boiling point of liquified air (-318°F) can cause the surrounding air to condense to a liquid.

Extremely cold liquified gases (helium, hydrogen, and neon) can even solidify air or other gases to which they are directly exposed. In some cases, plugs of ice or foreign material will develop in cryogenic container vents and openings and cause the vessel to rupture. If a plug forms, contact the supplier immediately. Do not attempt to remove the plug; move the vessel to a remote location.

All cryogenic liquids produce large volumes of gas when they vaporize. For example, 1 volume of saturated liquid nitrogen at 1 atmosphere vaporizes to 696.5 volumes of nitrogen gas at room temperature at 1 atmosphere.

When vaporized in a sealed container, cryogenic liquids produce enormous pressures. If 1 volume of liquid helium at 1 atmosphere is warmed to room temperature and vaporized in a totally enclosed container, it has the potential to generate a pressure of more than 14,500 psig. Because of this high pressure, cryogenic containers are usually protected with two pressure-relief devices, a pressure-relief valve and a frangible (easily broken) disk.

Many safety precautions that must be taken with compressed gases also apply to liquified gases. However, some additional precautions are necessary because of the special properties exhibited by fluids at cryogenic temperatures.

The properties of cryogenic liquids affect their safe handling and use. Table 1 presents information to help determine safe handling procedures. None of the gases listed are corrosive at ambient temperatures, and only carbon monoxide is toxic.

- Always handle cryogenic liquids carefully. They can cause frostbite on skin and exposed eye tissue. When spilled, they tend to spread, covering a surface completely and cooling a large area. The vapors emitted by these liquids are also extremely cold and can damage tissues. The vapor boil-off may inert the immediate vicinity.
- Stand clear of boiling or splashing liquid and its vapors. Boiling and splashing occurs when a warm container is charged or when warm objects are inserted into a liquid. These operations should always be performed slowly to minimize boiling and splashing. If cold liquid or vapor comes in contact with the skin or eyes, first aid should be given immediately.
- Never allow an unprotected part of the body to touch uninsulated pipes or vessels that contain cryogenic fluids. The extremely cold metal will cause the flesh to stick fast to the surface and tear when withdrawn. Touching even nonmetallic materials at low temperatures is dangerous.

Tongs, or a similar device, should be used to withdraw objects immersed in a cryogenic liquid. Materials that are soft and pliable at room temperature become hard and brittle at extremely low temperatures and will break easily.

Workers handling cryogenic liquids should use eye and hand protection to protect against splashing and cold-contact burns. Safety glasses are also recommended. If severe spraying or splashing is likely, a face shield or chemical goggles should be worn. Protective gloves should always be worn when anything that comes in contact with cold liquids and their vapors is being handled. Gloves should be loose fitting so that they can be removed quickly if liquids are spilled into them. Trousers should remain outside of boots or work shoes.

TABLE 1
Safety Properties of Cryogenic Fluids

	Xenon (Xe)	Krypton (Kr)	Methane (CH ₄)	Oxygen (O ₂)	Argon (Ar)	Carbon Monoxide (CO)	Nitrogen (N ₂)	Neon (Ne)	Hydrogen (H ₂)	Helium (He)
Boiling Point, 1 atm °F	-163	-244	-259	-297	-303	-313	-321	-411	-423	-425
°C	-108	-153	-161	-183	-186	-192	-196	-246	-253	-268
Melting Point, 1 atm °F	-169	-251	-296	-362	-309	-341	-346	-416	-435	N/A
°C	-112	-157	-182	-219	-189	-207	-210	-249	-259	
Density, boiling point, 1 atm lb/cu ft	191	151	26	71	87	49	50	75	4.4	7.8
Heat of vaporization boiling point Btu/lb	41	46	219	92	70	98	85	37	193	10
Volume expansion ratio, liquid at 1 atm boiling point to gas at 60° F, 1 atm	559	693	625	881	841	N/A	697	1447	850	754
Flammable	No	No	Yes	N/A	No	Yes	No	No	Yes	No

Treating Cold-Contact Burns

Workers will rarely come in contact with a cryogenic liquid if proper handling procedures are used. In the unlikely event of contact with a liquid or cold gas, a cold-contact "burn" may occur. Actually, the skin or tissue freezes. Medical assistance should be obtained as soon as possible. In the interim, the emergency measures presented in Table 2 are recommended.

TABLE 2
Emergency Measures for Treating Cold-Contact Burns

- Remove any clothing that may restrict circulation to the frozen area. Do not rub frozen parts, as tissue damage may result.
- As soon as practical, immerse the effected part in warm water (not less than 105°F or more than 115°F, or 40°C to 46°C). Never use dry heat. The victim should be in a warm room, if possible.
- If the exposure has been massive and the general body temperature is depressed, the patient should be totally immersed in a warm-water bath. Treatment for shock should be provided.
- Frozen tissues are painless and appear waxy and yellow. They will swell and be painful and prone to infection when thawed. Do not rewarm rapidly. Thawing may require 15 to 60 minutes and should continue until the pale blue tint of the skin turns pink or red. Morphine or tranquilizers may be required to control the pain during thawing and should be administered under professional medical supervision.
- If the frozen part of the body thaws before the doctor arrives, cover the area with dry sterile dressings and a large, bulky protective covering.
- Alcoholic beverages and smoking decrease blood flow to the frozen tissues and should be prohibited. Warm drinks and food may be administered.

Some liquified gases require special precautions. For example, when liquid oxygen is handled, all combustible materials, especially oil or gases, should be kept away. Smoking or open flames should never be permitted where liquid oxygen is stored or handled. NO SMOKING signs should be posted conspicuously in such areas.

Liquid oxygen, or oxygen-rich air atmospheres, should not come in contact with organic materials or flammable substances. Some organic materials (oil, asphalt, kerosene, cloth, or dirt containing oil or grease) react violently with oxygen, and may be ignited by a hot spark. Liquid oxygen may form mixtures that are shock sensitive with fuels, oils, or grease. If liquid oxygen spills on asphalt, or on another surface contaminated with combustibles (for example, oil-soaked concrete or gravel), no one should walk on, and no equipment should pass over, the area for at least 30 minutes after all frost or fog has disappeared.

Any clothing that has been splashed or soaked with liquid oxygen, or exposed to a high gaseous-oxygen atmosphere, should be changed immediately. The contaminated systems should be aired for at least an hour so that they are completely free of excess oxygen. Workers exposed to high-oxygen atmospheres should leave the area and avoid all sources of ignition until the clothing and the exposed area have been completely ventilated. Clothing saturated with oxygen is readily ignitable and will burn vigorously.

Specific Properties of Selected Industrial Gases

Anyone who uses gases must have a thorough knowledge of their chemical properties to maintain a controlled operation. If the gas is flammable, its flammable range and ignition temperature must be known.

The lower flammable limit is the smallest percent of the gas in air which can ignite when exposed to the ignition temperature. The upper flammable limit is the point above which the mixture is too rich in fuel to ignite. The range between these two limits is the flammable, or explosive, range. The most violent explosion will occur at concentrations about the middle of the flammable range. Sources of heat that may cause temperatures that exceed the ignition temperature must be avoided, as well as gas-air mixtures that are within the flammable range.

The physiological effects of the gas must be known, not only types of reactions, but also severity of reactions. All employees who handle gas should be familiar with its effects, and recommended control measures.

The chemical reactivity of the gas must be known. This includes a knowledge of the materials that are resistant to its chemical effects, the materials with which it reacts, and how it reacts with such materials. Some gases become unstable at high pressures, and others become more corrosive at high temperatures.

The term Threshold Limit Value (TLV) is sometimes used and is defined as: The highest time-weighted average concentration of an air contaminant which if breathed for a normal working day is unlikely to result in health injury to the average person, either at the time, or after years of exposure.

The following discussion addresses some of the more commonly used gases, and describes the specific chemical properties and characteristics that are important for accident prevention.

Hydrogen

Hydrogen (H₂) is the lightest of all elements. Its presence cannot be detected by any of the senses. It is flammable in oxygen or air, and has a flammable range of from 4.1 percent to 74.2 percent by volume in air. A mixture of 10 to 65 percent hydrogen by volume in air will explode if ignited. Pure hydrogen burns quietly in air with an almost invisible flame, and when burned with pure oxygen, a very high temperature may be reached. Hydrogen will burn readily in chlorine gas, and under proper conditions, will combine with nitrogen, forming ammonia.

Some chemical reactions produce hydrogen as a byproduct. A lead-acid battery will produce hydrogen when it is being charged. Metallic sodium and potassium are examples of some chemicals that react violently when exposed to water, producing hydrogen, which may flame spontaneously due to the heat of the reaction. Many electroplating processes produce hydrogen. Some chemicals used to remove scale from the water side of boilers give off hydrogen. Whatever the operation, it is important to know whether hydrogen will be produced, and if so, precautions must be taken to prevent its accumulation and ignition. The precautions to take include adequate ventilation to prevent its accumulation and the elimination of possible sources of ignition. Hydrogen is classified as an asphyxiant.

Nitrogen

Nitrogen (N₂) makes up more than 78 percent of the earth's atmosphere. It will not burn or support combustion. It cannot be detected by any of the senses and it is not toxic. Although it is often referred to as an inert gas because it does not oxidize readily, it nevertheless forms many compounds. It is frequently used to inert systems that contain, or have contained, flammable liquids or gases. Inerting a system means replacing the oxygen with an inert gas in order to reduce the possibility of fire or explosion.

Nitrogen is fairly soluble in the blood, and a considerable amount will dissolve in the blood of a person when the air pressure is increased, as in diving, caisson, and some tunnel work. If these employees are not properly decompressed, the dissolved nitrogen escapes from the blood in the form of small bubbles in the bloodstream causing intense pain and is often fatal. This disorder is commonly known as the bends.

If a large amount of nitrogen were released into the air of an enclosed space, it could cause a serious oxygen deficiency. Nitrogen is an asphyxiant.

Oxygen

Oxygen (O₂) supports combustion, but does not burn. Even so, it must be considered a potentially hazardous element from a fire hazard standpoint. The results of an enriched oxygen atmosphere include a lowered ignition temperature, an increased flammable range, and an acceleration of the burning rate. Oxygen readily combines with other elements and compounds, with spontaneous ignition in some cases. When oxygen comes in contact with oil, grease, or fuel oils, it may ignite violently. Every possible precaution must be taken to prevent this combination.

Oxygen sustains life, but if pure oxygen were inhaled continuously for extended periods, the reactions in the body would be too rapid and would cause harmful effects. Oxygen should always be referred to as oxygen, and not air, to prevent confusion. It should never be used to run pneumatic equipment because of the possibility of coming in contact with oil that may be inside the equipment. Finally, oxygen valves should be operated slowly. Abruptly starting and stopping oxygen flow may ignite contaminants in the system.

Sources of Ignition

All known sources of ignition must be eliminated in areas that contain, or may contain, flammable gases. This includes areas where gases are being manufactured or used in some process and in areas where they are stored.

One potential source of ignition is electrical equipment. When used or installed in hazardous locations, this equipment must be explosion-proof and properly installed.

Electrical equipment includes not only the more obvious equipment such as motors, generators, motor controls, switches, and lighting fixtures, but also the not so obvious equipment such as alarm systems, remote controls, telephones and other communication systems.

The use of unapproved portable electric tools and equipment should be strictly prohibited in hazardous locations. When temporary lighting is used, it must be an approved type and in excellent repair.

All possible sources of static electricity should be anticipated to prevent its buildup and discharge. Several methods of control may be used. It is necessary that conductive parts of a system be bonded (described in the following chapter) together to eliminate the difference in potential between the parts, and the whole system grounded to eliminate the difference in potential between the system and ground.

When some gases come in contact with certain other substances, spontaneous ignition may occur. One of the better known of these reactions is that of oxygen with oil. Another reaction is the possible ignition of hydrogen due to the heat of the reaction which liberated it, such as sodium in water. Additional sources of ignition are as follows.

- The spontaneous ignition that may occur in oily rags and other materials.
- Smoking is a principal cause of fire, and calls for strict prohibition in hazardous areas.
- Other sources of ignition include sparks or flame-producing operations such as grinding or welding, and equipment such as heaters or boilers.
- Ferrous handtools can produce a spark when struck against, or by a suitable object, and may cause ignition of some gas-air mixtures.
- Other possible sources of ignition are internal combustion engines and battery-powered electric vehicles.

The most disastrous accidents involving industrial gases have been caused by ignition of gas-air mixtures. Fires cannot occur without three essential factors being present in the right quantity, at one place, and at the same time. These factors are fuel, heat, and oxygen (which is normally supplied by air). When they are present in the same place, in the right amounts, and at the same time, there will be a fire. To prevent a fire, it is necessary to keep only one of these factors away from the other two. Air is necessary for life and cannot normally be eliminated, but the fuel and heat can be kept separated. Proper operational and maintenance procedures will help prevent a flammable gas from escaping into the air, but because this is always a possibility, it is most important to eliminate the source of ignition.

Summary

The important information in this chapter is summarized below.

Compressed Gases Summary

- The following terms are defined:

Compressed gas is defined as any material or mixture having in the container an absolute pressure exceeding 40 psi (pounds per square inch) at 70°F, or regardless of the pressure at 70°F, having an absolute pressure exceeding 140 psi at 130°F; or any flammable material having a vapor pressure exceeding 40 psi at 100°F.

Compressed Gases Summary (Cont.)

Non-liquified gases are gases that do not liquify in containers at ambient temperatures and under pressures attained in commercially used containers that range to 2000 to 2500 psig.

Liquified gases are gases which do become liquids to a very large extent in containers at ordinary ambient temperatures, and at pressures from 25 to 2500 psig.

Dissolved gases are gases dissolved into a solution.

- The major families of gases are:

atmospheric gases

aerosol gases

fuel gases

poison gases

refrigerant gases

- The general safety precautions for gases:

Ensure there is adequate ventilation of enclosed areas.

Avoid entering unventilated areas that might contain high concentrations of gas without first putting on breathing apparatus with a self-contained or hose-line air supply.

Take precautions against skin or eye contact with liquified gases that are toxic or very cold, or both.

The proper storage and handling of containers avoids many possible incidents.

- The safety precautions for working with cryogenic liquids are:

Stand clear of boiling or splashing liquid and its vapors.

Never allow an unprotected part of the body to touch uninsulated pipes or vessels that contain cryogenic fluids.

Use tongs, or a similar device, to withdraw objects immersed in a cryogenic liquid.

Use appropriate eye and hand protection.

Compressed Gases Summary (Cont.)

- The physical properties and special precautions for hydrogen include the following:

It is the lightest of all elements

It cannot be detected by any of the senses

It has a flammable range of from 4.1 percent to 74.2 percent by volume in air

It burns with an almost invisible flame

- Hydrogen is classified as an asphyxiant, and special precautions, such as adequate ventilation and the elimination of possible sources of ignition, should be taken to prevent hydrogen accumulation.

- The physical properties and special precautions for nitrogen include the following:

It makes up more than 78 percent of the earth's atmosphere

It will not burn or support combustion

It cannot be detected by any of the senses

It is used to inert systems that contain, or have contained, flammable liquids or gases

It is fairly soluble in the blood and if the dissolved nitrogen escapes from the blood in the form of small bubbles in the bloodstream, intense pain occurs and effects are often fatal

- Nitrogen is an asphyxiant and it could cause a serious oxygen deficiency. Special precautions, such as adequate ventilation, should be taken to prevent nitrogen accumulation.

- The physical properties and special precautions for oxygen include the following:

It supports combustion, but does not burn

Ignition temperature of a combustible material is lower in enriched oxygen

It readily combines with other elements and compounds, with spontaneous ignition in some cases

- When oxygen comes in contact with oil, grease, or fuel oils, it may ignite violently. Every possible precaution must be taken to prevent this combination. If pure oxygen were inhaled continuously for extended periods the reactions in the body would be too rapid and cause harmful effects. Finally, oxygen valves should be operated slowly. Abruptly starting and stopping oxygen flow may ignite contaminants in the system.

FLAMMABLE AND COMBUSTIBLE LIQUIDS

One of the most devastating industrial accidents is an explosion resulting in fire. Carelessness is often the root cause. Improper handling and storage can also lead to disastrous results. This chapter introduces precautions taken to avoid accidents with flammable and combustible liquids.

EO 1.12 DEFINE the following terms:

- a. Flammable liquid**
- b. Combustible liquid**

EO 1.13 STATE general safety precautions regarding the use, handling, and storage of flammable and combustible liquids.

EO 1.14 STATE the reasons for and techniques used in bonding and grounding of flammable liquid containers.

EO 1.15 LIST four sources of ignition of flammable liquids.

EO 1.16 STATE the health hazards associated with flammable and/or combustible liquids.

Flammable And Combustible Liquids Definitions

As defined by OSHA, DOT, and the National Fire Protection Association Standard, Flammable and Combustible Liquids Code, NFPA 30, a *flammable liquid* is one having a flash point below 100°F, and having a vapor pressure not exceeding 40 psia at 100°F. *Combustible liquids* are those with flash points at or above 100°F, but below 200°F. Although combustible liquids do not ignite as easily as flammable liquids, they must be handled with caution because of their ability to ignite under certain conditions. Flammable and combustible liquids are further subdivided by NFPA 30 into classes as follows.

- Class I - Those liquids having flash points below 100°F.
 - IA - Those liquids having flash points below 73°F and having a boiling point below 100°F.
 - IB - Those liquids having flash points below 73°F and having a boiling point at or above 100°F.

- IC - Those liquids having flash points at or above 73°F and below 100°F.
- Class II - Those liquids having flash points at or above 100°F and below 140°F.
- Class III - Those liquids having flash points above 140°F.
- IIIA - Those liquids having flash points at or above 140°F and below 200°F.
- IIIB - Those liquids having flash points above 200°F.

Flammable and combustible liquids vaporize to form flammable mixtures when they are stored in open containers, when they leak or are spilled, or when heated. The hazard that exists from these mixtures is largely dependent upon the flash point of the liquid, the concentration of the mixture, and the potential of a source of ignition at a temperature sufficient to cause the mixture to burst into flame.

Since it is the vapor-air mixture formed from the evaporation of the liquid that poses the hazard, exposures of large liquid surface areas and sources of heat should be avoided or prevented during handling or storage of these liquids.

Some of the commonly used terms associated with flammable and combustible liquids are provided below.

- Auto-Ignition Temperature -
The minimum temperature at which a flammable mixture will ignite from its own heat source or contact with a heated surface without necessity of a spark or flame.
- Flash Point -
The minimum temperature at which a liquid gives off vapor in sufficient concentration to form an ignitable mixture with air near the surface of the liquid (under controlled test conditions).
- Flammable Limits -
The minimum concentration of vapor in air below which propagation of flame does not occur on contact with a source of ignition. This is known as the lower flammable limit (LFL). There is also a maximum concentration of vapor or gas in air above which propagation of flame will not occur. This is called the upper flammable limit (UFL).
- Flammable Range -
The difference between the lower and upper flammable limits, expressed in percentage of vapor or gas in air by volume. Also known as the explosive range.
- Propagation of Flame -
The spread of flame through the entire volume of the flammable mixture from a single source of ignition.

- Volatility -
The tendency or ability of a liquid to vaporize.
- Oxygen Limits -
The concentration of oxygen below which a normally flammable vapor mixture will not ignite (normally 12 to 14 percent oxygen). An increase of pressure or temperature will reduce the required lower oxygen limit, however.
- Rate of Diffusion -
The tendency of one gas or vapor to disperse into or mix with another gas or vapor. Dependent upon the density of the vapor or gas as compared to air.
- Vapor Pressure -
The pressure exerted by a volatile liquid under any of the conditions of equilibrium that may exist between the vapors and the liquid.
- Oxygen Deficiency -
The designation given to an atmosphere containing less than the percentage of oxygen normally found in air (<21%).

The volatility of liquids will increase as heat is applied to them. Accordingly, combustible liquids should be treated as flammable when they are heated even though the liquid, when not heated, is outside the flammable range.

The Department of Transportation (DOT) has modified the definition of flammable liquids in its Hazardous Materials Regulation, 49 CFR parts 170 to 179. They are defined as any liquid that gives off flammable vapors at or below a temperature of 80°F. This definition is important because the DOT Flammable Liquid Label, illustrated in Figure 4, is one means by which containers of flammable liquids can be identified for shipping, receiving, and transportation.

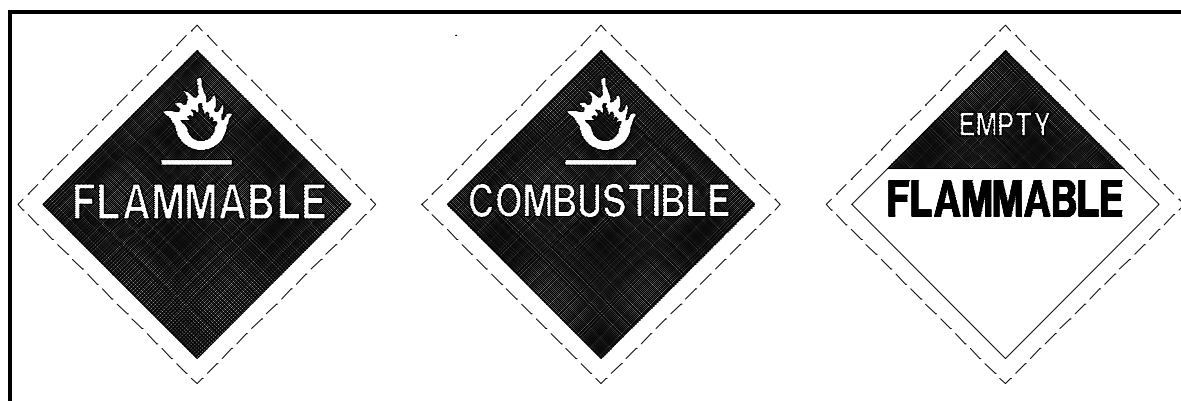

Figure 4 DOT Flammable Liquid Labels

Safety Precautions

Avoid accidental mixture of flammable and combustible liquids. A small amount of a highly volatile substance may lower the flash point of a less volatile substance and form a more flammable mixture. In addition, the lower flash point liquid can act as a fuse to ignite the higher flash point material in the same manner as if it were a flammable mixture.

Fill and discharge lines and openings, as well as control valves associated with flammable and combustible systems, shall be identified by labels, color coding, or both, to prevent mixing different substances. All storage tanks shall be clearly labeled with the name of its contents, and products stored within shall not be intermixed. Transfer lines from different types and classes of flammable products should be kept separate, and preferably, different pumps should be provided for individual products.

For handling quantities of flammable liquids up to five gallons, a portable FM (Factory Mutual Engineering Corp.) or UL (Underwriters Laboratory) approved container should be used. The container should be clearly identified by lettering or color code.

Smoking, the carrying of strike-anywhere matches, lighters, and other spark-producing devices should not be permitted in a building or area where flammable liquids are stored, handled, or used. The extent of the restricted area will depend on the type of products handled, the design of the building, local codes, and local conditions.

Suitable NO SMOKING signs should be posted conspicuously in those buildings and areas where smoking is prohibited.

Static electricity is generated by the contact and separation of dissimilar material. For example, static electricity is generated when a fluid flows through a pipe or from an orifice into a tank. Examples of several methods of generating static electricity are shown in Figure 5. The principal hazards created by static electricity are fire and explosion, which are caused by spark discharges.

A point of great danger from a static spark is where a flammable vapor is present in the air, such as the outlet of a flammable liquid fill pipe, at a delivery hose nozzle, near an open flammable liquid container, and around a tank truck fill opening. In the presence of a mechanism for generating a static charge, a spark between two bodies occurs when there is a poor electrical conductive path between them. Hence, grounding or bonding of flammable liquid containers is necessary to prevent static electricity from causing a spark.

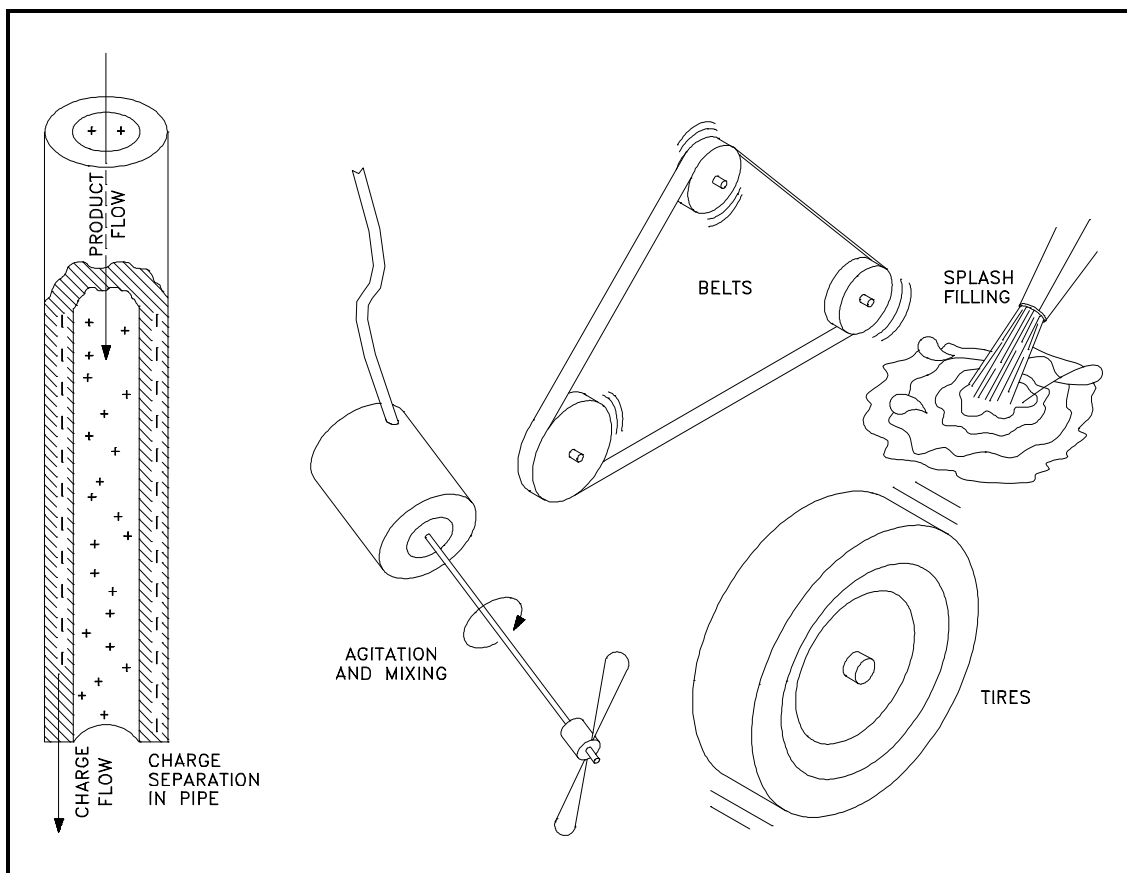

Figure 5 Typical Static-producing Situations, Including Charge Separation in Pipe

The terms bonding and grounding have sometimes been used interchangeably because of a poor understanding of the terms. As illustrated in Figure 6, bonding eliminates a difference in potential between objects. Grounding eliminates a difference in potential between an object and ground. Bonding and grounding are effective only when the bonded objects are conductive.

When two objects are bonded, the charges flow freely between the bodies, and there is no difference in their charge. Therefore, the likelihood of sparking between them is eliminated.

Although bonding eliminates a difference in potential between the objects that are bonded, it does not eliminate a difference in potential between these objects and the earth unless one of the objects possesses an adequate conductive path to earth. Therefore, bonding will not eliminate the static charge, but will equalize the potential between the objects bonded so that a spark will not occur between them.

An adequate ground will discharge a charged conductive body continuously and is recommended as a safety measure whenever any doubt exists concerning a situation.

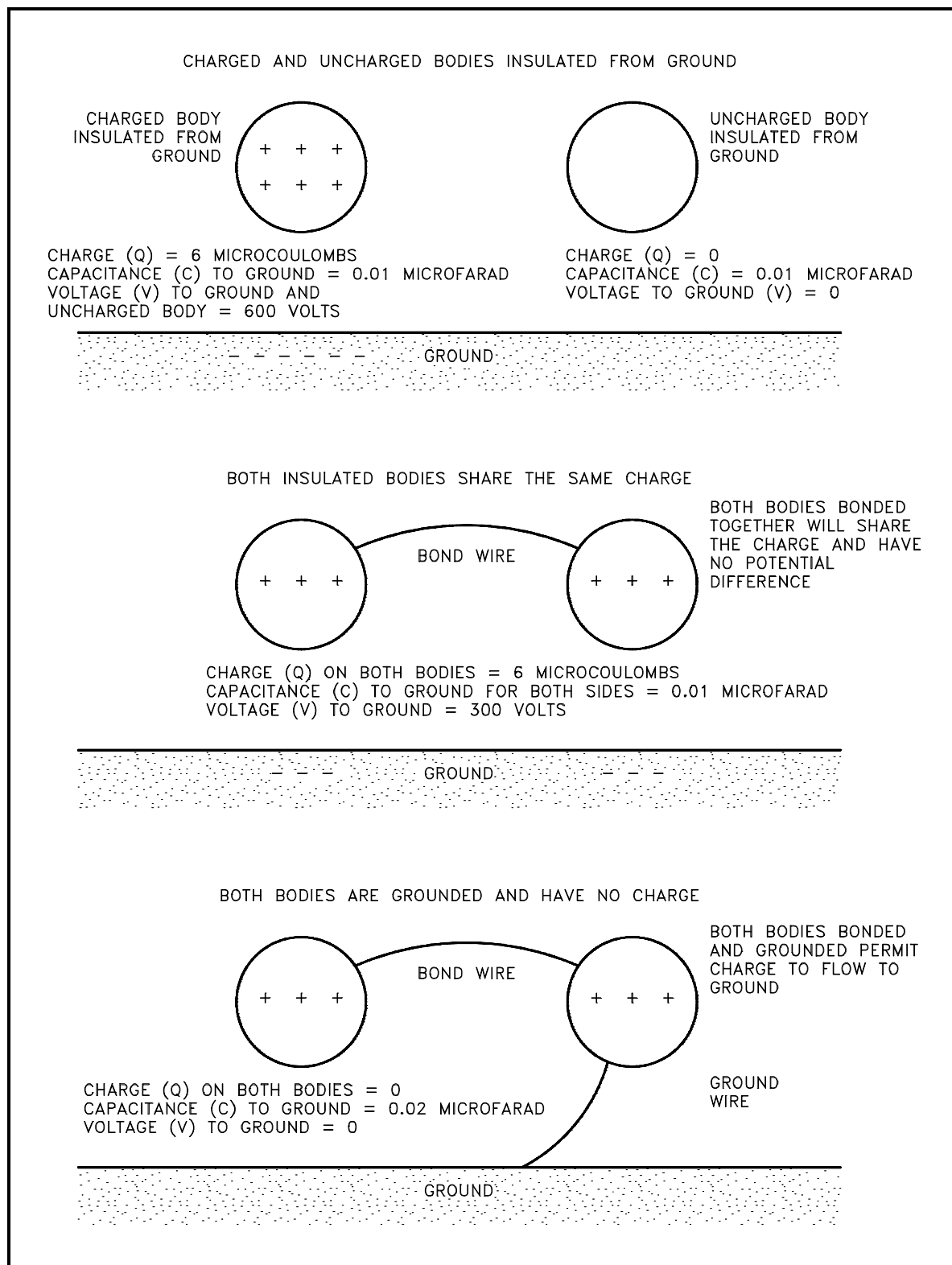

Figure 6 Bonding and Grounding

To avoid a spark from discharge of static electricity during flammable liquid filling operations, a wire bond should be provided between the storage container and the container being filled, unless a metallic path between the container is otherwise present.

Above-ground tanks used for storage of flammable liquids do not have to be grounded unless they are on concrete or on nonconductive supports. Ground wires should be uninsulated so they may be easily inspected for mechanical damage and should never be painted. Figure 7 illustrates grounding above-ground storage tanks.

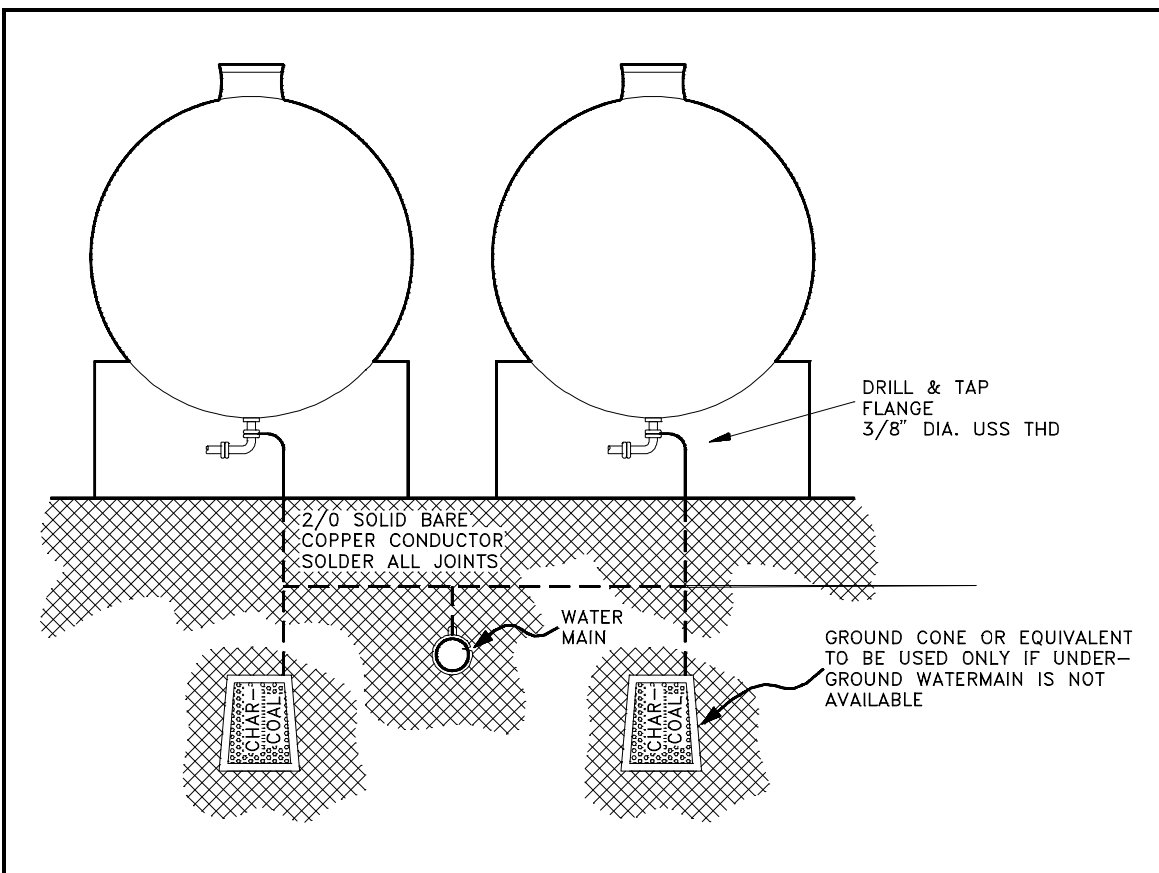

Figure 7 Grounding Above-Ground Storage Tanks

Petroleum liquids are capable of building up electrical charges when they (a) flow through piping, (b) are agitated in a tank or a container, or (c) are subjected to vigorous mechanical movement such as spraying or splashing. Proper bonding or grounding of the transfer system usually dissipates this static charge to ground as it is generated. However, rapid flow rates in transfer lines can cause very high electrical potentials on the surface of liquids regardless of vessel grounding. Also, some petroleum liquids are poor conductors of electricity, particularly the pure, refined products, and even though the transfer system is properly grounded, a static charge may build up on the surface of the liquid in the receiving container. The charge accumulates because static electricity cannot flow through the liquid to the grounded metal container as fast as it is being generated. If this accumulated charge builds up high enough, a static spark with sufficient energy to ignite a flammable air-vapor mixture can occur when the liquid level approaches a grounded probe or when a probe is lowered into a tank for sampling or gaging.

This high static charge is usually controlled by reducing the flow rates, avoiding violent splashing with side-flow fill lines, and using relaxation time, which allows time for the static charge to discharge.

When flammable liquids are transferred from one container to another, a means of bonding should be provided between the two conductive containers prior to pouring, as shown in Figure 8.

In areas where flammable liquids are stored or used, hose nozzles on steam lines used for cleaning should be bonded to the surface of the vessel or object being cleaned. Also, there should be no insulated conductive objects on which the steam could impinge and induce a static charge accumulation.

Nonconductive materials, such as fabric, rubber, or plastic sheeting, passing through or over rolls will also create charges of static electricity. Static from these materials, as well as static from the belts, can be discharged with grounded metal combs or tinsel collectors. Radioactive substances and static neutralizers using electrical discharges are also employed for this purpose.

Bonding and grounding systems should be checked regularly for electrical continuity. Preferably before each fill, the exposed part of the bonding and ground system should be inspected for parts that have deteriorated because of corrosion or that have otherwise been damaged. Many companies specify that bonds and grounds be constructed of bare-braided flexible wire because it facilitates inspection and prevents broken wires from being concealed.

Electricity becomes a source of ignition where flammable vapors exist if the proper type of electrical equipment for these atmospheres either has not been installed or has not been maintained.

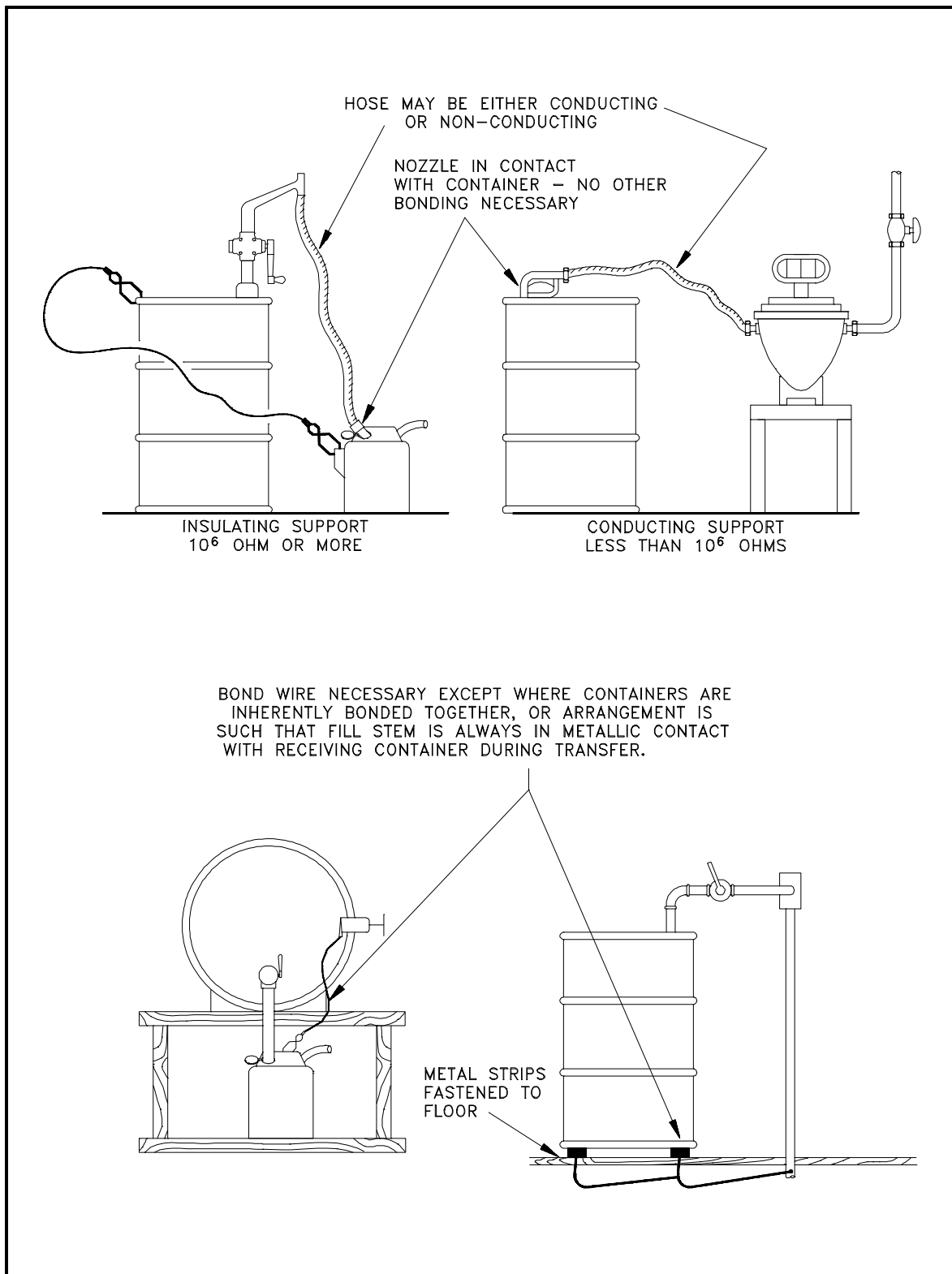

Figure 8 Bonding During Container Filling

A summary of reports of experimental evidence and practical experience in the petroleum industry shows that no significant increase in fire safety is gained by the use of spark-resistant hand tools in the presence of gasoline and similar hydrocarbon vapors. However, some materials such as carbon disulfide, acetylene, and ethyl ether have very low ignition energy requirements. For these and similar materials, the use of special tools designed to minimize the danger of sparks in hazardous locations can be recognized as a conservative safety measure. Leather-faced, plastic, and wood tools are free from the friction-spark hazard, although metallic particles may possibly become embedded in them.

Flammable and combustible liquids and their vapors may create health hazards from both skin contact and inhalation of toxic vapors. Irritation results from the solvent action of many flammable liquids on the natural skin oils and tissue. A toxic hazard of varying degree exists in practically all cases, depending on the concentration of the vapor.

Most vapors from flammable and combustible liquids are heavier than air and will flow into pits, tank openings, confined areas, and low places in which they contaminate the normal air, and cause a toxic as well as explosive atmosphere. Oxygen deficiency occurs in closed containers, such as a tank which has been closed for a long time, and in which rusting has consumed the oxygen. All containers should be aired and tested for toxic and flammable atmosphere as well as the oxygen level before entry.

Storage

Class I and Class II liquids should not be kept or stored in a building except in approved containers, as illustrated in Figure 9, within either a storage cabinet or a storage room that does not have an opening that communicates with the public portion of the building. The spring-loaded cover is designed to open in order to relieve internal vapor pressure. Quantities stored in such locations should be limited. They should not be stored so as to limit use of exits, stairways, or areas normally used for the safe egress of people. Neither should they be stored close to stoves or heated pipes, nor exposed to the rays of the sun or other sources of heat.

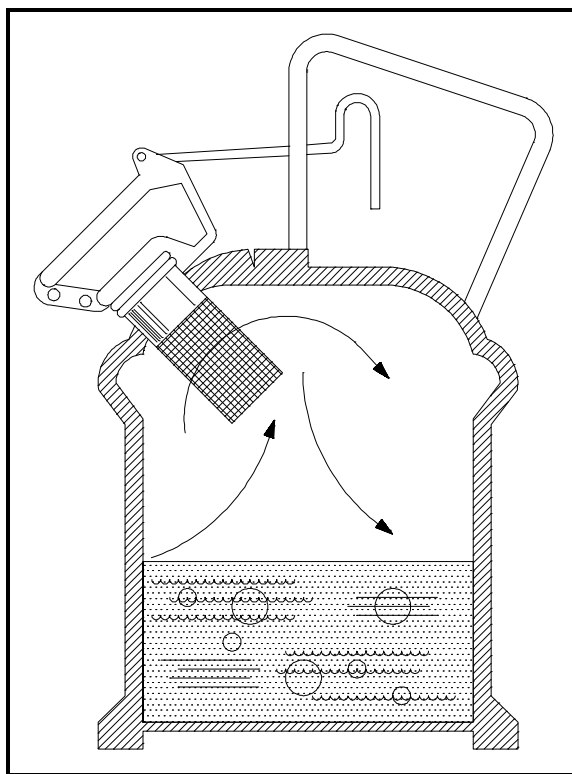

Figure 9 Storage Container With Spring-loaded Cover

Losses by evaporation of liquid stored in safety cans at ordinary temperatures are negligible. Storage of flammable and combustible liquids in open containers should not be permitted. Approved containers for flammable liquids should be closed after each use and when empty. Warning labels should be removed from flammable liquid containers when empty (vapor free). Bulk Class I liquids should be stored in an underground (buried) tank or outside a building. No outlet from the tank should be inside a building unless it terminates in a special room, as illustrated in Figure 10.

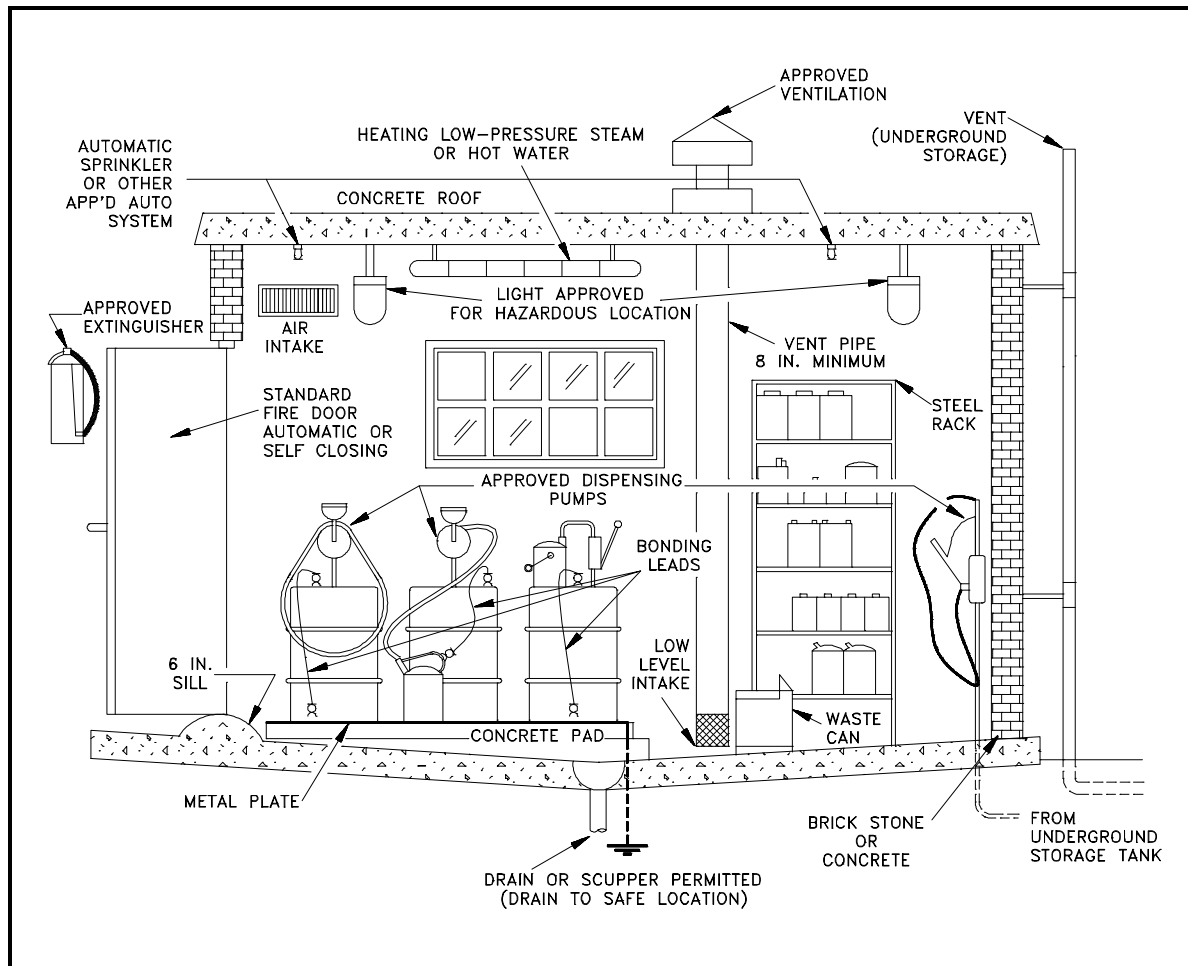

Figure 10 A Flammable Liquids Mixing and Storage Room

Vehicles used on plant property to transport flammable and combustible liquids in sealed containers should be designed to minimize damage to the containers.

When employees are filling tanks and other containers, they should be sure to allow sufficient vapor space (outage) above the liquid level in order to permit expansion of the liquid with changing temperatures. For example, gasoline expands at the rate of about one percent for each

14°F rise in temperature. Outage space for gasoline of two percent of the capacity of the tank or compartment is recommended, and permanent high-level markings should be installed.

Storage tanks should be provided with vents. Vent pipes of underground tanks storing Class I flammable liquids should terminate outside buildings, higher than the fill pipe opening, and not less than 12 feet above the adjacent ground level. They should discharge vertically upward, and be located so that flammable vapors cannot enter building openings or be trapped under eaves or other obstructions. Vent pipes from underground tanks storing Class II or Class III liquids should terminate outside buildings and higher than the fill pipe opening. Vent outlets should be above normal snow level.

Additional information concerning installation, protection, and spacing of storage tanks located above ground, underground, or in areas subject to flooding is beyond the scope of this course. If this information is desired, it may be found in the National Fire Protection Association Standards.

Flammable or combustible liquids in sealed containers represent a potential hazard rather than an active hazard -- the possibility of fire from without. By the same reasoning, inside storage rooms are undesirable. If they must be used, they should be isolated as much as possible, and located at or above ground level. They should not be located over basements and should preferably be along an exterior wall.

Every inside storage room shall be provided with either a gravity (low level intake) or a continuous mechanical exhaust ventilation system. Mechanical ventilation must be used if Class I liquids are contained or dispensed inside the room.

Storage cabinets have specific limits on the amount and class of flammable or combustible liquids that may be stored in them. They must be constructed and sealed so as to be fire resistant. Cabinets shall be labeled conspicuously -- **FLAMMABLE-KEEP FIRE AWAY**.

The most advisable storage facility is a separate building set some distance from normally occupied plant areas. The construction can be similar to that specified for inside storage rooms. The types and classes of flammable and combustible liquids stored will determine the best design to be used.

Summary

The important information from this chapter is summarized below.

Flammable and Combustible Liquids Summary

- The following terms are defined:

Flammable liquid is one having a flash point below 100°F, and having a vapor pressure not exceeding 40 psia at 100°F.

Combustible liquids are liquids with flash points at or above 100°F, but below 200°F.

- General safety precautions regarding the use, handling, and storage of flammable and combustible liquids include the following:

The vapor-air mixture formed from the evaporation of the liquid poses a hazard; therefore, exposures of large liquid surface areas and sources of heat shall be avoided or prevented during handling or storage of these liquids.

Accidental mixture of flammable and combustible liquids shall be avoided.

Fill and discharge lines and openings, as well as control valves associated with flammable and combustible systems, shall be identified by labels, color coding, or both to prevent mixing different substances.

All storage tanks shall be clearly labeled with the name of contents.

Transfer lines from different types and classes of flammable products should be kept separate, and preferably, different pumps should be provided for individual products.

When handling quantities of flammable liquids up to five gallons, a portable FM (Factory Mutual Engineering Corp.) or UL (Underwriters Laboratory) approved container should be used. The container should be clearly labeled.

Smoking, the carrying of strike-anywhere matches, lighters, and other spark-producing devices should not be permitted in a building or area where flammable liquids are stored, handled, or used.

Flammable and Combustible Liquids Summary (Cont.)

- The reasons for and techniques used in bonding and grounding of flammable liquid containers are:

Static electricity is generated by the contact and separation of dissimilar material. The principal hazards created by static electricity are those of fire and explosion, which are caused by spark discharges. A spark between two bodies occurs when there is a poor electrical conductive path between them. Bonding is done to eliminate a difference in potential between objects. Grounding is done to eliminate a difference in potential between an object and ground.

- Four sources of ignition concerning flammable liquids include the following:

All sources of static electricity (induce sparks)

Improper type of electrical equipment for these atmospheres or poorly maintained electrical equipment

Flame-producing operations (smoking, grinding or welding)

Improper hand tools that cause sparks

- The health hazards associated with flammable and/or combustible liquids are:

Fire and explosions

Skin irritation from the solvent action of many flammable liquids

Vapors gather in low points or enclosed areas and cause a toxic environment

end of text.

CONCLUDING MATERIAL

Review activities:

DOE - ANL-W, BNL, EG&G Idaho,
EG&G Mound, EG&G Rocky Flats,
LLNL, LANL, MMES, ORAU, REECo,
WHC, WINCO, WEMCO, and WSRC.

Preparing activity:

DOE - NE-73
Project Number 6910-0021