



DOE-HDBK-1015/1-93  
JANUARY 1993

# DOE FUNDAMENTALS HANDBOOK

## CHEMISTRY

### Volume 1 of 2



**U.S. Department of Energy**  
**Washington, D.C. 20585**

**FSC-6910**

Distribution Statement A. Approved for public release; distribution is unlimited.

This document has been reproduced directly from the best available copy.

Available to DOE and DOE contractors from the Office of Scientific and Technical Information. P.O. Box 62, Oak Ridge, TN 37831; prices available from (615) 576-8401.

Available to the public from the National Technical Information Services, U.S. Department of Commerce, 5285 Port Royal., Springfield, VA 22161.

Order No. DE93011966

---

*DOE-HDBK-1015/1-93*  
*CHEMISTRY*

---

---

---

**ABSTRACT**

---

The *Chemistry Handbook* was developed to assist nuclear facility operating contractors in providing operators, maintenance personnel, and the technical staff with the necessary fundamentals training to ensure a basic understanding of chemistry. The handbook includes information on the atomic structure of matter; chemical bonding; chemical equations; chemical interactions involved with corrosion processes; water chemistry control, including the principles of water treatment; the hazards of chemicals and gases, and basic gaseous diffusion processes. This information will provide personnel with a foundation for understanding the chemical properties of materials and the way these properties can impose limitations on the operation of equipment and systems.

**Key Words:** Training Material, Atomic Structure of Matter, The Periodic Table of the Elements, Chemical Bonding, Corrosion, Water Chemistry Control, Water Treatment Principles, Chemical Hazards, Gaseous Diffusion Processes



---

*DOE-HDBK-1015/1-93*  
*CHEMISTRY*

---

---

## FOREWORD

---

The *Department of Energy (DOE) Fundamentals Handbooks* consist of ten academic subjects, which include Mathematics; Classical Physics; Thermodynamics, Heat Transfer, and Fluid Flow; Instrumentation and Control; Electrical Science; Material Science; Mechanical Science; Chemistry; Engineering Symbolology, Prints, and Drawings; and Nuclear Physics and Reactor Theory. The handbooks are provided as an aid to DOE nuclear facility contractors.

These handbooks were first published as Reactor Operator Fundamentals Manuals in 1985 for use by DOE category A reactors. The subject areas, subject matter content, and level of detail of the Reactor Operator Fundamentals Manuals were determined from several sources. DOE Category A reactor training managers determined which materials should be included, and served as a primary reference in the initial development phase. Training guidelines from the commercial nuclear power industry, results of job and task analyses, and independent input from contractors and operations-oriented personnel were all considered and included to some degree in developing the text material and learning objectives.

The *DOE Fundamentals Handbooks* represent the needs of various DOE nuclear facilities' fundamental training requirements. To increase their applicability to nonreactor nuclear facilities, the Reactor Operator Fundamentals Manual learning objectives were distributed to the Nuclear Facility Training Coordination Program Steering Committee for review and comment. To update their reactor-specific content, DOE Category A reactor training managers also reviewed and commented on the content. On the basis of feedback from these sources, information that applied to two or more DOE nuclear facilities was considered generic and was included. The final draft of each of the handbooks was then reviewed by these two groups. This approach has resulted in revised modular handbooks that contain sufficient detail such that each facility may adjust the content to fit their specific needs.

Each handbook contains an abstract, a foreword, an overview, learning objectives, and text material, and is divided into modules so that content and order may be modified by individual DOE contractors to suit their specific training needs. Each handbook is supported by a separate examination bank with an answer key.

The *DOE Fundamentals Handbooks* have been prepared for the Assistant Secretary for Nuclear Energy, Office of Nuclear Safety Policy and Standards, by the DOE Training Coordination Program. This program is managed by EG&G Idaho, Inc.



---

*DOE-HDBK-1015/1-93*  
*CHEMISTRY*

---

---

## OVERVIEW

---

The *Department of Energy Fundamentals Handbook* entitled *Chemistry* was prepared as an information resource for personnel who are responsible for the operation of the Department's nuclear facilities. An understanding of chemistry will enable contractor personnel to understand the intent of the chemical concerns within their facility. A basic understanding of chemistry is necessary for DOE nuclear facility operators, maintenance personnel, and the technical staff to safely operate and maintain the facility and facility support systems. The information in the handbook is presented to provide a foundation for applying engineering concepts to the job. This knowledge will help personnel understand the impact that their actions may have on the safe and reliable operation of facility components and systems.

The *Chemistry* handbook consists of five modules that are contained in two volumes. The following is a brief description of the information presented in each module of the handbook.

### Volume 1 of 2

#### Module 1 - Fundamentals of Chemistry

Introduces concepts on the atomic structure of matter. Discusses the periodic table and the significance of the information in a periodic table. Explains chemical bonding, the laws of chemistry, and chemical equations.

#### Appendix A - Basic Separation Theory

Introduces basic separation theory for the gaseous diffusion process. Discusses converter construction and basic operating principals.

#### Module 2 - Corrosion

Supplies basic information on the chemical interaction taking place during the corrosion process between the environment and the corroding metal.





---

*DOE-HDBK-1015/1-93*  
*CHEMISTRY*

---

---

---

**OVERVIEW (Cont.)**

---

Volume 2 of 2

Module 3 - Reactor Water Chemistry

Describes the chemical measures taken to retard the corrosion often found in water systems. The consequences of radioactivity on facility cooling water systems are also addressed.

Module 4 - Principles of Water Treatment

Details the principles of ion exchange in the context of water purity. Discusses typical water treatment methods and the basis for these methods.

Module 5 - Hazards of Chemicals and Gases

Explains why certain chemicals are considered hazardous to facility personnel. Includes general safety rules on handling and storage.

The information contained in this handbook is by no means all encompassing. An attempt to present the entire subject of chemistry would be impractical. However, the *Chemistry Handbook* does present enough information to provide the reader with a fundamental knowledge level sufficient to understand the advanced theoretical concepts presented in other subject areas, and to better understand basic system and equipment operation.



**Department of Energy  
Fundamentals Handbook**

**CHEMISTRY  
Module 1  
Fundamentals of Chemistry**



---

**TABLE OF CONTENTS**

---

LIST OF FIGURES . . . . .	iv
LIST OF TABLES . . . . .	v
REFERENCES . . . . .	vi
OBJECTIVES . . . . .	vii
CHARACTERISTICS OF ATOMS . . . . .	1
Characteristics of Matter . . . . .	1
The Atom Structure . . . . .	2
Chemical Elements . . . . .	3
Molecules . . . . .	7
Avogadro's Number . . . . .	8
The Mole . . . . .	9
Mole of Molecules . . . . .	10
Summary . . . . .	11
THE PERIODIC TABLE . . . . .	12
Periodic Table . . . . .	12
Classes of the Periodic Table . . . . .	16
Group Characteristics . . . . .	18
Atomic Structure of Electrons . . . . .	19
Summary . . . . .	22
CHEMICAL BONDING . . . . .	23
Chemical Bonding . . . . .	23
Ionic Bonds . . . . .	24
Covalent Bonds . . . . .	25
Metallic Bonds . . . . .	27
Van der Waals Forces . . . . .	27
Organic Chemistry . . . . .	28
Alkanes . . . . .	28
Alkenes . . . . .	29
Alkynes . . . . .	30

---

**TABLE OF CONTENTS (Cont.)**

---

Aromatics . . . . .	30
Alcohols . . . . .	30
Aldehydes . . . . .	31
Basic Chemical Laws . . . . .	31
Forming Chemical Compounds . . . . .	32
Combining Elements . . . . .	33
Summary . . . . .	34
 CHEMICAL EQUATIONS . . . . .	 36
Le Chatelier's Principle . . . . .	36
Density . . . . .	37
Molarity . . . . .	37
Normality . . . . .	38
Parts per Million . . . . .	39
Chemical Equations . . . . .	40
Balancing Chemical Equations . . . . .	40
Summary . . . . .	45
 ACIDS, BASES, SALTS, AND pH . . . . .	 46
Acids . . . . .	46
Bases . . . . .	47
Salts . . . . .	48
pH . . . . .	48
pOH . . . . .	49
Dissociation Constant . . . . .	50
Summary . . . . .	53
 APPENDIX A BASIC SEPARATION THEORY . . . . .	 A-1
Introduction . . . . .	A-1
Isotopic Separation . . . . .	A-1
Separation Factor . . . . .	A-2
Stage Separation . . . . .	A-2
Barrier Measurements . . . . .	A-5
Cascade Theory . . . . .	A-6
Circuit Balance . . . . .	A-7

---

**TABLE OF CONTENTS (Cont.)**

---

CONVERTERS .....	A-10
Converters .....	A-10
Converter Construction .....	A-10
The Gas Cooler .....	A-12
Barrier Tubing .....	A-12
Process Gas Flow .....	A-12
Diffusion .....	A-13

---

**LIST OF FIGURES**

---

Figure 1 Schematic of a Simple Atom (Helium) . . . . .	2
Figure 2 A Mole of Gold Compared to a Mole of Copper . . . . .	9
Figure 3 Periodic Table of the Elements . . . . .	15
Figure 4 Regional Schematic of Periodic Table . . . . .	16
Figure 5 Electron Shells of Atoms . . . . .	19
Figure 6 Ionic Bond, Sodium Chloride . . . . .	24
Figure 7 Covalent Bond, Methane CH <sub>4</sub> . . . . .	25
Figure 8 Formation of the Carbon Dioxide Molecule . . . . .	26
Figure 9 Coordinate Covalent Bond, Chlorate Ion ClO <sub>3</sub> . . . . .	26
Figure 10 Van der Waals Forces . . . . .	28
Figure 11 Alkane . . . . .	29
Figure 12 Alkene . . . . .	29
Figure 13 Alkyne . . . . .	30
Figure 14 Aromatic . . . . .	30
Figure 15 Alcohol . . . . .	30
Figure 16 Aldehyde . . . . .	31
Figure 17 Ion Product Constant for Water . . . . .	52
Figure A-1 "R" Stage Separation . . . . .	A-3
Figure A-2 Variation of Permeability with the Slope Factor and Change in Pressure . . . .	A-6
Figure A-3 Pressures, Temperatures, and Flows in a Typical V-31 Stage . . . . .	A-8
Figure A-4 Typical Converter . . . . .	A-11



---

## LIST OF TABLES

---

Table 1	Properties of the Atom and its Fundamental Particles . . . . .	3
Table 2	Table of Elements . . . . .	5
Table 3	Description of the Properties of the First Twenty Elements . . . . .	12
Table 4	Electrons, Orbital, and Shell Relationships in Atomic Structure . . . . .	20
Table 5	Ion Product Constant and Neutral pH for Water at Various Temperatures . . . . .	51
Table A-1	Converter Stage Size vs. Location . . . . .	A-10

---

**REFERENCES**

---

- Donald H. Andrews and Richard J. Kokes, Fundamental Chemistry, John Wiley & Sons, Inc., 1963
- Compressed Gas Association, Inc., Handbook of Compressed Gases, 2nd Edition, Reinhold Publishing Corporation, 1981.
- R. A. Day, Jr. and R. C. Johnson, General Chemistry, Prentice Hall, Inc., 1974.
- Dickerson, Gray, Darensbourg and Darensbourg, Chemical Principles, 4th Edition, The Benjamin Cummings Publishing Company, 1984.
- Academic Program for Nuclear Plant Personnel, Volume II, Chemistry, Columbia, MD, General Physics Corporation, Library of Congress Card #A 326517, 1972.
- General Physics Corporation, Fundamentals of Chemistry, General Physics Corporation, 1982.
- Glasstone and Sesonske, Nuclear Reactor Engineering, 3rd Edition, Van Nostrand Reinhold Company, 1981.
- McElroy, Accident Prevention Manual for Industrial Operations Engineering and Technology, Volume 2, 8th Edition, National Safety Council, 1980.
- Sienko and Plane, Chemical Principles and Properties, 2nd Edition, McGraw and Hill, 1974.
- Underwood, Chemistry for Colleges and Schools, 2nd Edition, Edward Arnold, Ltd., 1967.
- Norman V. Steere and Associates, CRC Handbook of Laboratory Safety, 2nd Edition, CRC Press, Inc., 1971.

---

## TERMINAL OBJECTIVE

---

- 1.0 Without references, **DESCRIBE** the characteristics of an atom.

---

## ENABLING OBJECTIVES

---

- 1.1 **DEFINE** the following terms:
- |    |                  |    |                       |
|----|------------------|----|-----------------------|
| a. | States of matter | d. | Mole                  |
| b. | Atomic weight    | e. | Gram atomic weight    |
| c. | Molecular weight | f. | Gram molecular weight |
- 1.2 **LIST** the components of an atom, their relative sizes, and charges.
- 1.3 **STATE** the criterion used to classify an atom chemically.
- 1.4 **DEFINE** the following subdivisions of the periodic table:
- |    |                               |
|----|-------------------------------|
| a. | Periods of the periodic table |
| b. | Groups of the periodic table  |
| c. | Classes of the periodic table |
- 1.5 Given a periodic table, **IDENTIFY** the following subdivisions:
- |    |                               |
|----|-------------------------------|
| a. | Periods of the periodic table |
| b. | Groups of the periodic table  |
| c. | Classes of the periodic table |
- 1.6 **LIST** the characteristics that elements in the same group on the periodic table share.
- 1.7 **DEFINE** the term valence.

---

## TERMINAL OBJECTIVE

---

- 2.0 Given an incomplete chemical equation, **BALANCE** the equation by the method presented.

---

## ENABLING OBJECTIVES

---

- 2.1 **DEFINE** the following terms:

- |                         |                   |
|-------------------------|-------------------|
| a. Ionic bonds          | c. Covalent bonds |
| b. Van der Waals forces | d. Metallic bonds |

- 2.2 **DESCRIBE** the physical arrangement and bonding of a polar molecule.

- 2.3 **DESCRIBE** the three basic laws of chemical reactions.

- 2.4 **STATE** how elements combine to form chemical compounds.

- 2.5 **EXPLAIN** the probability of any two elements combining to form a compound.

- 2.6 **DEFINE** the following terms:

- |            |               |                |
|------------|---------------|----------------|
| a. Mixture | c. Solubility | e. Solution    |
| b. Solvent | d. Solute     | f. Equilibrium |

- 2.7 **STATE** Le Chatelier's principle.

- 2.8 **DEFINE** the following terms:

- |             |              |
|-------------|--------------|
| a. ppm      | c. Density   |
| b. Molarity | d. Normality |

- 2.9 **BALANCE** chemical equations that combine elements and/or compounds.

---

## TERMINAL OBJECTIVE

---

- 3.0 Given sufficient information about a solution, **CALCULATE** the pH and pOH of the solution.

---

## ENABLING OBJECTIVES

---

- 3.1 **DEFINE** the following terms:

- |    |          |    |                                |
|----|----------|----|--------------------------------|
| a. | Acid     | e. | Base                           |
| b. | Salt     | f. | pH                             |
| c. | pOH      | g. | Dissociation constant of water |
| d. | Alkalies |    |                                |

- 3.2 **STATE** the formula for pH.

- 3.3 **STATE** the formula for pOH.

- 3.4 **CALCULATE** the pH of a specified solution.

Intentionally Left Blank

---

## CHARACTERISTICS OF ATOMS

---

*Chemistry is defined as the systematic investigation of the properties, structure, and behavior of matter and the changes matter undergoes. This general definition raises many questions. These questions are answered in the study of chemistry. Terms and basic concepts that help in understanding chemistry will be discussed in this chapter.*

**EO 1.1      DEFINE the following terms:**

- |           |                         |           |                              |
|-----------|-------------------------|-----------|------------------------------|
| <b>a.</b> | <b>States of matter</b> | <b>d.</b> | <b>Mole</b>                  |
| <b>b.</b> | <b>Atomic weight</b>    | <b>e.</b> | <b>Gram atomic weight</b>    |
| <b>c.</b> | <b>Molecular weight</b> | <b>f.</b> | <b>Gram molecular weight</b> |

**EO 1.2      LIST the components of an atom, their relative sizes, and charges.**

**EO 1.3      STATE the criterion used to classify an atom chemically.**

---

### Characteristics of Matter

The term *states of matter* refers to the physical forms in which matter exists: solid, liquid, and gas. Solids are characterized as having both a definite shape and a definite volume. In a solid, the forces that keep the molecules or atoms together are strong. Therefore, a solid does not require outside support to maintain its shape.

Liquids have definite volumes but indefinite shapes and are slightly compressible. Liquids take the shape of their containers. The forces that keep a liquid's molecules or atoms together are weaker than in the solids.

Gases are readily compressible and capable of infinite expansion. They have indefinite shape and indefinite volume. Of the three states, gases have the weakest forces holding their molecules or atoms together.

The different states of matter have one thing in common; they can all be broken down into fundamental units called atoms.

## **The Atom Structure**

All matter is composed of atoms, existing individually or in combination with each other. An atom is an extremely small electrically-neutral particle. It is the smallest unit involved in the chemical change of matter. Atoms can be treated as distinct particles because they behave as such chemically, but atoms themselves are composed of even smaller subparts. Understanding these atomic subparticles is important in understanding chemistry.

An atom is composed of a positively-charged nucleus orbited by one or more negatively-charged particles called electrons. A simplified schematic representation of this arrangement is illustrated in Figure 1. The nucleus is the core of an atom. It has a positive charge because it usually consists of two particles, the neutron and the proton (hydrogen is the exception with only a proton in the nucleus). The neutrons are electrically neutral, and the protons are electrically positive. A nucleus with one proton has a charge of +1 (or simply 1), and a nucleus with two protons has a +2 charge. Together the neutrons and protons give the nucleus its mass, but the proton alone gives the nucleus its positive charge.

Neutrons and protons are relatively massive and are essentially equal in mass.

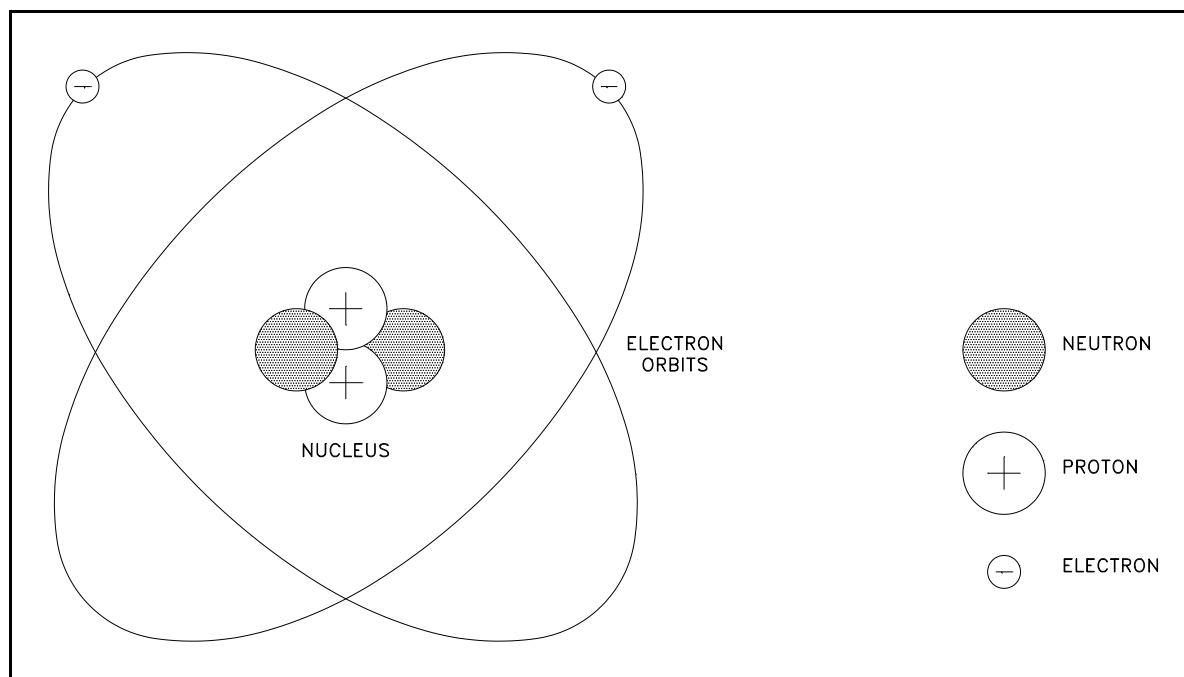

Figure 1 Schematic of a Simple Atom (Helium)



The particles that orbit the nucleus are electrons. They are very small, with a mass only 1/1835 the mass of a proton or neutron. Each electron is negatively charged, and the charge of one electron is equal in magnitude (but opposite in sign) to the charge of one proton. The number of electrons orbiting a nucleus is exactly equal to the number of protons contained in that nucleus. The equal and opposite charges cancel each other, and the atom as a whole is neutral. The electrons are bound in the atom by electrostatic attraction. The atom remains neutral unless some external force causes a change in the number of electrons.

The diameter of the atom is determined by the range of the electrons in their travels around the nucleus and is approximately  $10^{-8}$  cm. The diameter of the nucleus is roughly 10,000 times smaller, approximately  $10^{-13}$  to  $10^{-12}$  cm. Because the nucleus is composed of neutrons and protons that are about 1835 times heavier than an electron, the nucleus contains practically all the mass of the atom, but constitutes a very small fraction of the volume. Although electrons are individually very small, the space in which they orbit the nucleus constitutes the largest part of the atomic volume.

Figure 1 illustrates these size relationships, but not to scale. If the nucleus were the size shown, the electrons would be several hundred feet away.

Some of the properties of the atom and its component parts are summarized in Table 1. The masses listed in Table 1 are measured in atomic mass units (amu), which is a relative scale in which the mass of a proton is about 1.0.

<b>TABLE 1</b>		
<b>Properties of the Atom and its Fundamental Particles</b>		
Particle Name	Relative Mass (amu)	Relative Charge (based on charge of proton)
Electron	0.00055 or 1/1835	-1
Proton	1.0	1
Neutron	1.0	0

## **Chemical Elements**

An atom is classified chemically by the number of protons in its nucleus. Atoms that have the same number of protons in their nuclei have the same chemical behavior. Atoms that have the same number of protons are grouped together and constitute a chemical element.

## **Chemical Symbols**

At one time chemists used various symbols, similar to shorthand, for the atoms of the different elements. These symbols were very cumbersome and were replaced by abbreviations of the names of the elements. Each element has been assigned a specific one or two letter symbol based on the first letter of its chemical name. Because there are several elements with the same first letter, it is often necessary to add the second letter to the symbol. In some cases the symbol comes from an abbreviation for the old latin name of the element. For example, Fe stands for iron (ferrum) and Cu for copper (cuprum). The first letter of the chemical symbol is always capitalized. If the symbol has two letters, the second letter is always lowercase.

## **Atomic Number**

The number of protons in the nucleus plays such an important role in identifying the atom that it is given a special name, the *atomic number*. The symbol  $Z$  is often used for atomic number (or number of protons). Hydrogen has an atomic number of 1 and lawrencium has an atomic number of 103. The atomic number is also equal to the number of electrons.

## **Atomic Mass Number**

The sum of the total number of protons,  $Z$ , and the total number of neutrons,  $N$ , is called the *atomic mass number*. The symbol is  $A$ . Not all atoms of the same element have the same atomic mass number, because, although the  $Z$  is the same, the  $N$  and thus the  $A$  are different. Atoms of the same element with different atomic mass numbers are called *isotopes*.

## **Atomic Weight**

In Table 1, the masses of atomic particles are given in atomic mass units (amu). These units represent a relative scale in which the mass of the isotope carbon-12 is used as the standard and all others are related to it. Specifically, 1 amu is defined as 1/12 the mass of the carbon-12 atom. Since the mass of a proton or a neutron is approximately 1 amu, the mass of a particular atom will be approximately equal to its atomic mass number,  $Z$ .

The atomic weight of an element is generally more useful than isotopic masses. The *atomic weight* of an element is defined as the weighted average of the masses of all of its natural occurring isotopes. The atomic weight of the elements are listed in Table 2. The elements that have their atomic weights in parentheses are unstable. For these elements, the atomic weight of the longest living isotope is used rather than the average of the masses of all occurring isotopes.

**TABLE 2**  
**Table of Elements**

Name and Symbol	Atomic Number	Atomic Weight (amu)	Name	Atomic Number	Atomic Weight (amu)
Actinium Ac	89	(227)	Curium Cm	96	(247)
Aluminum Al	13	26.981	Dysprosium Dy	66	162.50
Americium Am	95	(243)	Einsteinium Es	99	(252)
Antimony Sb	51	121.75	Erbium Er	68	167.26
Argon Ar	18	39.948	Europium Eu	63	151.96
Arsenic As	33	74.921	Fermium Fm	100	(257)
Astatine At	85	(210)	Fluorine F	9	18.998
Barium Ba	56	137.34	Francium Fr	87	(223)
Berkelium Bk	97	(247)	Gadolinium Gd	64	157.25
Beryllium Be	4	9.012	Gallium Ga	31	69.72
Bismuth Bi	83	208.980	Germanium Ge	32	72.59
Boron B	5	10.811	Gold Au	79	196.967
Bromine Br	35	79.909	Hafnium Hf	72	178.49
Cadmium Cd	48	112.40	Helium He	2	4.0026
Calcium Ca	20	40.08	Holmium Ho	67	164.930
Californium Cf	98	(251)	Hydrogen H	1	1.0079
Carbon C	6	12.011	Indium In	49	114.82
Cerium Ce	58	140.12	Iodine I	53	126.904
Cesium Cs	55	132.905	Iridium Ir	77	192.2
Chlorine Cl	17	35.453	Iron Fe	26	55.874
Chromium Cr	24	51.996	Krypton Kr	36	83.80
Cobalt Co	27	58.933	Lanthanum La	57	138.91
Copper Cu	29	63.546	Lawrencium Lw	103	(260)

**TABLE 2 (Cont.)**  
**Table of Elements**

Name and Symbol		Atomic Number	Atomic Weight (amu)	Name		Atomic Number	Atomic Weight (amu)
Lead	Pb	82	207.19	Potassium	K	19	39.102
Lithium	Li	3	6.939	Praseodymium	Pr	59	140.90
Lutetium	Lu	71	174.97	Protactinium	Pa	91	231.03
Magnesium	Mg	12	24.312	Promethium	Pm	61	(145)
Manganese	Mn	25	54.938	Radium	Ra	88	226.02
Mendelevium	Md	101	(258)	Radon	Rn	86	(222)
Mercury	Hg	80	200.59	Rhenium	Re	75	186.2
Molybdenum	Mo	42	95.94	Rhodium	Rh	45	102.90
Neodymium	Nd	60	144.24	Rubidium	Rb	37	85.47
Neon	Ne	10	20.183	Ruthenium	Ru	44	101.07
Neptunium	Np	93	237.05	Samarium	Sm	62	150.35
Nickel	Ni	28	58.71	Scandium	Sc	21	44.956
Niobium	Nb	41	92.906	Selenium	Se	34	78.96
Nitrogen	N	7	14.006	Silicon	Si	34	78.96
Nobelium	No	102	(259)	Silver	Ag	47	107.87
Osmium	Os	76	190.2	Sodium	Na	11	22.989
Oxygen	O	8	15.999	Strontium	Sr	38	87.62
Palladium	Pd	46	106.41	Sulfur	S	16	32.064
Phosphorus	P	15	30.973	Tantalum	Ta	73	180.94
Platinum	Pt	78	195.09	Technetium	Tc	43	(98)
Plutonium	Pu	94	(244)	Tellurium	Te	52	127.60
Polonium	Po	84	(209)	Terbium	Tb	65	158.92

**TABLE 2 (Cont.)**  
**Table of Elements**

Name and Symbol		Atomic Number	Atomic Weight (amu)	Name		Atomic Number	Atomic Weight (amu)
Thallium	Tl	81	204.37	Vanadium	V	23	50.942
Thorium	Th	90	232.03	Xenon	Xe	54	131.30
Thulium	Tm	69	168.93	Ytterbium	Yb	70	173.04
Tin	Sn	50	118.69	Yttrium	Y	39	88.905
Titanium	Ti	22	47.90	Zinc	Zn	30	65.37
Tungsten	W	74	183.85	Zirconium	Zr	40	91.22
Uranium	U	92	238.03				

## Molecules

*Molecules* are groups or clusters of atoms held together by means of chemical bonding. There are two types of molecule; molecules of an element and molecules of a compound.

### Molecules of an Element

In certain cases, two single atoms of an element can be attracted to one another by a bond to form a molecule. Examples of this are hydrogen, oxygen, and bromine. The molecular formulas for these are  $H_2$ ,  $O_2$ , and  $Br_2$ . Most gaseous elements exist as molecules of two atoms.

### Molecules of a Compound

Two atoms of different elements held together by a bond form a compound. The molecule is the primary particle of a chemical compound. Some examples of this type of molecule include hydrogen chloride ( $HCl$ ), water ( $H_2O$ ), methane ( $CH_4$ ), and ammonia ( $NH_3$ ).

### Molecular Weight

The weight of a molecule, the *molecular weight*, is the total mass of the individual atoms. Therefore, it is fairly simple to calculate the mass of any molecule if its formula is known (that is, the elements and the number of each that make up the molecule). Note that the terms mass and weight are used interchangeably in chemistry.

Example 1:

The compound water has a formula of  $\text{H}_2\text{O}$ . This means there is one atom of oxygen and two atoms of hydrogen. Calculate the molecular weight.

Solution:

The molecular weight is calculated as follows:

$$\begin{aligned} 1 \text{ atom} &\times 16.000 \text{ (the atomic weight of oxygen)} = 16.000 \text{ amu} \\ \underline{2 \text{ atoms} &\times 1.008 \text{ (the atomic weight of hydrogen)} = 2.016 \text{ amu}} \\ \text{molecular weight of water} &= 18.016 \text{ amu} \end{aligned}$$

Example 2:

Calculate the molecular weight of  $\text{H}_2\text{SO}_4$ .

Solution:

$$\begin{aligned} \text{hydrogen} & 2 \text{ atoms} \times 1.008 \text{ amu} = 2.016 \text{ amu} \\ \text{sulfur} & 1 \text{ atom} \times 32.064 \text{ amu} = 32.064 \text{ amu} \\ \underline{\text{oxygen} & 4 \text{ atoms} \times 15.999 \text{ amu} = 63.996 \text{ amu}} \\ \text{molecular weight} &= 98.076 \text{ amu} \end{aligned}$$

Example 3:

Calculate the molecular weight of HCl.

Solution:

$$\begin{aligned} \text{hydrogen} & 1 \text{ atom} \times 1.008 \text{ amu} = 1.008 \text{ amu} \\ \underline{\text{chlorine} & 1 \text{ atom} \times 35.453 \text{ amu} = 35.453 \text{ amu}} \\ \text{molecular weight} &= 36.461 \text{ amu} \end{aligned}$$

## Avogadro's Number

Consider one atom of oxygen and one atom of sulfur, and compare their atomic weights.

Oxygen's atomic weight = 15.999 amu

Sulfur's atomic weight = 32.06 amu

The sulfur atom weighs approximately twice as much as the oxygen atom.  
( $32.06 \div 15.99 \approx 2$ )

Because the sulfur atom weighs twice as much as an oxygen atom, a one gram sample of oxygen contains twice as many atoms as a one gram sample of sulfur. Thus, a two gram sample of sulfur contains the same number of atoms as a one gram sample of oxygen.

From this previous example, one might suggest that a relationship exists between the weight of a sample and the number of atoms in the sample. In fact, scientists have determined that there is a definite relationship between the number of atoms in a sample and the sample's weight. Experimentation has shown that, for any element, a sample containing the atomic weight in grams contains  $6.022 \times 10^{23}$  atoms. Thus 15.999 grams of oxygen contains  $6.022 \times 10^{23}$  atoms, and 32.06 grams of sulfur contains  $6.022 \times 10^{23}$  atoms. This number ( $6.022 \times 10^{23}$ ) is known as *Avogadro's number*. The importance of Avogadro's number to chemistry should be clear. It represents the number of atoms in X grams of any element, where X is the atomic weight of the element. It permits chemists to predict and use exact amounts of elements needed to cause desired chemical reactions to occur.

## The Mole

A single atom or a few atoms are rarely encountered. Instead, larger, macroscopic quantities are used to quantify or measure collections of atoms or molecules, such as a glass of water, a gallon of alcohol, or two aspirin. Chemists have introduced a large unit of matter, the mole, to deal with macroscopic samples of matter.

One mole represents a definite number of objects, substances, or particles. (For example, a mole of atoms, a mole of ions, a mole of molecules, and even, theoretically, a mole of elephants.) A *mole* is defined as the quantity of a pure substance that contains  $6.022 \times 10^{23}$  units (atoms, ions, molecules, or elephants) of that substance. In other words, a mole is Avogadro's number of anything.

For any element, the mass of a mole of that element's atoms is the atomic mass expressed in units of grams. For example, to calculate the mass of a mole of copper atoms, simply express the atomic mass of copper in units of grams. Because the atomic mass of copper is 63.546 amu, a mole of copper has a mass of 63.546 grams. The value for the atomic mass of gold is 196.967 amu. Therefore, a mole of gold has a mass of 196.967 grams. The mass of a mole of atoms is called the *gram atomic weight* (GAW). The mole concept allows the conversion of grams of a substance to moles and vice versa.

Figure 2 contains a ball of gold and a ball of copper. The two balls are of different masses and different sizes, but each contains an identical number of atoms.

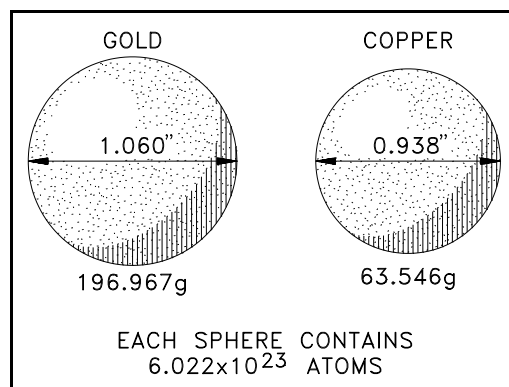

Figure 2 A Mole of Gold Compared to a Mole of Copper

Example 1:

A silver bar has a mass of 1870 grams. How many moles of silver are in the bar?

Solution:

Since the atomic mass of silver (Ag) is 107.87 amu, one mole of silver has a mass of 107.87 grams. Therefore, there is one mole of Ag per 107.87 grams of Ag or  $\frac{1 \text{ mole Ag}}{107.87 \text{ grams Ag}}$ . There are 1870 grams of silver.

$$\frac{1870 \text{ grams Ag}}{1} \times \frac{1 \text{ mole Ag}}{107.87 \text{ grams Ag}} = 17.3 \text{ mole Ag}$$

Example 2:

Mercury (Hg) is the only metal that exists as a liquid at room temperature. It is used in thermometers. A thermometer contains 0.004 moles of mercury. How many grams of mercury are in the thermometer?

Solution:

Since the atomic mass of Hg is 201 amu, one mole of Hg has a mass of 201 grams of Hg or  $\frac{201 \text{ grams Hg}}{1 \text{ mole Hg}}$ . There are 0.004 moles of Hg.

$$\frac{0.004 \text{ moles Hg}}{1} \times \frac{201 \text{ grams Hg}}{1 \text{ mole Hg}} = 0.8 \text{ grams Hg}$$

## Mole of Molecules

The mass of a mole of molecules of a substance is the molecular mass expressed in grams. For example, an oxygen molecule (O<sub>2</sub>) has a molecular mass equivalent to 32.0 grams because each oxygen atom has a molecular mass of 16.0 grams. (Recall that to obtain the molecular mass, the atomic masses of all atoms that appear in the formula are added.) If the atomic masses of the carbon and four hydrogen atoms in methane, CH<sub>4</sub>, are added, the total is 16 amu. Therefore, one mole of CH<sub>4</sub> has a mass of 16 grams. The mass of a mole of molecules is called the molar mass or *gram molecular weight* (GMW).



## **Summary**

The important information found in this chapter is summarized below.

### **Characteristics of Atoms Summary**

- The following terms are defined:

States of matter is a term which refers to the physical forms in which matter exists; solid, liquid and gas. Solids are characterized as having both a definite shape and a definite volume. Liquids have definite volumes but indefinite shapes and are slightly compressible. Gases are readily compressible and capable of infinite expansion.

Atomic weight is defined as the weighted average of the masses of all its natural occurring isotopes.

Molecular weight will be the total weight of the individual atoms of a molecule.

A mole is Avogadro's number of any substance.

Gram atomic weight is the mass of a mole of atoms.

Gram molecular weight is the mass of a mole of molecules, (GMW).

- The components of an atom are protons, neutrons, and electrons. A proton has a mass of 1.0 amu and a positive charge (+1). The neutron also has a mass of 1.0 amu but is neutral in charge. The electron has a mass of .00055 or 1/1835 amu and a negative charge (-1).
- An atom is classified chemically by the number of protons in its nucleus.

## THE PERIODIC TABLE

*All known elements fall into a pattern when placed in a periodic table, and the position in this pattern is decided by the element's atomic number. This chapter will discuss the significance of this fact.*

**EO 1.4      DEFINE the following subdivisions of the periodic table:**

- a.      **Periods of the periodic table**
- b.      **Groups of the periodic table**
- c.      **Classes of the periodic table**

**EO 1.5      Given a periodic table, IDENTIFY the following subdivisions:**

- a.      **Periods of the periodic table**
- b.      **Groups of the periodic table**
- c.      **Classes of the periodic table**

**EO 1.6      LIST the characteristics that elements in the same group on the periodic table share.**

**EO 1.7      DEFINE the term valence.**

### Periodic Table

Over many years of chemical investigation, scientists have discovered a remarkable feature of the elements. If the elements are arranged in the order of their atomic numbers, the chemical properties of the elements are repeated somewhat regularly. To a lesser extent, the physical properties are also repeated periodically. This periodic repetition can be seen in Table 3. Compare the properties of lithium (Li), sodium (Na), and potassium (K), and also those of beryllium (Be), magnesium (Mg), and calcium (Ca). In the list of elements shown in Table 3 the properties are repeated every eighth element.

<b>TABLE 3</b>				
<b>Description of the Properties of the First Twenty Elements</b>				
Element	Symbol	Atomic Number	Atomic Weight	Description of Properties
Hydrogen	H	1	1.008	Colorless gas, reacts readily with oxygen to form H <sub>2</sub> O; forms HCl with chlorine.
Helium	He	2	4.003	Colorless gas, very non-reactive chemically.

**TABLE 3 (Cont.)**  
**Description of the Properties of the First Twenty Elements**

Lithium	Li	3	6.939	Silvery white, soft metal, very reactive chemically, forms $\text{Li}_2\text{O}$ and $\text{LiCl}$ readily.
Beryllium	Be	4	9.012	Grey metal, much harder than lithium, fairly reactive chemically, forms $\text{BeO}$ and $\text{BeCl}_2$ easily.
Boron	B	5	10.811	Yellow or brown non-metal, very hard element, not very reactive, but will form $\text{B}_2\text{O}_3$ , and $\text{BCl}_3$ .
Carbon	C	6	12.011	Black non-metal, brittle, non-reactive at room temperature. Forms $\text{CO}_2$ and $\text{CCl}_4$ .
Nitrogen	N	7	14.007	Colorless gas, not very reactive, will form $\text{N}_2\text{O}_5$ and $\text{NH}_3$ .
Oxygen	O	8	15.999	Colorless gas, moderately reactive, will combine with most elements, forms $\text{CO}_2$ , $\text{MgO}$ , etc.
Fluorine	F	9	18.998	Green-yellow gas, extremely reactive, irritating to smell, forms $\text{NaF}$ , $\text{MgF}_2$ .
Neon	Ne	10	20.183	Colorless gas, very non-reactive chemically.
Sodium	Na	11	22.990	Silvery soft metal, very reactive chemically, forms $\text{Na}_2\text{O}$ and $\text{NaCl}$ .
Magnesium	Mg	12	24.312	Silvery white metal, much harder than sodium. Fairly reactive, forms $\text{MgO}$ and $\text{MgCl}_2$ .
Aluminum	Al	13	26.982	Silvery white metal, like magnesium but not as reactive. Forms $\text{Al}_2\text{O}_3$ and $\text{AlCl}_3$ .
Silicon	Si	14	28.086	Gray, non-metallic, non-reactive at room temperature, forms $\text{SiO}_2$ and $\text{SiCl}_4$ .
Phosphorus	P	15	30.974	Black, red, violet, or yellow solid, low melting point, quite reactive, forms $\text{P}_2\text{O}_5$ and $\text{PCl}_3$ .
Sulfur	S	16	32.064	Yellow solid with low melting point. Moderately reactive, combines with most elements, forms $\text{SO}_2$ , $\text{MgS}$ , etc.
Chlorine	Cl	17	35.453	Greenish-yellow gas, extremely reactive, irritating to smell, forms $\text{NaCl}$ , $\text{MgCl}_2$ .
Argon	Ar	18	39.948	Colorless gas, very non-reactive chemically.
Potassium	K	19	39.102	Silver soft metal, very reactive chemically, forms $\text{K}_2\text{O}$ and $\text{KCl}$ .
Calcium	Ca	20	40.080	Silver-white metal, much harder than potassium, fairly reactive, forms $\text{CaO}$ and $\text{CaCl}_2$ .

A table in which elements with similar chemical properties are grouped together is called a periodic table. One of the most common versions is shown in Figure 3. In this table, elements are arranged in order of increasing atomic number in succeeding rows. Each horizontal row is called a *period*. Note that some periods are longer than others. Elements with similar chemical properties appear in vertical columns called *groups*. Each group is designated by a Roman numeral and a capital letter, except the one on the extreme right-hand side, Group 0 (the inert gases). At the bottom of the periodic table are two long rows of elements identified as the lanthanide series and the actinide series. They are separated from the table primarily to keep it from becoming too wide. Also, the elements within each of these two series show similar chemical properties.

The number directly below each element is its atomic number, and the number above each element is its atomic weight. In several cases the atomic weights are in parentheses. This indicates that these elements have no stable isotopes; that is, they are radioactive. The value enclosed in parentheses and used for the atomic weight is the atomic mass number of the most stable known isotope, as indicated by the longest half-life.



## Classes of the Periodic Table

There are three broad *classes* of elements. These are the metals, the non-metals, and the semi-metals. These three classes are grouped together on the periodic table as shown on Figure 4.

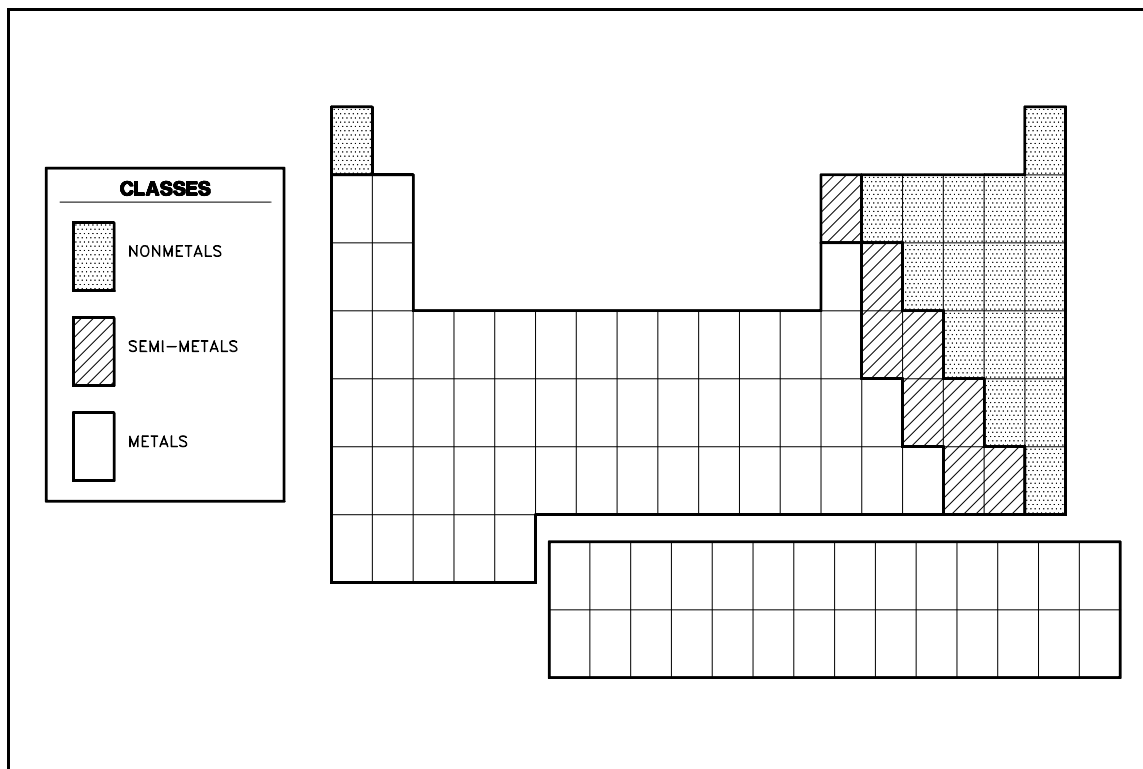

Figure 4 Regional Schematic of Periodic Table

## Metals

The metals constitute the largest class of elements and are located on the left and toward the center of the periodic table as shown in Figure 4. In Figure 3, the heavy line running step-wise from boron (B) to astatine (At) generally separates the metals from the rest of the elements (elements in the actinide and lanthanide series are metals). Metals tend to lose electrons to form positive ions rather than to gain electrons and become negative ions.

Most people are familiar with metals' physical properties. They are usually hard and strong, capable of being shaped mechanically (malleable and ductile), and good conductors of heat and electricity, and they have lustrous surfaces when clean. More important for chemical classification are the chemical properties of metals because the physical properties are not common to all metals. For example, mercury (Hg) is a metal, although it is a liquid at room temperature, and sodium is a metal although it is not at all hard or strong. Metals can be involved in a wide range of chemical reactions. Their reactions with water range from violent with sodium and potassium to imperceptible with gold and platinum. Metals are divided into the following two categories.

1. The light metals, which are soft, have a low density, are very reactive chemically, and are unsatisfactory as structural materials.
2. The transition metals, which are hard, have a high density, do not react readily, and are useful structural materials.

The metals in Category 1 are located at the far left of the table (Groups IA and IIA). The metals in Category 2 are located in the middle of the table (the B groups).

### **Nonmetals**

The nonmetals occupy the part of the periodic table to the right of the heavy, step-like line. (refer to Figure 3 and Figure 4)

In general, the physical properties of the nonmetals are the opposite of those attributed to metals. Nonmetals are often gases at room temperature. The nonmetals that are solids are not lustrous, are not malleable or ductile, and are poor conductors of heat and electricity. Some nonmetals are very reactive, but the nature of the reactions is different from that of metals. Nonmetals tend to gain electrons to form negative ions rather than to lose electrons to form positive ions.

The six elements in Group 0 represent a special subclass of nonmetals. They are all very unreactive gases, so they are called the inert gases. For many years it was believed that the inert gases would not and could not participate in chemical reactions. In 1962, the first true compounds of an inert gas, XeF<sub>4</sub> and XePtF<sub>6</sub>, were positively identified.

Since that time, several other compounds have been prepared. The preparation of these compounds requires special conditions; under ordinary conditions, the inert gases may be considered nonreactive.

### **Semi-Metals**

The obvious trend in the periodic table is that from left to right, across any period, the elements change from distinctly metallic (Group IA) to distinctly nonmetallic (Group VIIA). This change in character is not sharply defined, but is gradual. Generally, elements well to the left of the heavy diagonal line are metals, and those well to the right are nonmetals. Some of the elements near the line, however, exhibit properties of metals under some conditions and properties of nonmetals under other conditions. These elements are called the semi-metals and include boron (B), silicon (Si), germanium (Ge), arsenic (As), and tellurium (Te). They are usually classified as semi-conductors of electricity and are widely used in electrical components.

## **Group Characteristics**

Each set of elements appearing in the vertical column of a periodic table is called a Group and represents a family of elements that have similar physical and chemical properties. Group IA is the Alkali Family; Group IIA is the Alkaline Earth Family; Group VIA is the Oxygen Family; Group VIIA is the Halogen Family. On the left side of the table are Group IA elements (except hydrogen), which are soft metals that undergo similar chemical reactions. The elements in Group IIA form similar compounds and are much harder than their neighbors in Group IA.

As shown in the previous section, there are some exceptions to the generalizations concerning chemical properties and the periodic table. The most accurate observation is that all elements within a particular group have similar physical and chemical properties.

This observation is most accurate at the extreme sides of the table. All elements in Group 0 are unreactive gases, and all elements in Group VIIA have similar chemical properties, although there is a gradual change in physical properties. For example, fluorine (F) is a gas while iodine (I) is a solid at room temperature.

Groups with a B designation (IB through VIIB) and Group VIII are called transition groups. In this region of the table, exceptions begin to appear. Within any group in this region, all the elements are metals, but their chemical properties may differ. In some cases, an element may be more similar to neighbors within its period than it is to elements in its group. For example, iron (Fe) is more similar to cobalt (Co) and nickel (Ni) than it is to ruthenium (Ru) and osmium (Os). Most of these elements have several charges, and their ions in solution are colored (ions of all other elements are colorless).

The line separating metals from nonmetals cuts across several groups. In this region of the table, the rule of group similarities loses much of its usefulness. In Group IVA, for example, carbon (C) is a nonmetal; silicon (Si) and germanium (Ge) are semi-metals; and tin (Sn) and lead (Pb) are metals.



Chemical activity can also be determined from position in the periodic table. The most active metals are the members of the Alkali Family, e.g., cesium (Cs) and francium (Fr). The most active nonmetals are the members of the Halogen Family, e.g., fluorine (F) and chlorine (Cl). The Noble Gases in Group 0 are inert. The activity of metals decreases when proceeding to the right in the periodic table; the activity of nonmetals decreases when proceeding to the left.

### **Atomic Structure of Electrons**

Based on experimental data, it is known that chemical reactions involve only the electrons in atoms. In fact, only some of the electrons are involved. Because chemical properties are periodic, there must also be a periodic characteristic about electrons. This characteristic is the manner in which electrons are arranged in the atom. Electrons are in constant motion around the nucleus. They have both kinetic and potential energy, and their total energy is the sum of the two. The total energy is quantized; that is, there are definite, discrete values of total energy that atomic electrons can possess. These energy states can be visualized as spherical shells around the nucleus separated by forbidden areas where electrons cannot exist in a stable state. This sort of arrangement is illustrated in Figure 5.

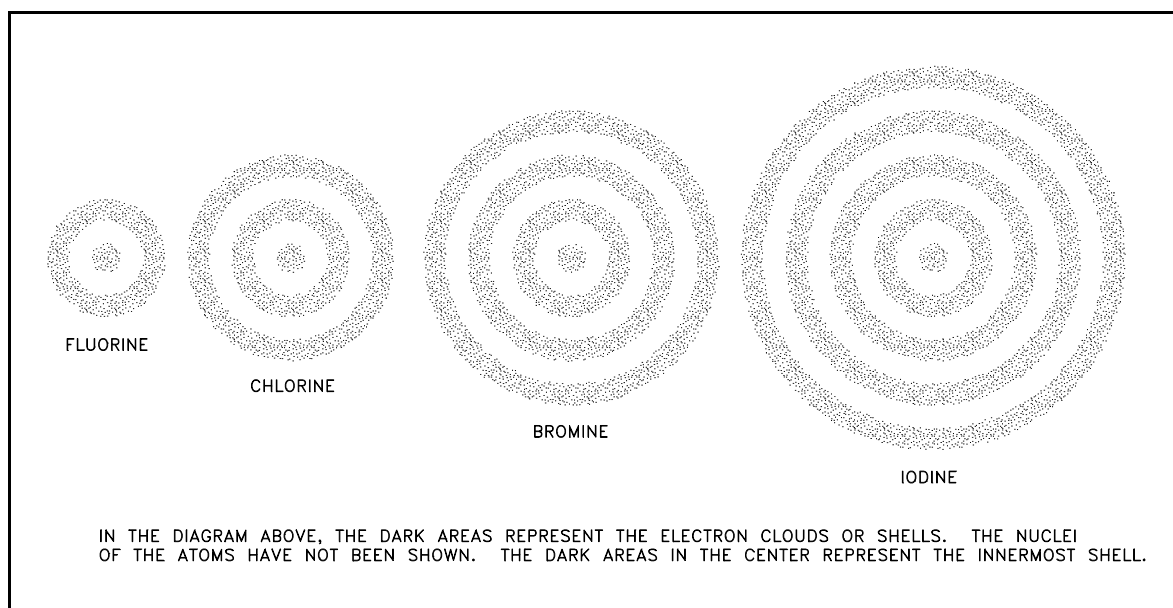

Figure 5 Electron Shells of Atoms

It is customary to speak of electron shells around the nucleus, and the shells are referred to by number. The first, or No. 1, shell is the one nearest the nucleus; the second, or No. 2, shell is next; then the third, or No. 3, shell; and so on in numerical order. In general, electrons closer to the nucleus have a lower energy state. Atomic electrons always seek the lowest energy state available.

The electron shells represent major energy states of electrons. Each shell contains one or more subshells called orbitals, each with a slightly different energy. In order of increasing energy, the orbitals are designated by the small letters s, p, d, f, g, h.

No two shells consist of the same number of orbitals. The first shell contains only one orbital, an s orbital. The second shell contains s and p orbitals. In general, each higher shell contains a new type of orbital:

the first shell contains an s orbital,  
 the second shell contains s and p orbitals,  
 the third shell contains s, p, and d orbitals,  
 the fourth shell contains s, p, d, and f orbitals,

and so on. Each orbital can hold a definite maximum number of electrons. There is also a limit to the number of electrons in each shell and the limit increases as one goes to higher shells. The numbers of electrons that can occupy the different orbitals and shells are shown in Table 4.

<b>TABLE 4</b>			
<b>Electrons, Orbital, and Shell Relationships in Atomic Structure</b>			
Shell Number	Type of Orbitals	Maximum Number of Electrons in Each Orbital	Maximum Total Electrons in shell
1	s	2	2
2	s	2	8
	p	6	
3	s	2	18
	p	6	
	d	10	
4	s	2	32
	p	6	
	d	10	
	f	14	
5	s	2	50
	p	6	
	d	10	
	f	14	
	g	18	

A more specific statement can now be made about which electrons are involved in chemical reactions. Chemical reactions involve primarily the electrons in the outermost shell of an atom. The term outermost shell refers to the shell farthest from the nucleus that has some or all of its allotted number of electrons. Some atoms have more than one partially-filled shell. All of the partially-filled shells have some effect on chemical behavior, but the outermost one has the greatest effect. The outermost shell is called the valence shell, and the electrons in that shell are called valence electrons. The term *valence* (of an atom) is defined as the number of electrons an element gains or loses, or the number of pairs of electrons it shares when it interacts with other elements.

The periodic chart is arranged so that the valence of an atom can be easily determined. For the elements in the A groups of the periodic chart, the number of valence electrons is the same as the group number; that is, carbon (C) is in Group IVA and has four valence electrons. The noble gases (Group 0) have eight in their valence shell with the exception of helium, which has two.

The arrangement in which the outermost shell is either completely filled (as with He and Ne) or contains eight electrons (as with Ne, Ar, Kr, Xe, Rn) is called the inert gas configuration. The inert gas configuration is exceptionally stable energetically because these inert gases are the least reactive of all the elements.

The first element in the periodic table, hydrogen, does not have properties that satisfactorily place it in any group. Hydrogen has two unique features: (a) the highest energy shell of a hydrogen atom can hold only two electrons, in contrast to all others (except helium) that can hold eight or more; and (b) when hydrogen loses its electron, the ion formed,  $H^+$ , is a bare nucleus. The hydrogen ion is very small in comparison with a positive ion of any other element, which must still have some electrons surrounding the nucleus. Hydrogen can either gain or lose an electron. It has some properties similar to Group IA elements, and some similar to Group VIIA elements.

The number of electrons in the outer, or valence, shell determines the relative activity of the element. The elements are arranged in the periodic table so that elements of the same group have the same number of electrons in the outer shell (except for the Transition Groups). The arrangement of electrons in the outer shell explains why some elements are chemically very active, some are not very active, and others are inert. In general, the fewer electrons an element must lose, gain, or share to reach a stable shell structure, the more chemically active the element is. The likelihood of elements forming compounds is strongly influenced by this valence shell and on the stability of the resulting molecule. The more stable the molecules are, the more likely these molecules are to form.

## Summary

The important information from this chapter is summarized below.

### Periodic Table Summary

- The subdivisions of the periodic table are periods, groups, and classes. The horizontal rows are called periods. The vertical columns are called groups. The entire table consists of three classes: metals, non-metals, and semi-metals.
- The subdivisions of the periodic chart have been explained such that the student should be able to identify them if given a periodic table.
- Elements of the same group share certain physical and chemical characteristics. Examples of the characteristics of several groups are listed below.

Group 0 contains elements that are unreactive gases.

Group IA contains elements that are chemically active soft metals.

Group VIIA contains elements that are chemically active nonmetals.

Groups IB through VIIB and VIII are called transition groups and elements found in them display properties of metals.

- The *valence* of an atom is defined as the number of electrons an element gains or loses, or the number of pairs of electrons it shares when it interacts with other elements.

---

## CHEMICAL BONDING

---

*The development of matter, no matter what the form, is the result of the practical application of the assumptions, hypotheses, theories, and laws that chemists have formulated from their research into the nature of matter, energy, and change. This chapter will address some of these theories and laws. Chemical bonds and how atoms bond to form molecules will be discussed. In addition, an introduction to organic chemistry is provided.*

**EO 2.1 DEFINE the following terms:**

- |           |                             |           |                       |
|-----------|-----------------------------|-----------|-----------------------|
| <b>a.</b> | <b>Ionic bonds</b>          | <b>c.</b> | <b>Covalent bonds</b> |
| <b>b.</b> | <b>Van der Waals forces</b> | <b>d.</b> | <b>Metallic bonds</b> |

**EO 2.2 DESCRIBE the physical arrangement and bonding of a polar molecule.**

**EO 2.3 DESCRIBE the three basic laws of chemical reactions.**

**EO 2.4 STATE how elements combine to form chemical compounds.**

**EO 2.5 EXPLAIN the probability of any two elements combining to form a compound.**

**EO 2.6 DEFINE the following terms:**

- |           |                   |           |                    |
|-----------|-------------------|-----------|--------------------|
| <b>a.</b> | <b>Mixture</b>    | <b>d.</b> | <b>Solute</b>      |
| <b>b.</b> | <b>Solvent</b>    | <b>e.</b> | <b>Solution</b>    |
| <b>c.</b> | <b>Solubility</b> | <b>f.</b> | <b>Equilibrium</b> |

---

### **Chemical Bonding**

As stated in the previous chapter, the number of electrons in the outer, or valence, shell determines the relative activity of the element. The arrangement of electrons in the outer shell explains why some elements are chemically very active, some are not very active, and others are inert. In general, the fewer electrons an element must lose, gain, or share to reach a stable shell structure, the more chemically active the element is. The likelihood of elements forming compounds is strongly influenced by the completion of the valence shell and by the stability of the resulting molecule. The more stable the resulting molecules are, the more likely these molecules are to form. For example, an atom that "needs" two electrons to completely fill the valence shell would rather react with another atom which must give up two electrons to satisfy its valence.

In the case of  $H^+ + Br^-$ , this is likely to take place because the exchange would satisfy the needs of both atoms. Although there is far more to consider than just the number of valence electrons, this is a good rule of thumb.

If the atom needed two electrons and only picked up one, it would still actively seek out an additional electron. The reaction of  $H^+ + Te^{2-}$  is far less likely to take place because the resulting molecule would still have an incomplete valence shell. Of course, the combining of two atoms, when both want to release or gain electrons, may take place (for example;  $H_2$  or  $O_2$ ) but is less probable when other atoms are available.

Atoms are joined or bonded together through this interaction of their electrons. There are several types of chemical bonds that hold atoms together; three will be discussed, ionic, covalent, and metallic.

## **Ionic Bonds**

An *ionic bond* is formed when one or more electrons is wholly transferred from one element to another, and the elements are held together by the force of attraction due to the opposing charges. An example of ionic bonding is shown in Figure 6(A) for sodium chloride (table salt).

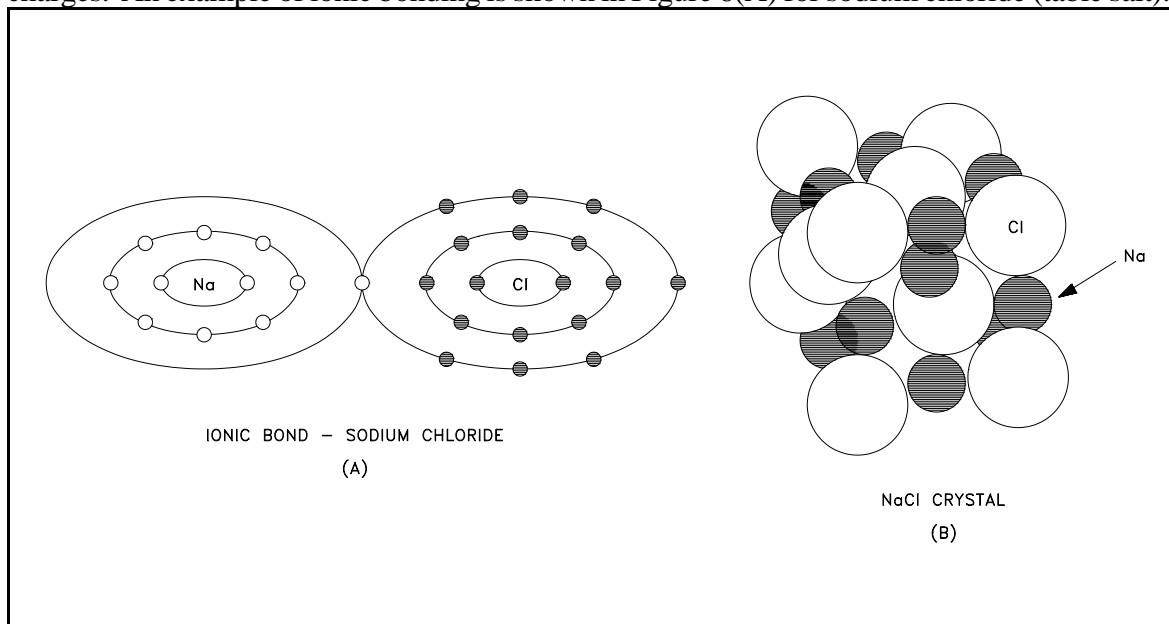

Figure 6 Ionic Bond, Sodium Chloride

The sodium atom loses the one electron in its outer shell to the chlorine atom, which uses the electron to fill its outer shell. When this occurs, the sodium atom is left with a +1 charge and the chlorine atom a -1 charge. The ionic bond is formed as a result of the attraction of the two oppositely-charged particles. No single negatively-charged ion has a greater tendency to bond to a particular positively-charged ion than to any other ion.

Because of this, the positive and negative ions arrange themselves in three dimensions, as shown in Figure 6(B), to balance the charges among several ions. In sodium chloride, for example, each chloride ion is surrounded by as many sodium ions as can easily crowd around it, namely six. Similarly, each sodium ion is surrounded by six chloride ions. Therefore, each chloride ion is bonded to the six nearest sodium ions and bonded to a lesser extent to the more distant sodium ions. Accordingly, the ionic bond is a force holding many atoms or ions together rather than a bond between two individual atoms or ions.

## Covalent Bonds

A *covalent bond* is formed when one or more electrons from an atom pair off with one or more electrons from another atom and form overlapping electron shells in which both atoms share the paired electrons. Unlike an ionic bond, a covalent bond holds together specific atoms. Covalent bonding can be single covalent, double covalent, or triple covalent depending on the number of pairs of electrons shared. Figure 7 shows the bonding that occurs in the methane molecule, which consists of four single covalent bonds between one carbon atom and four hydrogen atoms.

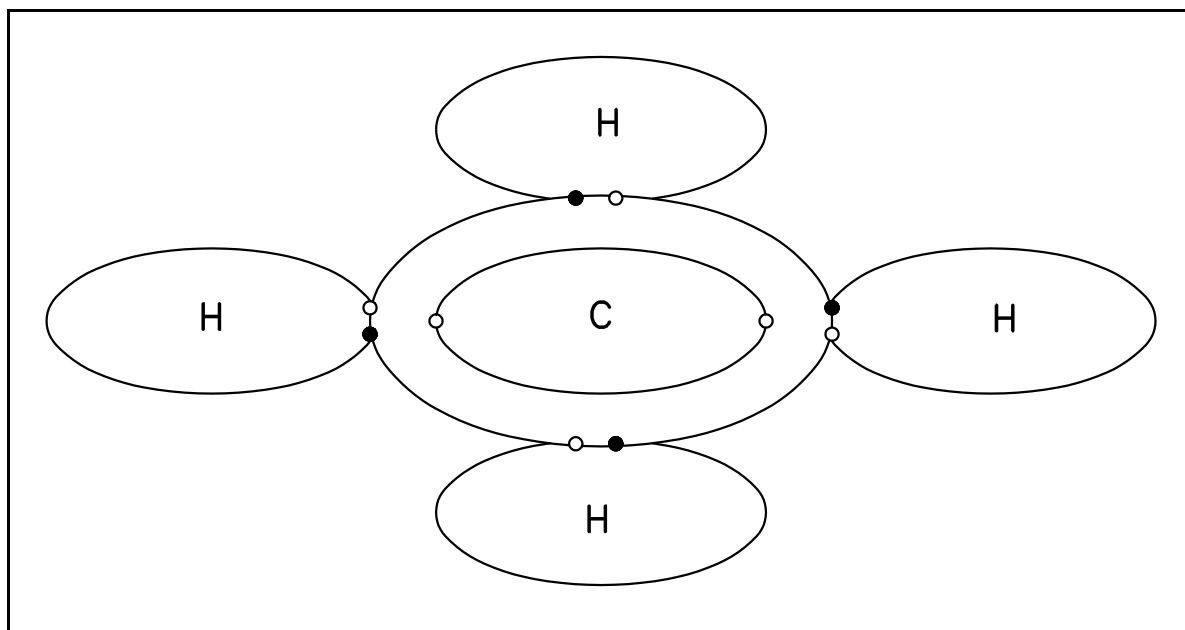

Figure 7 Covalent Bond, Methane  $\text{CH}_4$

Two double covalent bonds result when carbon dioxide, which consists of one carbon atom and two oxygen atoms, is formed. Four pairs of electrons are shared by the carbon atom, two from each of the two oxygen atoms as shown in Figure 8. A combination of two electrons form a combination of lower energy than their energy when separated. This energy difference represents the force that binds specific atoms together.

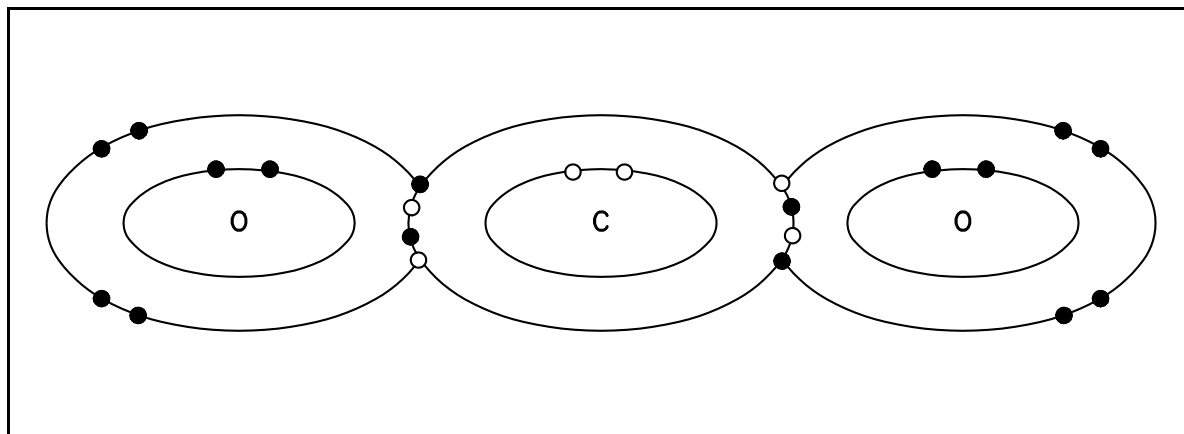
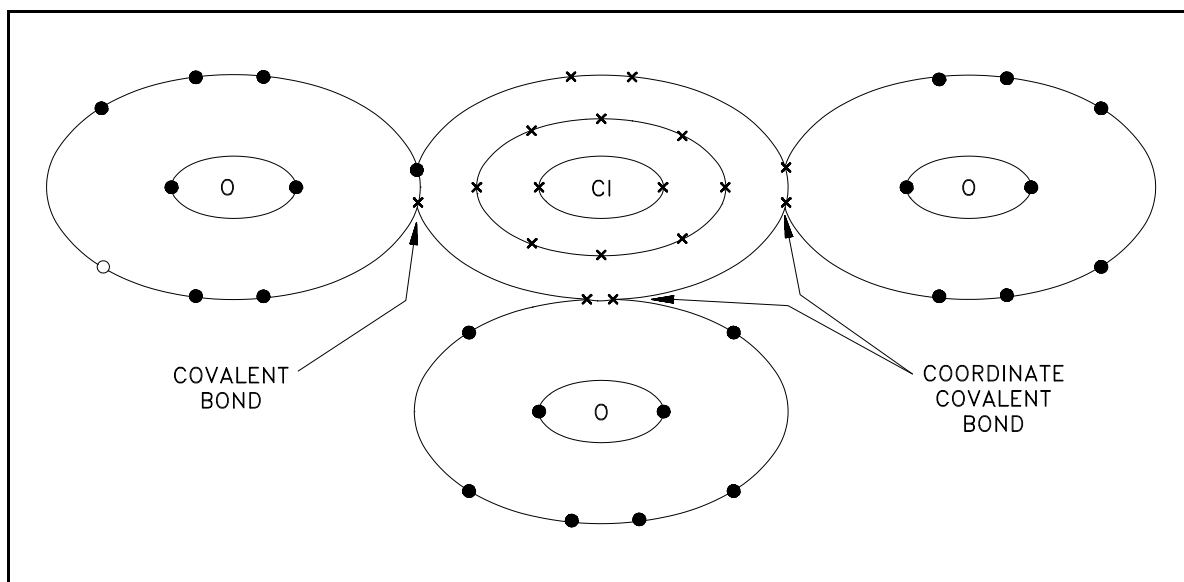

Figure 8 Formation of the Carbon Dioxide Molecule

When both shared electrons in a covalent bond come from the same atom, the bond is called a coordinate covalent bond. Although both shared electrons come from the same atom, a coordinate covalent bond is a single bond similar in properties to a covalent bond. Figure 9 illustrates the bonds of the negatively-charged chlorate ion. The ion consists of one chlorine atom and three oxygen atoms with a net charge of -1, and is formed with two coordinate covalent bonds and one covalent bond. The chlorine atom has effectively gained an electron through the covalent bond, which causes the overall negative charge.

Figure 9 Coordinate Covalent Bond, Chlorate Ion  $\text{ClO}_3^-$ 

Covalent bonds can be either polar or nonpolar. When the shared pair of electrons is not shared equally, one end of the bond is positive, and the other end is negative. This produces a bond with two poles called a polar covalent bond.



Molecules having polar covalent bonds are called dipolar or *polar molecules*. Water is an example of a polar molecule. When two atoms of the same element share one or more pairs of electrons (such as H or N), each atom exerts the same attraction for the shared electron pair or pairs. When the electron pairs are distributed or shared equally between the two like atoms, the bond is called a nonpolar covalent bond. If all the bonds in a molecule are of this kind, the molecule is called a nonpolar covalent molecule.

## **Metallic Bonds**

Another chemical bonding mechanism is the *metallic bond*. In the metallic bond, an atom achieves a more stable configuration by sharing the electrons in its outer shell with many other atoms. Metallic bonds prevail in elements in which the valence electrons are not tightly bound with the nucleus, namely metals, thus the name metallic bonding. In this type of bond, each atom in a metal crystal contributes all the electrons in its valence shell to all other atoms in the crystal.

Another way of looking at this mechanism is to imagine that the valence electrons are not closely associated with individual atoms, but instead move around amongst the atoms within the crystal. Therefore, the individual atoms can "slip" over one another yet remain firmly held together by the electrostatic forces exerted by the electrons. This is why most metals can be hammered into thin sheets (malleable) or drawn into thin wires (ductile). When an electrical potential difference is applied, the electrons move freely between atoms, and a current flows.

## **Van der Waals Forces**

In addition to chemical bonding between atoms, there is another type of attractive force that exists between atoms, ions, or molecules known as van der Waals forces.

These forces occur between the molecules of nonpolar covalent substances such as  $H_2$ ,  $Cl_2$ , and He. These forces are generally believed to be caused by a temporary dipole, or unequal charge distribution, as electrons constantly move about in an atom, ion, or molecule. At a given instant, more electrons may be in one region than in another region, as illustrated in Figure 10.

The temporary dipole induces a similar temporary dipole on a nearby atom, ion, or molecule. Every instant, billions of these temporary dipoles form, break apart, and reform to act as a weak electrostatic force of attraction known as *van der Waals forces*.

It is important to note that van der Waals forces exist between all kinds of molecules. Some molecules may have these forces, as well as dipole or other intermolecular forces. Van der Waals forces, however, are the only intermolecular bonds between nonpolar covalent molecules such as  $H_2$ ,  $Cl_2$ , and  $CH_4$ . The number of electrons in a substance increases as the gram molecular mass (mass in grams of one mole of compound) increases. Therefore, the strength of the van der Waals forces between substances increases with increasing gram molecular mass.

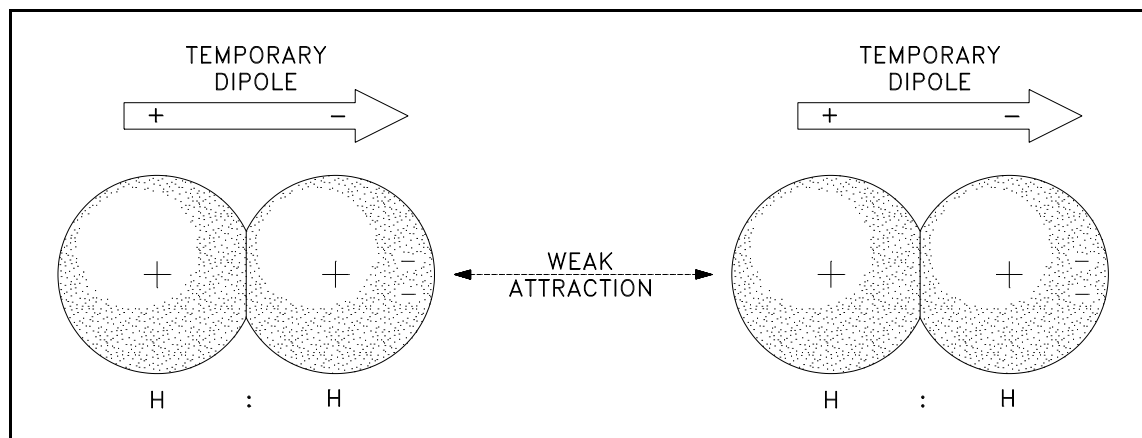

Figure 10 Van der Waals Forces

Van der Waals forces are small compared to the forces of chemical bonding and are significant only when the molecules are very close together.

## Organic Chemistry

*Organic chemistry* is defined as the chemistry of carbon compounds. The compounds of carbon are in forms of living things and in synthetic fabrics and plastics. Organic chemistry is so broad a topic that it is usually subdivided into smaller areas. How the carbon is combined and what it is combined with determines the subdivision for a particular compound. These subdivisions are referred to as families or classes.

The carbon atoms can combine to form straight chains, rings, or branched chains. The bonds between carbon atoms can be single, double, triple or a combination of these. Other atoms (H, O, N, S, P) and the halogens can be attached to the carbon atoms to yield derivatives.

The large family of organic compounds containing only carbon and hydrogen are called hydrocarbons. These can be further divided into two broad classes, aliphatic (fatty) and aromatic (fragrant).

Aliphatic hydrocarbons are divided into two categories, saturated and unsaturated and into subdivisions alkanes, alkenes, and alkynes. These subdivisions reflect the type of bond between the carbon atoms.

## Alkanes

*Alkanes* are saturated compounds which have single bonds between carbon atoms and contain the maximum number of hydrogen atoms possible. Each carbon is flanked by four covalent bonds and each hydrogen atom shares one pair of electrons with a carbon atom, as illustrated in Figure 11.

The general formula for alkanes is  $C_nH_{2n+2}$ . The alkanes are colorless, practically odorless, insoluble in water, and readily soluble in nonpolar solvents such as benzene or ether.

Alkanes are low in reactivity. The reactions they do undergo are called halogenation, thermal decomposition (cracking), and combustion. These are summarized below.

Halogenation occurs when a hydrogen atom is replaced with a halogen atom. This is referred to as a substitution reaction. There is no limit to how many hydrogen atoms can be replaced in one molecule.

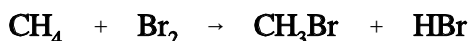

Thermal decomposition or cracking is the process of breaking large molecules into smaller ones. Using heat as a catalyst, propane can be broken into methane and ethylene:

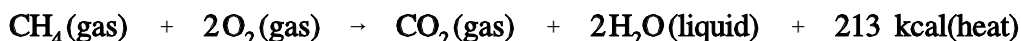

Combustion occurs when an alkane is burned, the products being carbon dioxide gas, water, and heat. These reactions are highly exothermic and as such the hydrocarbons are frequently used for fuel.

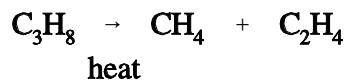

## Alkenes

*Alkenes* are hydrocarbons containing two fewer hydrogen atoms than the corresponding alkane. The general formula for alkenes is  $C_nH_{2n}$ . These molecules will have a double bond as illustrated in Figure 12.

Because there are fewer hydrogen atoms than the maximum possible, alkenes are unsaturated hydrocarbons. The chief source for alkenes is the cracking of alkanes.

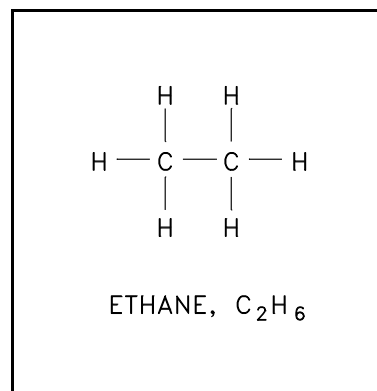
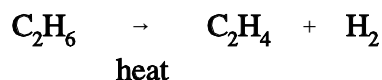

Figure 11 Alkane

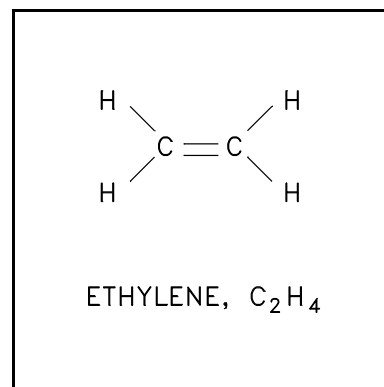

Figure 12 Alkene

## Alkynes

The third of the aliphatic hydrocarbons are the *alkynes*. These compounds are unsaturated like the alkenes. They contain two fewer hydrogens than the corresponding alkane,  $C_nH_{2n-2}$ . The alkyne hydrocarbons contain a triple bond between at least one set of carbon atoms as illustrated in Figure 13.

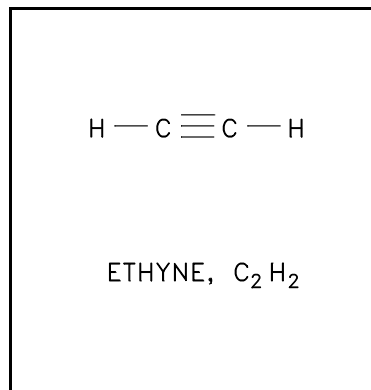

Figure 13 Alkyne

## Aromatics

The other broad class of hydrocarbons is the aromatic hydrocarbon. Rather than being arranged in straight chains, as the aliphatics are, these are cyclic formations such as in benzene. The derivatives of cyclic hydrocarbons have pleasant (sometimes toxic) odors. The benzene in rubber cement is a familiar odor. The cyclic compounds have alternating single - double bonds as illustrated in Figure 14.

Aromatic hydrocarbons are very stable chemically, and act very much like alkanes. They will undergo substitution reactions rather than additions.

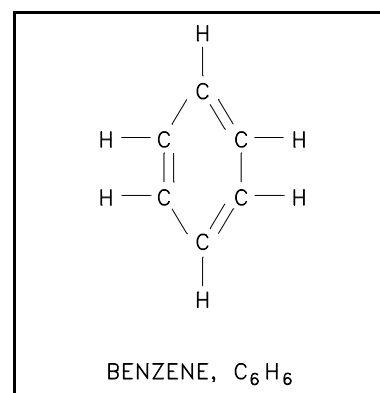

Figure 14 Aromatic

## Alcohols

Alcohol is an aliphatic hydrocarbon with a hydroxyl (OH) group substituting for one or more hydrogens as illustrated in Figure 15.

The -OH functional group does not behave in an ionic manner in the case of alcohols. The alcohols are molecular, not ionic, in nature. Alcohols are versatile compounds which are often used to make nearly every other kind of aliphatic compound.

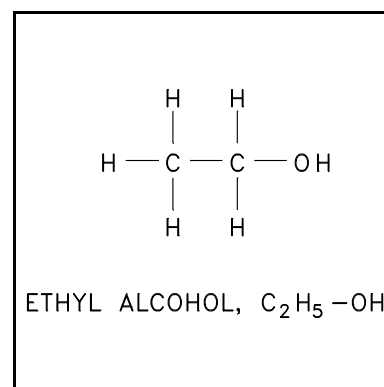

Figure 15 Alcohol



## **Forming Chemical Compounds**

Chemistry and all other sciences are based on facts established through experimentation. A scientific law is a condensed statement of facts which has been discovered by experiment.

There are three basic laws that apply to chemical reactions. They are the Law of Conservation of Mass, the Law of Definite Proportions, and the Law of Multiple Proportions. These laws are described here to help the reader in understanding the reasons elements and compounds behave as they do.

### 1. The Law of Conservation of Mass

This law states that in a chemical reaction the total mass of the products equals the total mass of the reactants. Antoine Lavoisier, a French chemist, discovered that when tin reacts with air in a closed vessel, the weight of the vessel and its contents is the same after the reaction as it was before. Scientists later discovered that whenever energy (heat, light, radiation) is liberated during a reaction, a very small change in mass does occur, but this change is insignificant in ordinary chemical reactions.

### 2. The Law of Definite Proportions

This law states that no matter how a given chemical compound is prepared, it always contains the same elements in the same proportions by mass. John Dalton, an English physicist, discovered that when various metals are burned or oxidized in air, they always combine in definite proportions by weight.

For example, one part by weight of oxygen always combines with 1.52 parts by weight of magnesium or 37.1 parts by weight of tin. This law results from the fact that a compound is formed by the combination of a definite number of atoms of one element with a definite number of atoms of another.

### 3. The Law of Multiple Proportions

This law states that if two elements combine to form more than one compound, the masses of one of the elements combining with a fixed mass of the other are in a simple ratio to one another. For example, carbon forms two common compounds with oxygen; carbon monoxide and carbon dioxide. With carbon monoxide (CO), 1.33 grams of oxygen are combined with 1 gram of carbon. With carbon dioxide (CO<sub>2</sub>), 2.67 grams of oxygen are combined with 1 gram of carbon. Therefore, the masses of oxygen combining with a fixed mass of carbon are in the ratio 2:1.

## **Combining Elements**

The Laws of Definite Proportions and Multiple Proportions and the related portions of atomic theory form the bases for most quantitative calculations involving chemical reactions. Applying the basic chemical laws to chemical bonding will help the reader to understand the probability and proportions involved in chemical reactions. Regardless of the type of bond (ionic, covalent, coordinate covalent, or metallic), specific amounts of one element will react with specific amounts of the element(s) with which it is combined.

If two substances are placed together in a container, in any ratio, the result is a *mixture*. When a teaspoon of sugar is added to a glass of water, it will slowly dissolve into the water and disappear from view. As a result, the molecules of sugar are evenly distributed throughout the water and become mixed with the water molecules. Because the sugar and water mixture is uniform throughout, it is said to be homogeneous. A homogeneous mixture of two or more substances is called a *solution*. The reason solutions are classified as mixtures rather than as compounds is because the composition is not of fixed proportion.

All solutions consist of a solvent and one or more solutes. The *solvent* is the material that dissolves the other substance(s). It is the dissolving medium. In the water-sugar solution, the water is the solvent. The substances that dissolve in the solution are called *solutes*. In the water-sugar solution, sugar is the solute. It is not always easy to identify which is the solvent and which is the solute (for example, a solution of half water and half alcohol).

Solutions can exist in any of the three states of matter, solid, liquid, or gas. The earth's atmosphere is a gaseous solution of nitrogen, oxygen, and lesser amounts of other gases. Wine (water and alcohol) and beer (water, alcohol, and CO<sub>2</sub>) are examples of liquid solutions. Metal alloys are solid solutions (14-karat gold is gold combined with silver or copper).

One factor that determines the degree and/or rate at which a reaction takes place is solubility. *Solubility* is defined as the maximum amount of a substance that can dissolve in a given amount of solvent at a specific temperature. At this point, the solution is said to be saturated. A solution is saturated when equilibrium is established between the solute and the solvent at a particular temperature. *Equilibrium* is the point at which the rates of the forward and reverse reactions are exactly equal for a chemical reaction if the conditions of reaction are constant.

Kinetics is the study of the factors which affect the rates of chemical reactions. There are five principle factors to consider: concentration, temperature, pressure, the nature of the reactants, and the catalyst.

## **Summary**

The important information in this chapter is summarized below.

### **Chemical Bonding Summary**

- The following terms are defined in this chapter:

An ionic bond occurs where one or more electrons are wholly transferred from one element to another, and the elements are held together by the force of attraction due to the opposite polarity of the charge.

The van der Waals forces are attractions between the molecules of nonpolar covalent substances. These forces are generally believed to be caused by a temporary dipole, or unequal charge distribution, as electrons constantly move about in an atom, ion, or molecule.

A covalent bond is a bond in which one or more electrons from an atom pair off with one or more electrons from another atom and form overlapping electron shells in which both atoms share the paired electrons.

Metallic bonds are bonds where the atoms achieve a more stable configuration by sharing the electrons in their outer shell with many other atoms.

A mixture is defined as two substances placed together in a container, in any ratio and the composition is not of fixed proportion.

A solution is a homogeneous mixture of two or more substances.

A solute is defined as the substance that dissolves in a solution.

A solvent is defined as the material that dissolves the other substance(s) in a solution. It is the dissolving medium.

Solubility is defined as the maximum amount of a substance which will dissolve in a given amount of solvent at a specific temperature.

- When the shared pair of electrons which are forming the bond in a molecule are not shared equally, the resulting molecule will have a positive end and a negative end. This type of bond is a polar covalent bond. The molecules are called dipolar or polar molecules.



### **Chemical Bonding Summary (Cont.)**

- In general, the fewer electrons an element must lose, gain, or share to reach a stable shell structure, the more chemically active the element is. The likelihood of elements forming compounds is strongly influenced by the valence shell and on the stability of the resulting molecule. The more stable the molecules are, the more likely these molecules are to form.
- Elements combine in specific ratios, regardless of the type of bond, to form molecules.
- The three basic laws of chemical reactions are discussed:
  - (1) The Law of Conservation of Mass - "In a chemical reaction the total mass of the products equal the total mass of the reactants."
  - (2) The Law of Definite Proportions - "No matter how a given chemical compound is prepared, it always contains the same elements in the same proportions by mass."
  - (3) The Law of Multiple Proportions - "If two elements combine together to form more than one compound, then the masses of one of these elements combining with a fixed mass of the other are in a simple ratio to one another."

---

## CHEMICAL EQUATIONS

---

*This chapter will discuss the method of qualifying solutions. The balancing of the chemical equations will also be explained in this chapter.*

**EO 2.7      STATE Le Chatelier's principle.**

**EO 2.8      DEFINE the following terms:**

- |           |                 |           |                  |
|-----------|-----------------|-----------|------------------|
| <b>a.</b> | <b>ppm</b>      | <b>c.</b> | <b>Density</b>   |
| <b>b.</b> | <b>Molarity</b> | <b>d.</b> | <b>Normality</b> |

**EO 2.9      BALANCE chemical equations that combine elements and/or compounds.**

---

### Le Chatelier's Principle

The effect of temperature on solubility can be explained on the basis of *Le Chatelier's Principle*. Le Chatelier's Principle states that if a stress (for example, heat, pressure, concentration of one reactant) is applied to an equilibrium, the system will adjust, if possible, to minimize the effect of the stress. This principle is of value in predicting how much a system will respond to a change in external conditions. Consider the case where the solubility process is endothermic (heat added).



An increase in temperature puts a stress on the equilibrium condition and causes it to shift to the right. The stress is relieved because the dissolving process consumes some of the heat. Therefore, the solubility (concentration) increases with an increase in temperature. If the process is exothermic (heat given off).



A temperature rise will decrease the solubility by shifting the equilibrium to the left.

How much solute is dissolved in a solution is very important when the solution is being made for a specific use. To say there is a little, a lot, or a bit would not be very accurate if a specific concentration is required. There are a few common and accurate methods used to express concentration. These are density, molarity, normality, and parts per million.

## Density

*Density* is the measure of the mass per unit volume of a material (density = mass/volume). Density is a characteristic of a substance; mass and volume are not. Mass and volume vary with size but density will remain constant. Temperature will affect the density of a substance and the temperature at which density for that substance was determined is usually reported along with the density value.

## Molarity

A useful way to express exact concentrations of solutions is *molarity*. Molarity is defined as moles of solute per liter of solution. Molarity is symbolized by the capital letter M. It can be expressed mathematically as follows.

$$\text{molarity (M)} = \frac{\text{moles of solute (n)}}{\text{liters of solution (V)}}$$

Notice that the moles of solute are divided by the liters of solution not solvent. One liter of one molar solution will consist of one mole of solute plus enough solvent to make a final volume of one liter.

Example 1:

Prepare one molar solution of NaCl.

Solution:

- a) Calculate the molecular weight of the salt

$$1 \text{ atom of Na} = 22.989 \text{ amu}$$

$$\underline{1 \text{ atom of Cl} = 35.453 \text{ amu}}$$

$$1 \text{ molecule of NaCl} = 58.442 \text{ amu}$$

One mole is equal to the gram molecular weight, so one mole = 58.442 grams.

- b) 58.442 grams of NaCl is weighed out and sufficient water is added to bring the solution to one liter.

Example 2:

Prepare 3 liters of a 2M NaOH solution.

Solution:

Calculate the amount of NaOH required to prepare the solution.

$$\text{a) molarity (M)} = \frac{\text{moles of solute}}{\text{volume of solution (l)}}$$

$$2\text{M} = \frac{\text{X moles of solute}}{3 \text{ liters}}$$

$$\text{b) substituting: (3 liters) (2M) = 6 moles NaOH}$$

$$\frac{40 \text{ grams NaOH}}{1 \text{ mole NaOH}} \times 6 \text{ moles NaOH} = 240 \text{ grams NaOH}$$

Therefore, to prepare 3 liters of a 2M NaOH solution, 240 grams of NaOH must be weighed out and dissolved in water to make a volume of exactly 3 liters.

## Normality

The normal concentration is another method for expressing the concentration of solutions. *Normality* (N) is defined as the number of equivalents of solute dissolved in one liter of solution.

$$\text{Normality (N)} = \frac{\text{equivalents of solute}}{\text{liter of solution}}$$

One equivalent of acid is the amount of acid necessary to give up one mole of hydrogen ions in a chemical reaction. One equivalent of base is the amount of base that reacts with one mole of hydrogen ions. When expressing the concentrations of bases, normality refers to the number of available hydroxyl ions. Because hydrogen and hydroxyl ions combine on a one-to-one basis, one OH<sup>-</sup> is equivalent to one H<sup>+</sup> ion.

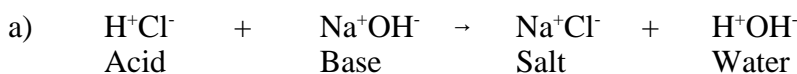

Notice that in reaction a), one mole of HCl yields one equivalent per mole or one mole of H<sup>+</sup> ions. H<sub>2</sub>SO<sub>4</sub> has two equivalents per mole or two H<sup>+</sup> ions because each mole of the compound can release two moles of hydrogen ions.

The number of equivalents of an acid or base can be determined from equivalent weight. The *equivalent weight* is defined as the molecular weight of the acid or base divided by the number of replaceable hydrogen or hydroxyl ions.

Example:

The equivalent weight of H<sub>2</sub>SO<sub>4</sub> is:

$$\frac{98.0734 \text{ grams (molecular wt.)}}{2 \text{ H}^+ \text{ ions}} = 49 \text{ grams/equivalent.}$$

This means 49 grams of H<sub>2</sub>SO<sub>4</sub> is equal to one equivalent of H<sub>2</sub>SO<sub>4</sub>. If there is a one liter solution that contains 78.32 grams H<sub>2</sub>SO<sub>4</sub>, the number of equivalents is:

$$\frac{78.32 \text{ grams H}_2\text{SO}_4}{1} \times \frac{1 \text{ equivalent}}{49 \text{ grams H}_2\text{SO}_4} = 1.6 \text{ equivalents.}$$

Since normality is equal to the number of equivalents per liter, the normality of this solution is 1.6 equivalents/liter, or 1.6 N.

### **Parts per Million**

Another term used to describe the specific concentration of a solution is parts per million or ppm. The term *ppm* is defined as the concentration of a solution in units of one part of solute to one million parts solvent. One ppm equals one milligram of solute per liter of solution. Another term, parts per billion (ppb), is defined as one part solute per one billion parts solvent. One ppb is equal to one microgram solute per liter of solution. These two terms are usually used for very dilute solutions.

## **Chemical Equations**

The chemical equation is simply a representation of a chemical reaction in the chemist's shorthand. In a chemical equation, the substances originally present are called the reactants and the new substances being formed are called the products. In the chemical reaction, the reactants are on the left of the arrow and the products are on the right of the arrow. For example, when looking at the combination of hydrogen and oxygen into water, the water molecule would be the product on the right.

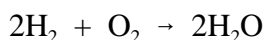

If looking at the decomposition of water, the hydrogen and oxygen would be the products and the water is the reactant. The arrow means yields and is used to separate the reactants from the products. It also indicates the direction of the reaction as illustrated below.

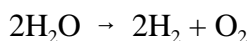

The single arrow in the above equation implies that the reaction will proceed in only one direction until it subsides or stops. If the reaction is reversible, that is, it can proceed left to right and right to left until it reaches an equilibrium, then a double arrow is used.

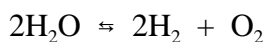

When writing an equation, always place the reactant on the left and the products on the right even in the case of a reversible reaction.

A chemical equation represents not only the reaction, but also shows the number of atoms or molecules entering into and produced by the reaction. The formulas must be balanced correctly based on the valences of the constituent elements.

## **Balancing Chemical Equations**

The number of atoms or molecules of each substance is shown by the coefficients in the equation. Because atoms cannot be created or destroyed in a chemical reaction, a chemical equation must be balanced so that there are exactly the same number of atoms of each element on each side of the equation.

Example:

Explain the following chemical equation.

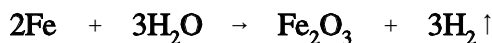

Solution:

This chemical equation shows that iron reacts with water to form ferric oxide and hydrogen gas (the vertical arrow  $\uparrow$  indicates a gas). This chemical equation also shows that for every two atoms of iron that react, three molecules of water are used to form one molecule of ferric oxide and three molecules of hydrogen gas. This is a balanced chemical equation. There are two iron atoms on each side of the equation; there are six hydrogen atoms on each side; and there are three oxygen atoms on each side.

There are no fixed rules for balancing chemical equations. Learning how is a matter of practice. The balancing of most equations can be accomplished by following the guidelines explained below.

Guidelines:

- a. Once the correct chemical formula for a compound is written in an equation, do not modify it.
- b. Select the compound with the greatest number of atoms. Then begin by balancing the element in that compound with the most atoms. There must be the same number of atoms of an element on each side of the equation. As a rule of thumb, this first element should not be hydrogen, oxygen, or a polyatomic ion.
- c. Balance the atoms of each element in the compound by placing the appropriate coefficient in front of the chemical symbol or formula.
- d. Next, balance the polyatomic ions. In some cases, the coefficient assigned in guideline 2 may have to be changed to balance the polyatomic ion.
- e. Balance the hydrogen atoms next, then the oxygen atoms. If these elements appear in the polyatomic ion it should not be necessary to balance them again.
- f. All coefficients will be whole numbers. The coefficients should be reduced to the lowest possible ratios.
- g. As simple as it sounds, check off each element as it is accounted for since this will prevent double inclusion or a missed atom.

Example 1:

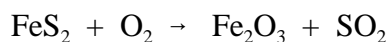

Solution 1:

Starting with  $\text{Fe}_2\text{O}_3$  (see guideline b), write  $2\text{FeS}_2 + \text{O} \rightarrow \frac{1}{2}\text{Fe}_2\text{O} + \frac{1}{2}\text{SO}$ , which balances the Fe on each side of the equation.

Now there are 4 S atoms on the left side so balance the S atoms by writing  $2\text{FeS}_2 + \text{O}_2 \rightarrow \text{Fe}_2\text{O}_3 + 4\text{SO}_2$ .

Everything is balanced except the O. There are now 2 O atoms on the left and 11 O atoms on the right. To get 11 O atoms on the left write  $2\text{FeS}_2 + 5.5\text{O}_2 \rightarrow \text{Fe}_2\text{O}_3 + 4\text{SO}_2$ .

This makes both sides of the equation balanced except the coefficients must be whole numbers (guideline f). To meet guideline f, multiply both sides by two which will bring the left side to a whole number of  $\text{O}_2$  molecules.

Thus, the solution is  $4\text{FeS}_2 + 11\text{O}_2 \rightarrow 2\text{Fe}_2\text{O}_3 + 8\text{SO}_2$ .

Example 2:

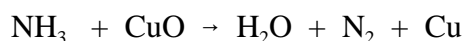

Solution 2:

Start with  $\text{NH}_3$  since there are two N atoms on the right of the equation. To balance the N atoms write  $2\text{NH}_3 + \text{CuO} \rightarrow \text{H}_2\text{O} + \text{N}_2 + \text{Cu}$  (guideline b).

Since the H appears in only the  $\text{NH}_3$  and  $\text{H}_2\text{O}$  and the  $\text{NH}_3$  has been balanced, the  $\text{H}_2\text{O}$  will be balanced. Write  $2\text{NH}_3 + \text{CuO} \rightarrow 3\text{H}_2\text{O} + \text{N}_2 + \text{Cu}$  (guideline e).

Oxygen appears only in  $\text{CuO}$  and in  $\text{H}_2\text{O}$ , and since the  $\text{H}_2\text{O}$  has been already been balanced write  $2\text{NH}_3 + 3\text{CuO} \rightarrow 3\text{H}_2\text{O} + \text{N}_2 + \text{Cu}$  (guideline e).

That leaves the Cu to be balanced. Thus, the solution is  $2\text{NH}_3 + 3\text{CuO} \rightarrow 3\text{H}_2\text{O} + \text{N}_2 + 3\text{Cu}$ .



Example 3:

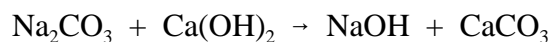

Solution 3:

There are two Na atoms on the left so start with the Na by writing  $\text{Na}_2\text{CO}_3 + \text{Ca}(\text{OH})_2 \rightarrow 2\text{NaOH} + \text{CaCO}_3$  (guideline b).

By adding the 2, the equation is now completely balanced. This equation illustrates that not all equations are that hard to balance.

Most chemical equations do not indicate a number of important facts about the chemical reactions they represent. Chemical equations do not necessarily describe the path by which the substances reacting are converted to products.

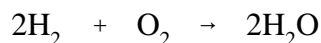

The equation would seem to imply that two molecules of hydrogen collide with one molecule of oxygen, and two molecules of water are produced. The actual mechanism by which this reaction takes place is much more complicated and involves a series of processes. Chemical equations do not indicate the rate at which the reaction proceeds, or even whether the reaction will occur in a finite time. In many cases, reactions will occur only under a particular set of circumstances and then only at a definite rate. Chemical equations do not show whether the reaction proceeds to completion or, if incomplete, the extent of reaction. In most cases, the substances that react never completely disappear; however, their concentration may be exceedingly small. Reactions that do not go to completion are usually represented in chemical equations by using double horizontal arrows  $\rightleftharpoons$ . In general, a reaction will go to completion only if one or more of the products is removed from the field of the reaction. This is often accomplished if one of the products is a gas or is insoluble in the reaction mixture.

In the discussion of chemical equations, emphasis is normally placed on the number of atoms or molecules involved in the reaction. However, chemical equations are very effective in representing chemical reactions on a macroscopic scale. Practical chemical calculations involve very large numbers of atoms and molecules.

The equation weight in grams of a compound or element is defined as the gram molecular weight times the number of molecules of the compound, as shown by the coefficients of the chemical equation for the reaction. The sums of the equation weights on each side of a chemical equation must be equal. Chemical calculations are based on the fact that every fraction or multiple of the equation weights of substances that react gives a corresponding fraction or multiple of the equation weights of the products of the reaction. In other words, if 30 grams of a substance that has an equation weight of 15 grams reacts with some amount of another substance to form a product with an equation weight of 20 grams, then 40 grams of that product will be formed.

Example:

How many grams of ferric oxide will be formed if 27.9 grams of iron reacts with water according to the following equation.

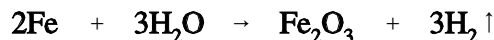

Solution:

The equation weight of iron equals the gram atomic weight of iron times the number of atoms shown reacting in the equation, which is two. Using Table 2:

$$\begin{aligned} \text{Equation Weight Fe} &= 2 \times 55.8 \text{ grams} \\ &= 111.6 \text{ grams} \end{aligned}$$

Because 27.9 g of iron react, the fraction of the equation weight that reacts is:

$$\frac{27.9 \text{ grams}}{111.6 \text{ grams}} = \frac{1}{4}$$

Thus, 1/4 of the equation weight of ferric oxide will be formed.

The equation weight of ferric oxide equals the gram molecular weight of ferric oxide times the number of molecules shown formed in the equation, which is one.

Using Table 2:

$$\begin{aligned} \text{Equation Weight Fe}_2\text{O}_3 &= 2(55.8 \text{ g}) + 3(16.0 \text{ g}) \\ &= 111.6 \text{ g} + 48.0 \text{ g} \\ &= 159.6 \text{ g} \end{aligned}$$

Thus, the amount of ferric oxide formed is:

$$\frac{1}{4} (159.6 \text{ g}) = 39.9 \text{ g}$$

## **Summary**

The important information from this chapter is summarized below.

### **Chemical Equations Summary**

- Le Chatelier's principle states that if a stress is applied to an equilibrium, the system will adjust to minimize the effect of the stress.
- The following terms are defined:
  - Density is the measure of the mass per unit volume of a material (density = mass/volume).
  - Molarity is moles of solute per liter of solution. Molar solutions are symbolized by the capital letter M.
  - Normality, (N), is defined as the number of equivalents of solute dissolved in one liter of solution.
  - ppm expresses the concentration of a solution in units of one part of solute to one million parts solvent. One ppm equals one milligram of solute per liter of solution.
- To balance chemical equations, the number of elemental constituents must be the same on each side of the equation.

---

## ACIDS, BASES, SALTS, AND pH

---

*Different substances respond differently in solution. How substances behave in water is of special interest to the power industry. The interactions of water and acids, bases, or salts are of special interest because water is used in many industries. This chapter will introduce the student to the general behavior of these substances.*

**EO 3.1      DEFINE the following terms:**

- |                                                                                                        |                                                                                                    |
|--------------------------------------------------------------------------------------------------------|----------------------------------------------------------------------------------------------------|
| <p><b>a.    Acid</b></p> <p><b>b.    Salt</b></p> <p><b>c.    pOH</b></p> <p><b>d.    Alkalies</b></p> | <p><b>e.    Base</b></p> <p><b>f.    pH</b></p> <p><b>g.    Dissociation constant of water</b></p> |
|--------------------------------------------------------------------------------------------------------|----------------------------------------------------------------------------------------------------|

**EO 3.2      STATE the formula for pH.**

**EO 3.3      STATE the formula for pOH.**

**EO 3.4      CALCULATE the pH of a specified solution.**

---

### Acids

Substances that form ions when they are dissolved in water are called electrolytes. The three types of electrolytes are acids, bases, and salts.

*Acids* are substances that dissociate in water to produce hydrogen ( $H^+$ ). An example of a common acid is sulfuric acid,  $H_2SO_4$ . In solution,  $H_2SO_4$  dissociates to form hydrogen and sulfate ions according to the following equation. The designation in parenthesis in the following formulas indicate the state of the reactants and the products, i.e., liquid (aq), solid (s), or gas (g).

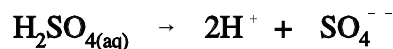

Additional examples of acids are vinegar, aspirin, and lemon juice. These substances share the following common properties.

1.    Acid solutions taste sour (acid means "sour" in Latin).
2.    Acids react with many metals to form hydrogen gas.

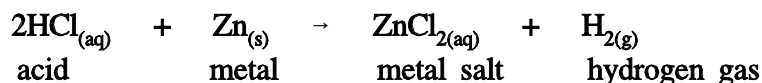

3. Acids turn litmus paper red.
4. Acid solutions conduct electricity.
5. Acids react with bases to form a salt and water.

Example:

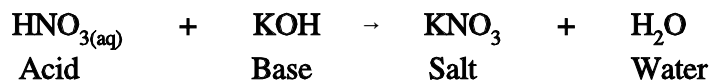

6. Acids react with carbonates to form CO<sub>2</sub> (carbon dioxide gas).

Example:

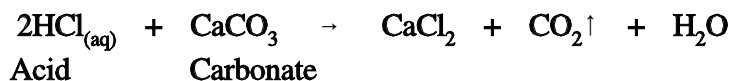

## **Bases**

*Bases* are substances that produce hydroxide ions (OH<sup>-</sup>) in water solutions. An example of a common base is sodium hydroxide, NaOH. In solution, it dissociates to form sodium ions and hydroxide ions according to the following equation:

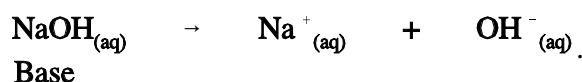

Common types of bases are lye, household ammonia, and most soaps. The following are four characteristic properties of bases.

1. Basic solutions taste bitter and feel slippery to the touch.
2. Bases turn litmus paper blue.
3. Basic solutions conduct electricity.
4. Bases neutralize acids.

Example:

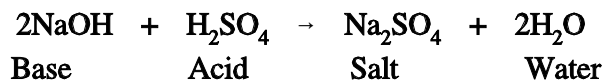

## **Salts**

When an acid reacts with a base, two products are formed; water and a salt. A *salt* is an ionic compound composed of positive ions and negative ions. The ionic bond is what keeps salts in their molecular form. Some compounds look like salts, but are actually covalent compounds (have a covalent bond).

Example:

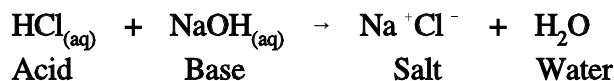

This type of acid-base reaction is called neutralization.

Certain soluble salts (principally sodium, potassium, magnesium, and calcium) that have the property of combining with acids to form neutral salts are called *alkalies*. Two of the common salts are sodium chloride (table salt) and calcium chloride (salt put on the road in winter). Unlike acids and bases, salts vary greatly in all their properties except their ionic characteristics. Salts may taste salty, sour, bitter, astringent, sweet, or tasteless. Solutions of salts may be acidic, basic, or neutral to acid-base indicators. Fused salts and aqueous solutions of salts conduct an electric current. The reactions of salts are numerous and varied.

## **pH**

Many compounds dissolve in water and alter the hydrogen ion concentration. Compounds that produce hydrogen ions directly when dissolved in water are called acids, and those that produce hydroxyl ions directly when dissolved in water are called bases. To treat these aspects of chemistry more precisely, a quantitative system of expressing acidity or basicity (alkalinity) is needed. This need could be met by using the value of  $[\text{H}^+]$ , where  $[\text{H}^+]$  is expressed in moles/liter, as a measure of acidity. But, in most cases  $[\text{H}^+]$  is in the range of  $10^{-10}$  to  $10^{-14}$  moles/liter. Because numbers of this magnitude are inconvenient to work with, an alternate system for expressing the acidity of dilute solutions has been devised. This system is based on a quantity called *pH*. *ph* is defined as the negative logarithm of the hydrogen concentration, represented as  $[\text{H}^+]$  in moles/liter.

$$\text{pH} = -\log [\text{H}^+] \quad (1-1)$$

$$[\text{H}^+] = 10^{-\text{pH}} \quad (1-2)$$

The negative logarithm is specified because the logarithm of any number less than 1 is negative; thus multiplication by -1 causes the values of pH to be positive over the range in which we are interested. (The term pH was first defined by a Danish chemist and is derived from p for the Danish word *potenz* (power) and H for hydrogen.)

Example 1: The hydrogen concentration,  $[H^+]$ , of a solution is  $4.8 \times 10^{-8}$  moles/liter. What is the pH of the solution?

Solution 1:

$$\begin{aligned} \text{pH} &= -\log [H^+] \\ &= -\log (4.8 \times 10^{-8}) \\ &= 7.32 \end{aligned}$$

Example 2: The pH of a solution is 3.83. What is the hydrogen concentration of the solution?

Solution 2:

$$\begin{aligned} [H^+] &= 10^{-\text{pH}} \\ &= 10^{-3.83} \text{ moles/liter} \\ &= 1.48 \times 10^{-4} \text{ moles/liter} \end{aligned}$$

## **pOH**

It is also important to understand the relationship between the  $[H^+]$  and the  $[OH^-]$  concentrations. The *pOH* of a solution is defined as the negative logarithm of the hydroxyl concentration, represented as  $[OH^-]$  in moles/liter.

$$\text{pOH} = -\log [OH^-] \quad (1-3)$$

$$[OH^-] = 10^{-\text{pOH}} \quad (1-4)$$

For water solutions, the product of the hydrogen ion concentration and the hydroxyl concentration is always  $1 \times 10^{-14}$  at  $25^\circ\text{C}$ . This means that the sum of pH and pOH is equal to 14 under these conditions.

$$[H^+] \times [OH^-] = 1 \times 10^{-14}$$

$$\text{pH} + \text{pOH} = 14$$

The following example illustrates this point.

Example: What is the hydrogen ion concentration  $[H^+]$  and the hydroxyl concentration  $[OH^-]$  in a solution with a pH of 5.5?

Solution:

$$\begin{aligned} [H^+] &= 10^{-\text{pH}} \\ &= 10^{-5.5} \\ &= (10^{-6}) (10^{-5}) \\ &= 3.16 \times 10^{-6} \text{ moles/liter} \end{aligned}$$

$$\begin{aligned} \text{since } \text{pOH} + \text{pH} &= 14 \\ \text{pOH} &= 14 - 5.5 \\ \text{pOH} &= 8.5 \end{aligned}$$

$$\begin{aligned} \text{and } [OH^-] &= 10^{-\text{pOH}} \\ &= 10^{-8.5} \\ &= (10^{-9}) (10^{-5}) \\ &= 3.16 \times 10^{-9} \text{ moles/liter} \end{aligned}$$

### **Dissociation Constant**

The product of ionic concentrations,  $K_w = [H^+][OH^-]$ , is called the Ion Product Constant for water, or more frequently, the Ionization Constant or *Dissociation Constant*. At 25°C,  $K_w$  equals  $1 \times 10^{-14}$ .  $K_w$  varies with temperature and, at 37°C (body temperature), the value is about  $3.4 \times 10^{-14}$ . Figure 17 illustrates the relationship of the Dissociation Constant with water temperature. As indicated earlier, a change in temperature causes a change in equilibrium in a chemical reaction. Because the ionization of water is an equilibrium process, it is also affected by temperature. The Dissociation (or Ionization) Constant,  $K_w$ , for water increases with increasing temperature up to about 500°F and then decreases. Experimental values of  $K_w$  at various temperatures are listed in Table 5 and graphed in Figure 16. Notice in Table 5 that the pH of pure water changes with temperature. For pure water at any temperature, however,  $[H^+] = [OH^-]$ . It should be noted that the equation  $\text{pH} + \text{pOH} = 14$  is true only at or near 25°C (77°F).



Example: The hydroxyl concentration  $[\text{OH}^-]$  of a water solution<sup>o</sup> at 25 C is  $7.2 \times 10^{-9}$  moles/liter. Calculate the pH of the solution.

Solution:

$$K_w = [\text{H}^+] [\text{OH}^-]$$

$$[\text{H}^+] = \frac{K_w}{[\text{OH}^-]}$$

$$= \frac{1 \times 10^{-14}}{7.2 \times 10^{-9}}$$

$$= 1.38 \times 10^{-6}$$

$$\text{pH} = -\log [\text{H}^+]$$

$$= -\log (1.38 \times 10^{-6})$$

$$= 5.86$$

Temperature		Ion Product Constant for Water	pH of Pure Water
F	C		
64.4	18	$0.64 \times 10^{-14}$	7.10
77	25	$1.0 \times 10^{-14}$	7.00
140	60	$8.9 \times 10^{-14}$	6.54
212	100	$6.1 \times 10^{-13}$	6.10
302	150	$2.2 \times 10^{-12}$	5.83
392	200	$5.0 \times 10^{-12}$	5.65
482	250	$6.6 \times 10^{-12}$	5.59
572	300	$6.4 \times 10^{-12}$	5.60
662	350	$4.7 \times 10^{-12}$	5.66

At 25°C, an equilibrium exists between pure molecular water and its ions. The  $[\text{H}^+]$  equals the  $[\text{OH}^-]$  and both have values of  $1 \times 10^{-7}$  moles/liter. Using the pH definition, it follows that the pH of pure water at 25°C is 7. pH values less than 7 indicate an acidic solution and values greater than 7 indicate a basic or alkaline solution.

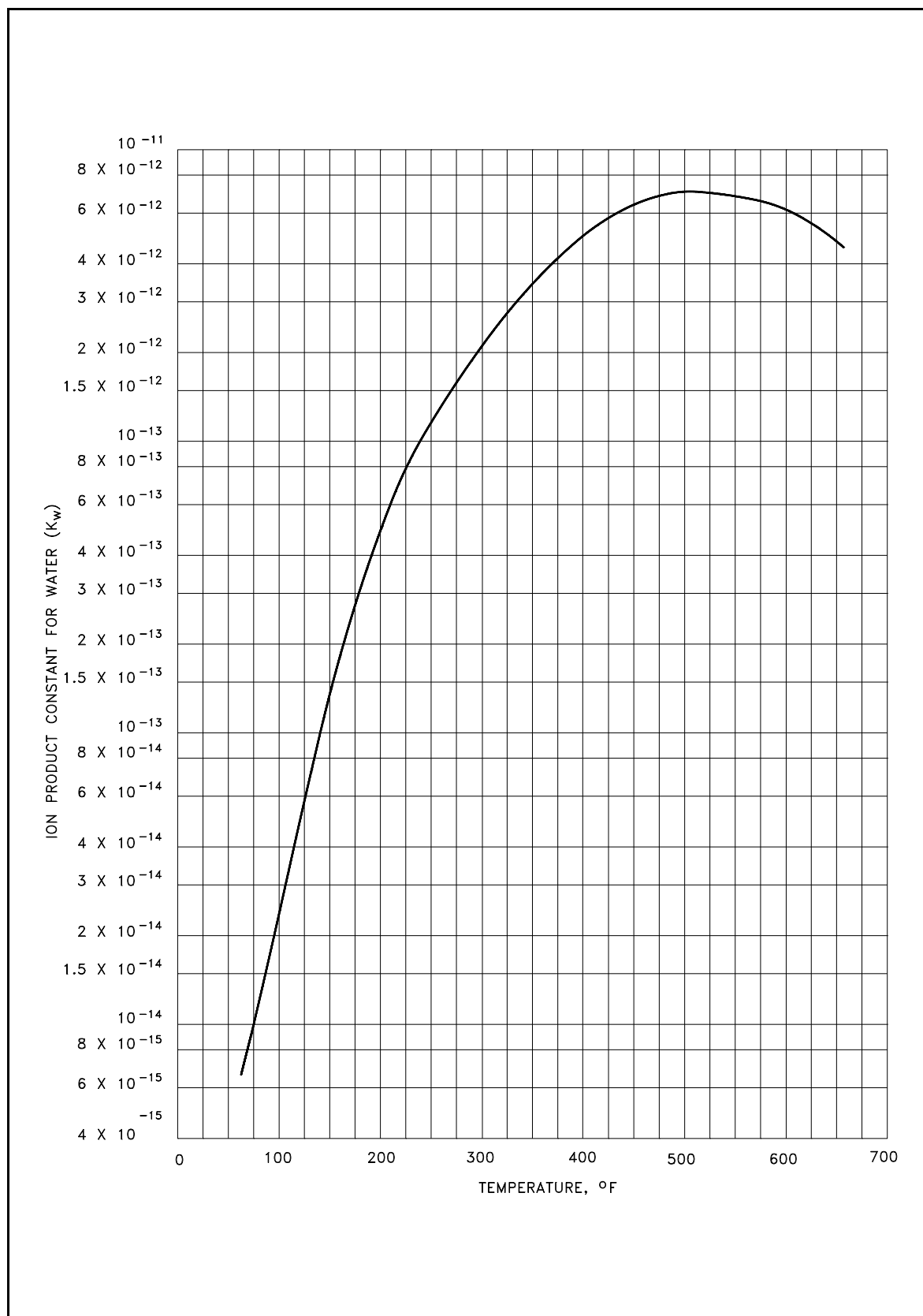

Figure 17 Ion Product Constant for Water

## **Summary**

The important information in this chapter is summarized below.

### **Acids, Bases, Salts, and pH Summary**

- The following terms are defined in this chapter:

Acid - substances that produce hydrogen ( $H^+$ ) in water solutions

Base - substances that produce hydroxide ions ( $OH^-$ ) in water solutions

Salt - a compound composed of positive and negative ions held together with an ionic bond

Alkalies - certain soluble salts, principally sodium, potassium, magnesium and calcium, that have the property of combining with acids to form neutral salts

pH - the negative logarithm of the hydrogen concentration [ $H^+$ ] in moles/liter

pOH - the negative logarithm of the hydroxyl concentration [ $OH^-$ ] in moles/liter

Dissociation constant of water ( $K_w$ ) - the product of ionic concentrations, ( $[H^+][OH^-]$ ); at  $25^\circ C$   $K_w = 1 \times 10^{-14}$

- The formula for pH is:  $pH = -\log [H^+]$   
Therefore,  $[H^+] = 10^{-pH}$
- The formula for pOH is:  $pOH = -\log [OH^-]$   
Therefore,  $[OH^-] = 10^{-pOH}$

Intentionally Left Blank.

**Department of Energy  
Fundamentals Handbook**

**PLANT CHEMISTRY**  
**Appendix A**  
**Basic Separation Theory**



## BASIC SEPARATION THEORY

---

### Introduction

The fundamental principles upon which a gaseous diffusion plant is based are as follows.

1. All the particles (atoms, molecules, or ions) which make up the gas are continuously moving in straight lines in all directions. The particles collide with anything in their path (e.g., other particles or the walls of the container), thereby altering the course of moving particles but not their average velocities.
2. All of the particles have the same average kinetic energy. Accordingly, if the masses of the particles are different, so must their velocities be different with the lighter particles having the greater average velocities.

On the basis of the two principles stated above, if a quantity of gas is confined by a porous membrane or barrier, some of the gas will escape through the pores in the barrier. If the confined gas is isotopic (a mixture of particles of different molecular weights), the lighter particles of the gas will have a greater tendency to diffuse through the barrier because of their greater average velocities. Consequently, the gas which has passed through the barrier will be enriched in the light constituent while that gas which has not diffused through the barrier will be depleted in the light constituent.

### Isotopic Separation

The isotopes with which we are concerned are those of uranium; namely  $U^{235}$  and  $U^{238}$ . In order that the isotopes of uranium may be separated by the gaseous diffusion process, it is necessary that the uranium be in a gaseous state. This is accomplished by combining the uranium with fluorine to form uranium hexafluoride, which is a gas at workable temperatures and pressures. Another advantageous quality of uranium hexafluoride is that fluorine has no isotopes to further complicate the separation process. In general, the following discussion is concerned with the separation of  $U^{235}F_6$  and  $U^{238}F_6$ .

## **Separation Factor**

The ability of a barrier to separate isotopes is expressed by a value called the *separation factor*. It is denoted by the Greek letter  $\alpha$ , and is defined as the mole ratio of light component to heavy component in the gas passing through the barrier at a given point divided by a similar mole ratio on the high pressure surface of the barrier at the same point. The separation factor can be expressed by the following equation.

$$\alpha = \frac{\frac{y}{1-y}}{\frac{x}{1-x}}$$

In this equation,  $y$  and  $x$  are the mol fraction of light component on the low and high pressure sides of the barrier respectively. It should be emphasized that  $\alpha$ , as shown in Figure A-1, is a point value, and that  $x$  and  $y$  are concentrations at a given point on the two surfaces of the barrier. In practice, point values are usually not determined. The average  $\alpha$ 's of the surface of samples are calculated from experimental separation data.

As previously stated, the separation of isotopes is dependent upon the difference in the mass of the particles. Under ideal conditions, the separation factor would be equal to the ratio of the square roots of the molecular weights. For a mixture of  $U^{235}F_6$  and  $U^{238}F_6$ , this value is 1.0043 and is commonly referred to as the ideal separation factor. In actual practice, however, these ideal conditions cannot be duplicated. For example, to approach the ideal separation factor, only a small fraction of the total gas involved could be diffused through the barrier. For such a process to be productive, the plant size and its power consumption would be too large to be economically feasible. Limitations of plant size and power consumption have, necessitated a reduction in the separation factor to a lower value. This lower value is called the actual separation factor.

## **Stage Separation**

The ratio of the total molar rate of flow through the barrier within a converter to the total rate of flow into the same converter is called the *cut* and is designated by the Greek letter  $\Theta$ .

$$\Theta = \frac{\text{Molar flow of enriched stream}}{\text{Molar flow of input stream}}$$

In a production cascade, a cut of approximately 0.5 is the optimum value with respect to operating efficiency and production.



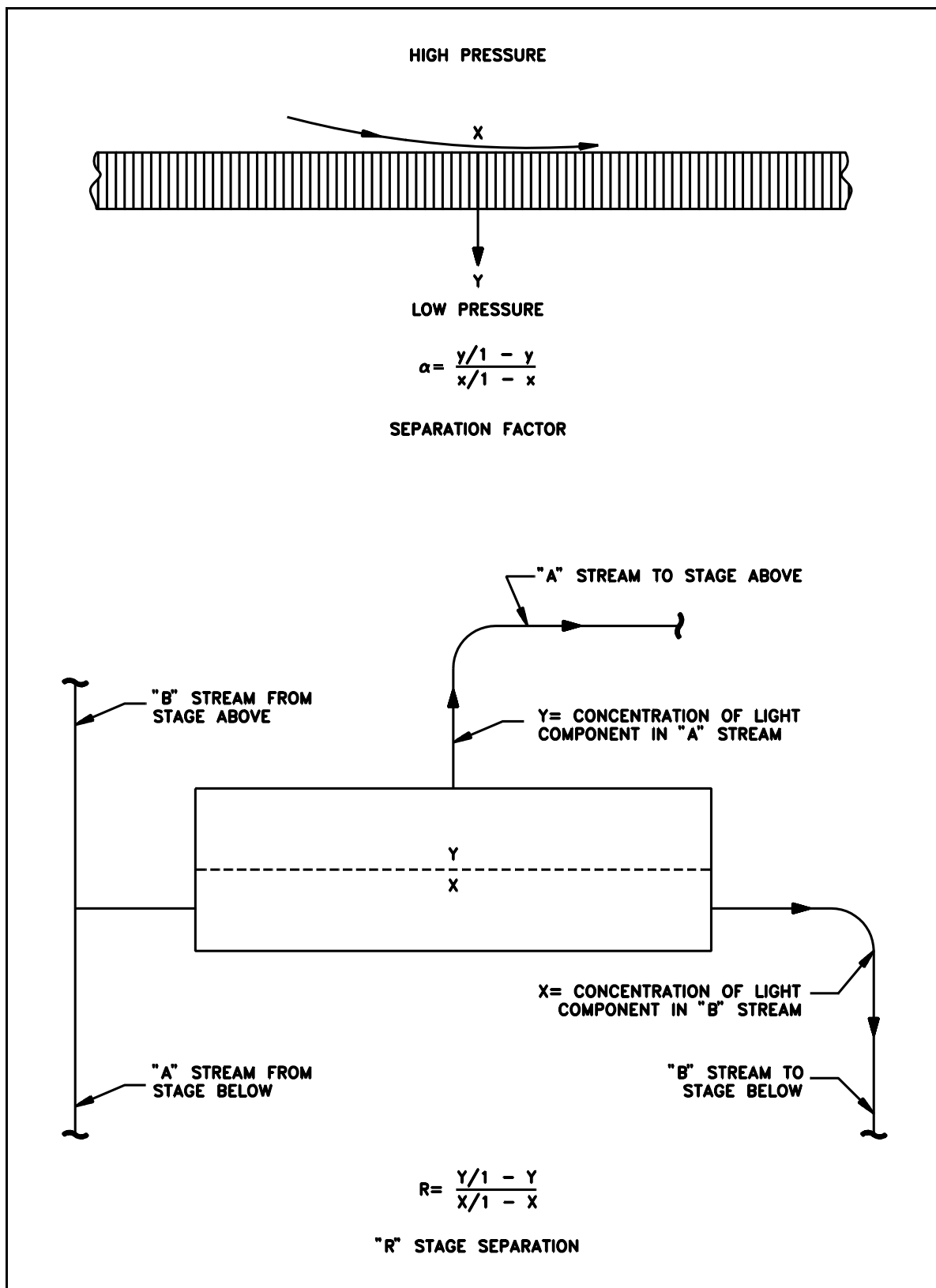

Figure A-1 "R" Stage Separation

The actual separation achieved by a stage is expressed in terms of the mol fraction of the light component and for the purpose of this discussion is designated by the capital letter R. It can be defined as follows: if Y is the concentration of light component in the enriched stream leaving a converter and X is its concentration in the depleted stream leaving the same converter, then

$$R = \frac{\frac{Y}{1 - Y}}{\frac{X}{1 - X}}$$

This definition is similar to that of the separation factor, but, as shown in Figure A-1, the value of R is based on the overall separation of a stage while that of the separation factor is based on the performance of the barrier alone. The relation between the two is given by the following equation.

$$R = E \alpha \frac{1}{\Theta} \ln \frac{1}{1 - \Theta}$$

E is a correction factor called the *mixing efficiency*. It can be explained as follows: since the light component passes through the barrier more rapidly than the heavy component, the layer of gas at the surface on the high pressure side of the barrier becomes more depleted in the light component than the bulk of the gas on the high pressure side. Thus, there is a concentration gradient perpendicular to the surface of the barrier which results in a decrease in separation. In the particular process of separation of uranium isotopes, the value of R in the preceding equation differs very little from unity ( $R = 1.003$ ) and is somewhat inconvenient for use in calculations. By subtracting 1 from each side of the equation, equating the symbol  $\psi$  (psi) to  $R - 1$ , and by making a slight approximation, the equation becomes

$$\psi = \frac{Y - X}{X(1 - X)}$$

This equation is used frequently in the plant in making separation tests.

## **Barrier Measurements**

The ability of a barrier to transmit gas is usually expressed as  $\gamma$  (gamma), the *permeability*. This is a measure of the total flow through a barrier and may be defined as the ratio of the number of molecules which pass through the barrier to the number which would pass through the space if the barrier were not there. This total flow through a barrier is known to be a combination of several different types; namely, diffusive flow, film flow, and viscous flow. As was previously explained, the type of flow that is of greatest importance for a gaseous diffusion plant is diffusive flow. However, as film flow and viscous flow affect the separation through a barrier, they cannot be ignored.

*Film flow* refers to the transport of molecules under the influence of the force field between the molecules and the barrier surface. When such force fields are significant, a large number of molecules will not have sufficient velocity normal to the surface to escape from this field so that their motion will be confined to the barrier surface and barrier pore surface. Such molecules would pass through the barrier as a film on the surface of the pores.

*Viscous flow* occurs when molecules flow as a group in the manner of ordinary flow through a tube. Referring back to permeability, it is known that the flow through a barrier increases as the pressure increases. Also, as the pressure increases, so does the viscous component of flow. The relation between permeability and viscous flow can best be shown by the following equation.

$$\gamma = \gamma_o [1 + S(P_f + P_b)]$$

In this equation where  $P_f$  equals the fore or high side pressure and  $P_b$  equals the back or low side pressure.  $\gamma_o$  equals the permeability,  $\gamma$ , when

$$P_f + P_b = 0.$$

$S$  is called the slope factor and is inversely proportional to the viscosity of the gas.

In the above equation, the term  $S(P_f + P_b)$  is a measure of the viscous component of flow. Figure A-2 illustrates the variation of permeability with the slope factor and changes in pressure.

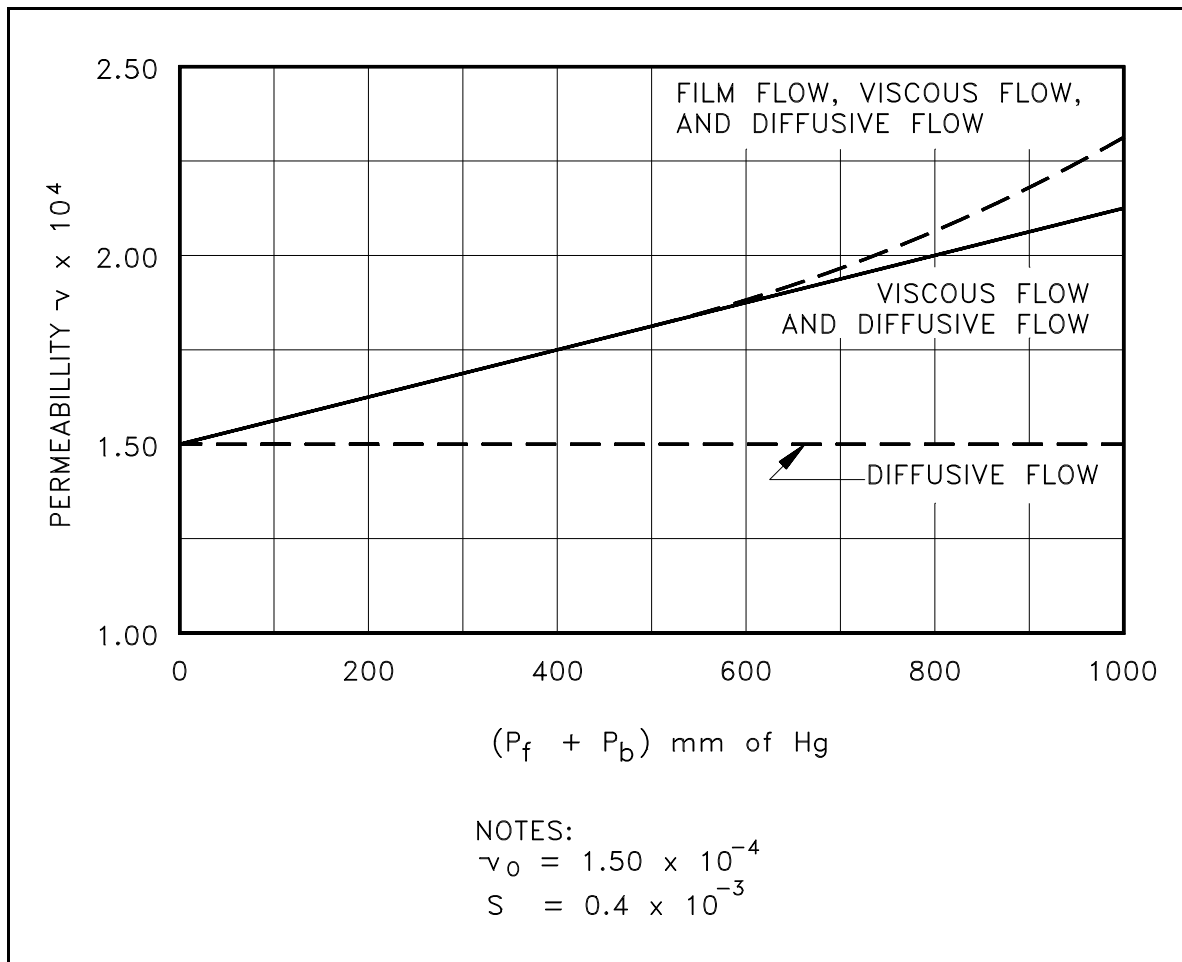

Figure A-2  
 Variation of Permeability with the Slope Factor and Change in Pressure

It should be noted that in practice, permeability is expressed in two different ways; design and actual. Design permeability is expressed as a ratio as previously stated. It is usually determined by testing the barrier with a non-toxic gas such as nitrogen. Actual permeability is expressed as a percentage of the design permeability and is determined from tests with the barrier in actual operation in the cascade. Its primary value is in determining the performance of a barrier after being in use for a period of time.

## **Cascade Theory**

In the operation of a diffusion cascade, it is often necessary to charge the plant with feed material of different assays or concentrations of  $U^{235}F_6$ . This feed must be fed into the cascade at a point where the assay of the gas already being processed is the same as that of the feed to be charged.

To choose this feed point, therefore, it must be possible to calculate the concentration of  $U^{235}F_6$  in the process gas at any point in the cascade. These calculations can be made by knowing two things: first, the concentration of  $U^{235}F_6$  in the process gas at several points in the cascade (determined by laboratory and instrument analysis); and second, the increase in the concentration of  $U^{235}F_6$  accomplished by each stage. This is called the stage enrichment and should not be confused with the separation accomplished by a stage previously discussed. Therefore, by knowing the stage enrichment and the  $U^{235}F_6$  concentration at some point in the cascade, it is possible to determine the concentration at other points.

The feed material ordinarily charged into a plant contains a very small percentage of  $U^{235}F_6$  with the remainder being  $U^{238}F_6$ . Consequently, a far greater amount of the feed flows downward in the cascade and is removed as tails than is removed at the top of the cascade as  $U^{235}F_6$  or product. For this reason, as we progress upward in the cascade from the feed point, the total flow through the converters becomes progressively smaller. It follows, therefore, that in the ideal design each stage would be different in size from the adjacent stages. However, since the cost of construction of a production cascade is of great importance, a lower cost may be achieved by the use of many identical units. For this reason, the cascade is composed of a series of sections, each of which contains a large number of identical stages. The change in equipment size is accomplished in a step-wise manner by varying the equipment size of each so-called section.

### **Circuit Balances**

Of major importance in a production cascade is the ability to calculate pressures, temperatures, and flows of the process gas which cannot be practically or economically measured by instrumentation. Since the cascade is made up of sections each of which contains a large number of identical stages and since the stage is the smallest separating unit of a cascade, these calculations are made on a stage basis. This system of calculating temperatures, pressures, and flows is commonly referred to as a circuit balance and consists of a series of calculations made from those pressures and temperatures ordinarily measured by instrumentation in the cascade, and from experimental data obtained from test loop studies.

For illustration purposes, the pressures, temperatures, and flows in a typical X-31 stage which are taken by instrumentation, plus those to be calculated, are shown in Figure A-3. It is obvious that the cost to install instruments in every stage to measure all of the values indicated would be prohibitive.

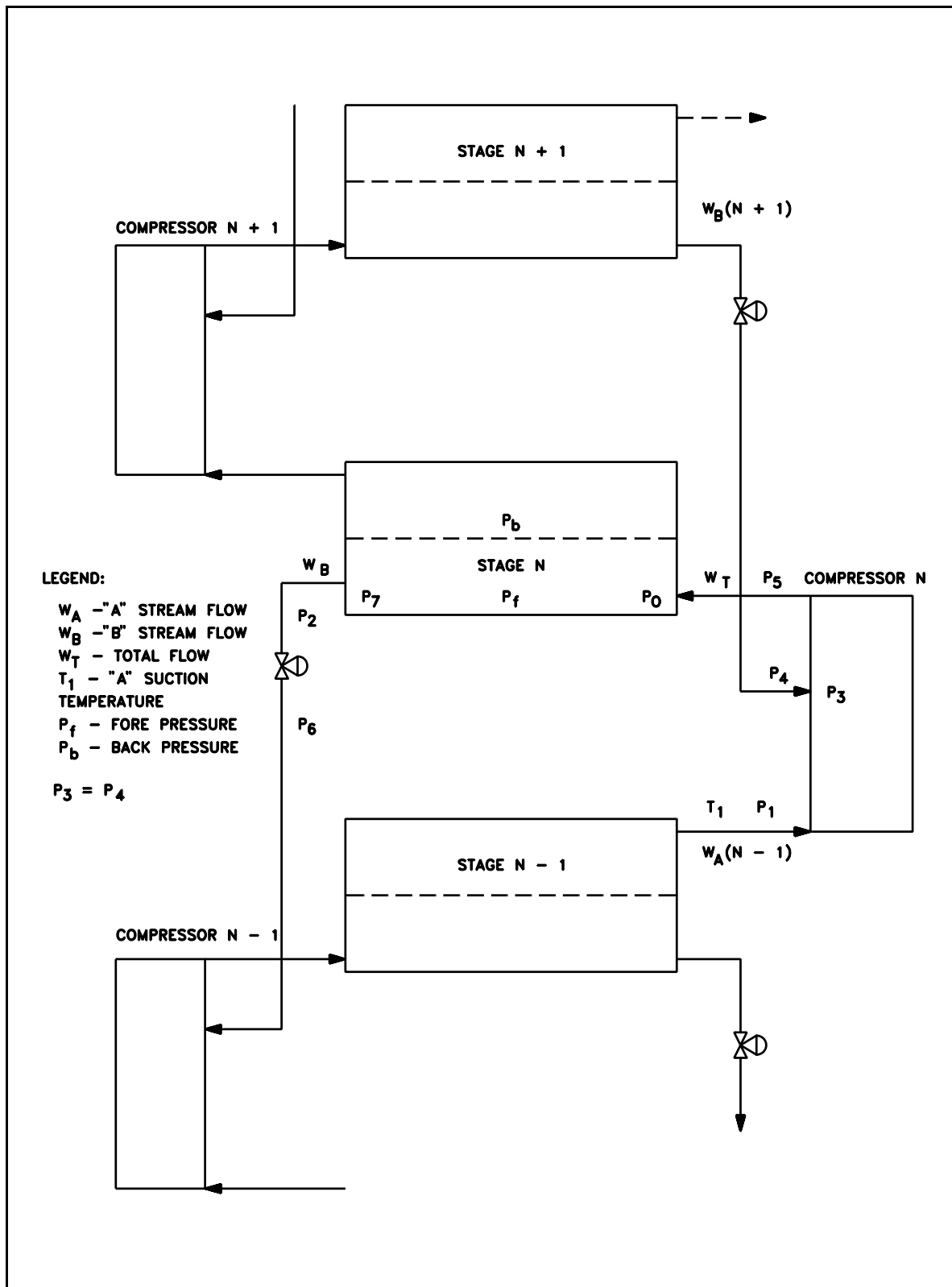

Figure A-3  
Pressures, Temperatures, and Flows in a Typical V-31 Stage

Because of their number and complexity, the mathematical formulas used in calculating the pressure points in Figure A-3 will not be presented. The operator will read and record only those values which are measured by instruments and will not be required to perform any of the mathematical calculations involved in completing a circuit balance. However, the following discussion will give an indication as to the procedures involved in determining these values. To calculate a circuit balance for Stage N in Figure A-3, pressures  $P_1$  and  $P_2$  and temperature  $T_1$  are recorded. Then, knowing  $P_1$  and  $T_1$  and a constant previously determined in a test loop, it is possible to calculate the flow  $W_A(N - 1)$ . Since the "A" barrel of the compressor has essentially a constant suction volume in the normal operating range, the interstage flow is proportional to the compressor "A" suction pressure and temperature. Next, it is known that the flow in a cascade must operate at a steady state condition to prevent an accumulation of deficiency of inventory in any one section. It may therefore be assumed that the flow downward to a stage is equal to the flow upward from the same stage. (This assumption is not valid for all stages in a cascade but for practical applications the error is negligible.) From this assumption,  $W_B$  is equal to  $W_A(N - 1)$ . With  $P_2$ ,  $W_B$ , and pressure drop data obtained in the test loop,  $P_7$  can be calculated.

In a test loop, data is taken on converters of different sizes and types to determine pressure variations with different amounts of flow and cut. If  $W_A$  is found in the same manner as  $W_A(N - 1)$ , it is then possible with the test loop data to calculate  $P_b$ . Also, with the converter data, and knowing  $W_B$ ,  $P_7$ , and  $W_T$  ( $W_T = W_A + W_B$ ),  $P_o$  and subsequently,  $P_f$  are found.

Again using pressure drop data,  $P_5$  can be calculated from  $W_T$  and  $P_o$ . With  $P_5$ ,  $P_3$  is calculated by knowing the "B" pressure ratio of the compressor.

From the calculated values obtained from a circuit balance, it is possible to make further calculations which indicate the operational and productive characteristics of the cascade. For example,  $P_f$ ,  $P_b$ , and the flows through a converter must be known before the actual permeability of the barrier can be calculated. Also, these values make it possible to accurately predict horsepower requirements under varying conditions of flow and pressure. Another important application of the circuit balance is in the determination of inventory in the cascade where pressures and temperatures not otherwise measured are required.

## CONVERTERS

### Converters

The actual separation of  $U^{235}F_6$  from  $U^{238}F_6$  in a gaseous diffusion plant is accomplished in the converter. The converter, sometimes referred to as a diffuser, contains the barrier tubing through which diffusion takes place. In the previous section we studied the flow through the converter as a part of a stage. In this section we will see what takes place inside the converter.

In all, the entire cascade contains over 4000 converters -- one in each stage. The stage size varies with the location in the cascade as shown in the table below.

Equipment Type	Converter Type	Length (inches)	Diameter (inches)	Number Used In Cascade
33	000	291	155	640
31	00-2	221	105	500
29	0	185 or 215	90 or 105	600
27	7	129	47	720
25	8	129	38	1560

### Converter Construction

Externally, the converter resembles a large cylindrical tank resting on its side (see Figure A-4). There are openings at each end for the necessary piping connections. The outlet end of the converter contains the "A" and "B" stream process gas outlets. The other end contains the mixed process gas inlet and the stage coolant inlet and outlet. The cylindrical tank is called the shell and is constructed of steel with welded joints. Its internal surface is nickel plated. There are three external reinforcing flanges around the outside of the shell. The many hundreds of barrier tubes, or tube bundles, contained in one converter are held in place by the spool, or spool piece. The spool consists of struts and a central tube, or core, which is perforated and allows part of the "A" stream leaving the barrier tubes to reach the converter outlet. On either end of the core are tube sheets into the holes of which the barrier tubes are sealed by rolling or swagging. Tube sheets are also mounted on the core between the end tube sheets to support the barrier tubes.



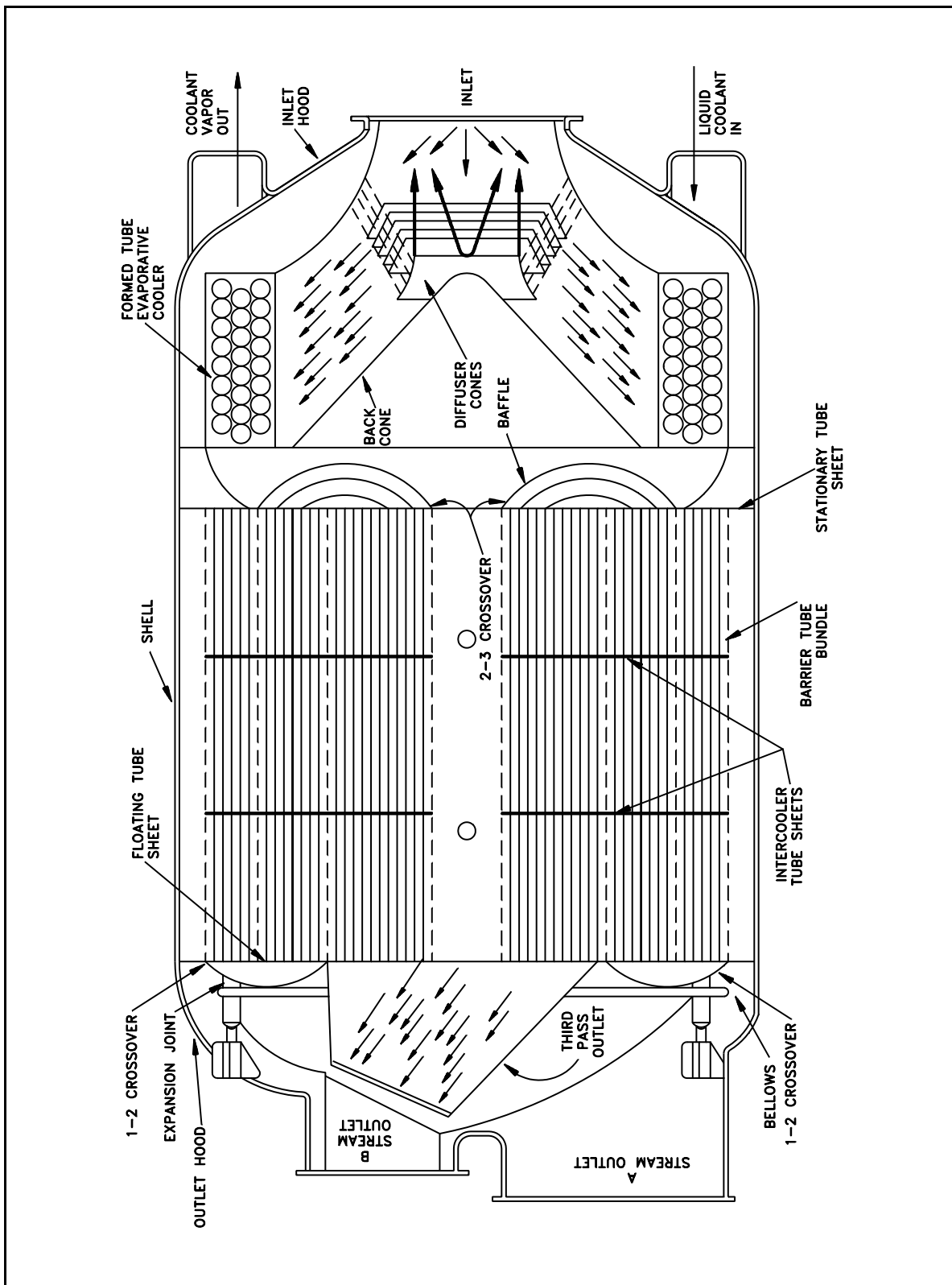

Figure A-4 - Typical Converter

The remainder of the converter equipment, with the exception of the gas cooler, is designed to direct the process gas flow inside the converter.

## **The Gas Cooler**

The gas cooler's purpose is to remove the heat of compression from the process gas which has just been discharged from a compressor. Certain type of stages use a gas cooler contained within the converter as shown on Figure A-4. The gas coolers may be separate units placed between the compressors and the converters.

## **Barrier Tubing**

In the early stages of converter design, it was recognized that barriers made in the form of flat sheets and stacked in a container would offer the most barrier area per unit volume. For practical reasons, the barrier had to be made in the form of tubes. More engineering knowledge was available for tubular construction and the urgency of the problem did not allow any unnecessary development time. The use of tubes also allowed more satisfactory replacement of damaged barrier material. As a result, the barrier is made in the form of thin-walled tubes.

## **Process Gas Flow**

We can now trace the process gas flow within the converter. In the AB cooled converter of Figure A-4, the process gas enters one end of the converter at the center and is directed to the outside of the shell by a series of baffles. It flows through the gas cooler and is directed to the outer section, or pass, of the barrier tubes. All of the flow enters the outer, or first pass, and flows through the tubes. Part of the flow diffuses through the barrier tube walls and the remainder of the flow passes through the tubes and is directed by a crossover to the second pass of tubes. This crossover is sometimes called a doughnut because of its shape. The process gas flow which does not diffuse through the barrier tube walls of the second pass is directed by a second crossover to the third pass. The first crossover is sometimes referred to as the 1-2 crossover because it directs gas flow from the first pass to the second pass. Similarly, the second crossover is called the 2-3 crossover. The undiffused process gas which passes through the third pass is directed to the "B" outlet of the converter and flows to the stage below. The process gas which was diffused through the barrier tubes in all three passes is collected and flows to the "A" outlet and on to the stage above.

Since some of the process gas flowing into the first pass will diffuse through the tube walls, a reduced amount of process gas flow will enter the second pass. In order to maintain the same flow velocity, the second pass contains fewer tubes than the first pass. Similarly, the third pass will contain still fewer tubes. The velocity of process gas through the tubes affects the flow through the tube walls and thus affects the separation efficiency. The efficiency is highest when the flow velocity is the same in all of the tubes.

In the Badger stage, about 50% of the process gas entering a converter diffuses through the tubing and flows to the stage above. This fraction is called the "cut." A cut of 50% has been found to yield the best separation. As mentioned previously, the "cut" in a Badger Cluster stage may be more or less than 50% depending upon its position in the cluster.

### **Diffusion**

It is necessary to have a higher pressure inside the barrier tubes than outside in order to have a flow through the walls of the tubes. This inside pressure is called the fore pressure or high side pressure (H.S.P.), and is measured at an arbitrary point inside the tubes near the middle of the second pass. The pressure outside the tubes is the back pressure or low side pressure (L.S.P.), and is measured at an arbitrary point outside the tubes near the middle of the second pass.

The fore pressure is regulated by a control valve in the "B" stream, or down flow, from the converter. Actually, the control valve regulates the pressure immediately above it. This is called the control pressure and is the pressure which is indicated at the cell panel. It is slightly lower than the fore pressure due to the pressure drops in the converter and piping.

The rate of diffusion through the tubing walls for any given pressure drop across the barrier is determined by the permeability of the barrier. Mathematically, this is a dimensionless quantity which is the ratio of the rate of gas flow through the barrier to the rate of gas flow through the same area which would take place if the barrier were not there. The term, usually called permeability, is used to relate the actual permeability to the design permeability. For example, if the flow through the barrier has decreased 10% due to plugging of the barrier holes, the permeability would be 90%.

Intentionally Left Blank

**Department of Energy  
Fundamentals Handbook**

**CHEMISTRY  
Module 2  
Corrosion**



---

## TABLE OF CONTENTS

---

LIST OF FIGURES .....	ii
LIST OF TABLES .....	iii
REFERENCES .....	iv
OBJECTIVES .....	v
CORROSION THEORY .....	1
Corrosion .....	1
Electrochemical Cells .....	3
Oxidation-Reduction Reactions .....	5
Passivity and Polarization of Metal .....	6
Summary .....	9
GENERAL CORROSION .....	11
Conditions Contributing to General Corrosion .....	11
Corrosion of Iron .....	12
Factors Affecting General Corrosion Rate .....	13
Prevention Chemistry Control .....	16
Corrosion of Aluminum .....	17
Summary .....	20
CRUD AND GALVANIC CORROSION .....	22
Crud .....	22
Galvanic Corrosion .....	23
Prevention of Galvanic Corrosion .....	24
Summary .....	25
SPECIALIZED CORROSION .....	27
Pitting and Crevice Corrosion .....	27
Stress Corrosion Cracking .....	31
Summary .....	36

---

**LIST OF FIGURES**

---

Figure 1	Formation of Ferrous ( $\text{Fe}^{++}$ ) Ions in the Corrosion of Iron	3
Figure 2	Metal Surface Showing Arrangement of Micro-cells	5
Figure 3	A Galvanic Cell	7
Figure 4	A Galvanic Cell Showing Absorbed Hydrogen Atoms on a Cathode	8
Figure 5	Simplified Schematic Diagram of Oxide Corrosion Film on the Surface of a Metal	13
Figure 6	Representation of Cathodic Depolarization by Oxygen	14
Figure 7	Effect of pH on the Corrosion Rate of Iron in Water	15
Figure 8	Effect of pH on the Relative Attack Rate of Iron in Water	15
Figure 9	Effect of pH on Aluminum Corrosion and Oxide Solubility	19
Figure 10	Galvanic Corrosion at Iron-Copper Pipe Junction	24
Figure 11	Differential Aeration Cell	28
Figure 12	Representation of Crevice Pitting	29
Figure 13	Pit in Metal Surface Promoted by Depolarization	30
Figure 14	Intergranular Corrosion Cracking	33
Figure 15	Austenitic Stainless Steel	34



---

## **LIST OF TABLES**

---

Table 1 Electromotive - Force Series (77°F) ..... 4

---

## REFERENCES

---

- Academic Program for Nuclear Plant Personnel, Volume II, Columbia, MD, General Physics Corporation, Library of Congress Card #A 326517, 1972.
- Dickerson, Gray, Darensbourg and Darensbourg, Chemical Principles, 4th Edition, The Benjamin Cummings Publishing Company, 1984.
- R. A. Day, Jr. and R. C. Johnson, General Chemistry, Prentice Hall, Inc., 1974.
- Glasstone and Sesonske, Nuclear Reactor Engineering, 3rd Edition, Van Nostrand Reinhold Company, 1981.
- Sienko and Plane, Chemical Principles and Properties, 2nd Edition, McGraw and Hill, 1974.
- Underwood, Chemistry for Colleges and Schools, 2nd Edition, Edward Arnold, Ltd., 1967.

---

## TERMINAL OBJECTIVE

---

- 1.0 Without references, **DESCRIBE** the causes and effects of corrosion on metals and the type of chemistry used in a plant to minimize corrosion.

---

## ENABLING OBJECTIVES

---

- 1.1 **DEFINE** the following terms:
- a. Ionization
  - b. Conductivity
  - c. Corrosion
  - d. Electrolysis
  - e. General corrosion
- 1.2 **DESCRIBE** an electrochemical cell with respect to the corrosion of metals.
- 1.3 **STATE** what happens to a metal during the oxidation step of the oxidation-reduction process.
- 1.4 **STATE** what happens to a metal during the reduction step of the oxidation-reduction process.
- 1.5 **DEFINE** the following terms:
- a. Passivity
  - b. Polarization
- 1.6 **DESCRIBE** the affects of passivity and polarization on the corrosion process.
- 1.7 **LIST** the two conditions that contribute to general corrosion.
- 1.8 **DESCRIBE** how the rate of corrosion occurring in the plant is affected by the following:
- a. Temperature
  - b. Water velocity
  - c. Oxygen
  - d. pH
  - e. Condition and composition of the metal surface

---

**ENABLING OBJECTIVES (Cont.)**

---

- 1.9 **LIST** the three products that are formed from the general corrosion of iron.
- 1.10 **IDENTIFY** the action taken for initial fill of a reactor system to limit general corrosion.
- 1.11 **STATE** the four methods used to chemically control general plant corrosion.
- 1.12 **LIST** the six water chemistry conditions that limit corrosion of aluminum.
- 1.13 **DEFINE** the following terms:
- a. Crud
  - b. Scale
  - c. Galvanic corrosion
- 1.14 **IDENTIFY** the five problems associated with the presence or release of crud into reactor coolant.
- 1.15 **STATE** the four causes of crud bursts.
- 1.16 **STATE** the two conditions that can cause galvanic corrosion.
- 1.17 **EXPLAIN** the mechanism for galvanic corrosion.
- 1.18 **IDENTIFY** the two locations that are susceptible to galvanic corrosion.
- 1.19 **STATE** the five control measures used to minimize galvanic corrosion.
- 1.20 **DEFINE** the following terms:
- a. Pitting corrosion
  - b. Crevice corrosion
  - c. Stress corrosion cracking
- 1.21 **STATE** the two conditions necessary for pitting corrosion to occur.
- 1.22 **STATE** the particular hazard associated with pitting corrosion.
- 1.23 **STATE** the four controls used to minimize pitting corrosion.

---

## **ENABLING OBJECTIVES (Cont.)**

---

- 1.24 **IDENTIFY** the three conditions necessary for stress corrosion cracking to occur.
- 1.25 **DEFINE** the term chemisorption.
- 1.26 **STATE** the hazard of stress corrosion cracking.
- 1.27 **STATE** the three controls used to prevent stress corrosion cracking.
- 1.28 **DESCRIBE** the two types of stress corrosion cracking that are of major concern to nuclear facilities including:
  - a. Conditions for occurrence
  - b. Method(s) used to minimize the probability of occurrence

Intentionally Left Blank.

---

## CORROSION THEORY

---

*Uncontrolled corrosion in DOE facilities can cause many serious problems. Corrosion occurs continuously, and every metal in every facility is subject to some type of corrosion. Even though corrosion cannot be eliminated, it can be controlled.*

**EO 1.1 DEFINE the following terms:**

- a. **Ionization**
- b. **Conductivity**
- c. **Corrosion**
- d. **Electrolysis**
- e. **General corrosion**

**EO 1.2 DESCRIBE an electrochemical cell with respect to the corrosion of metals.**

**EO 1.3 STATE what happens to a metal during the oxidation step of the oxidation-reduction process.**

**EO 1.4 STATE what happens to a metal during the reduction step of the oxidation-reduction process.**

**EO 1.5 DEFINE the following terms:**

- a. **Passivity**
- b. **Polarization**

**EO 1.6 DESCRIBE the affects of passivity and polarization on the corrosion process.**

---

### **Corrosion**

In DOE facilities, especially reactor plants, many precautions are taken to control the corrosion of metals used in the various primary and secondary systems. Uncontrolled corrosion of the reactor systems is detrimental for the following reasons.

- Rapid localized corrosion may lead to penetration of the metal containing the coolant. Radioactive coolant would then leak from the system and jeopardize safe operation.

- Corrosion of the nuclear fuel cladding may cause the cladding to become brittle and less ductile. The swelling from the generation of fission gases within the fuel may then cause the cladding to crack or blister, and highly radioactive fission products may then be released to the coolant.
- Some of the metallic oxide corrosion products released to the coolant may be deposited on surfaces in the reactor core. The neutron flux in the core produces nuclear reactions in the corrosion products, and they become highly radioactive. Subsequently, these activated corrosion products may be released from the core and redeposited on surfaces outside the core region. The radiation fields resulting from this redeposited material may then significantly increase radiation levels, thereby complicating maintenance and access capabilities. The corrosion product oxides may also result in fouling of heat transfer surfaces and in the accelerated wear of moving parts by corrosion products trapped in or between them.

*Current* is the flow of electrons through a medium. An electric current can flow through a metal conductor, and the metal will not show any obvious chemical changes. This type of conduction of electricity is called metallic conduction.

*Ionization* is the process of adding electrons to or removing electrons from atoms or molecules, creating ions. High temperatures, electrical discharges, and nuclear radiation can cause ionization. Many metals have a tendency to lose electrons to atoms or ions that have a tendency to gain electrons. Current can be conducted by the movement of these ions. The compounds that conduct electric current by ion movement are called electrolytes, and this ionic motion is called electrolytic conduction. *Conductivity* is a measure of the ability of a substance to allow electron flow. In the context of corrosion, conductivity indicates the amount of ions in solution, which relates directly to the potential of corrosion taking place.

*Corrosion* is the deterioration of a material due to interaction with its environment. Corrosion can have many forms, both wet and dry. *Electrolysis* is the decomposition by electric current (in the context of corrosion the use of electrical current to bring about chemical change). This chapter will concentrate on the corrosion of metals in water-based environments (electrolytes). An electrolyte is defined as an electricity-conducting fluid; that is, it has positive and negative ions that can move and constitute an electrical current. Pure water has a limited number of dissociated  $H^+$  and  $OH^-$  ions and is a relatively poor conductor of electricity. Addition of acids, bases, or salts that dissociate into ions increases the current-carrying capability of the water (electrolyte).



## Electrochemical Cells

Corrosion is electrochemical in nature because the corrosive chemical reactions involve transfer of charge. Figure 1 shows the transfer of charge when iron is in contact with water or an acidic water solution.

Iron goes into solution as  $\text{Fe}^{++}$  ions. As these ions go into solution, the metal becomes negatively charged (by the electrons left behind) with respect to the electrolyte. A potential difference (voltage) is produced between the electrolyte and the metal. The process in which electrons are given up and positive metal ions are formed is called oxidation. The sites at which the oxidation takes place on the surface of the metal become electrochemical cells made up of micro-electrodes of the two different substances; the metal and the electrolyte.

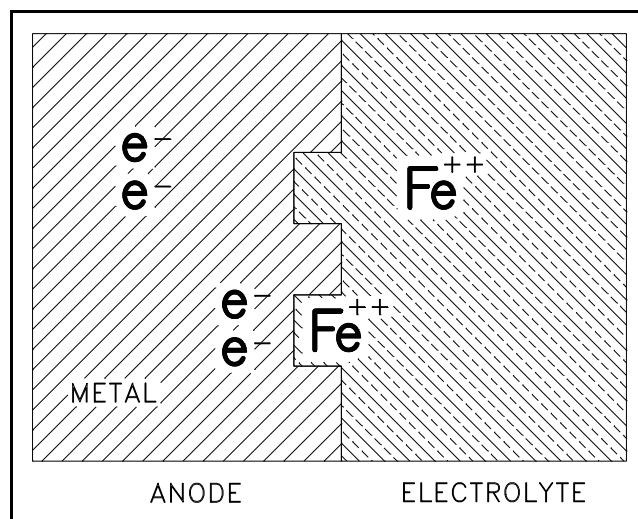

Figure 1 Formation of Ferrous ( $\text{Fe}^{++}$ ) Ions in the Corrosion of Iron

These micro-electrodes set up many micro-cells connected through the bulk of the metal. If a different metal is used, it will go into solution to a greater (or lesser) extent producing a larger (or smaller) potential difference between the metal and electrolyte than was the case for iron. For example, magnesium and zinc go into solution to a greater extent than iron, and these metals will be more negative with respect to the electrolyte than iron. Nickel, lead, and copper go into solution less readily and produce a smaller potential difference. Table 1 lists the potential differences for various metals in water. The order of the series can change for different electrolytes (for example, different pH, ions in solution).

Electrochemical cells and oxidation potentials are very important in understanding most corrosion processes. Examples of electrochemical cells include galvanic cells (cells made up of electrodes of two different substances) and concentration cells (cells containing electrodes of the same substance under different conditions of concentration).

**TABLE 1**  
**Electromotive - Force Series (77°F)**

Element	Electrode Reaction	Standard Electrode Potential, v
Sodium	$\text{Na} \rightarrow \text{Na}^+ + \text{e}$	-2.712
Magnesium	$\text{Mg} \rightarrow \text{Mg}^{++} + 2\text{e}$	-2.34
Beryllium	$\text{Be} \rightarrow \text{Be}^{++} + 2\text{e}$	-1.70
Aluminum	$\text{Al} \rightarrow \text{Al}^{+++} + 3\text{e}$	-1.67
Manganese	$\text{Mn} \rightarrow \text{Mn}^{++} + 2\text{e}$	-1.05
Zinc	$\text{Zn} \rightarrow \text{Zn}^{++} + 2\text{e}$	-0.762
Chromium	$\text{Cr} \rightarrow \text{Cr}^{+++} + 3\text{e}$	-0.71
Iron	$\text{Fe} \rightarrow \text{Fe}^{+++} + 3\text{e}$	-0.44
Cadmium	$\text{Cd} \rightarrow \text{Cd}^{++} + 2\text{e}$	-0.402
Cobalt	$\text{Co} \rightarrow \text{Co}^{++} + 2\text{e}$	-0.277
Nickel	$\text{Ni} \rightarrow \text{Ni}^{++} + 2\text{e}$	-2.250
Tin	$\text{Sn} \rightarrow \text{Sn}^{++} + 2\text{e}$	-0.136
Lead	$\text{Pb} \rightarrow \text{Pb}^{++} + 2\text{e}$	-0.126
Hydrogen	$\text{H} \rightarrow 2\text{H}^+ + 2\text{e}$	0.000 (reference)
Copper	$\text{Cu} \rightarrow \text{Cu}^{++} + 2\text{e}$	+0.345
Copper	$\text{Cu} \rightarrow \text{Cu}^+ + \text{e}$	+0.522
Silver	$\text{Ag} \rightarrow \text{Ag}^+ + \text{e}$	+0.800
Platinum	$\text{Pt} \rightarrow \text{Pt}^{++} + 2\text{e}$	+1.2
Gold	$\text{Au} \rightarrow \text{Au}^{+++} + 3\text{e}$	+1.42

The surface of any metal is a composite of a very large number of micro-electrodes, as illustrated in Figure 2. In order for corrosion to occur, the micro-cells must also be connected through some conducting path external to the metal. Usually the external connection is provided by water or an aqueous solution and the cells produce a current, allowing the chemical reactions responsible for corrosion to proceed.

Consider iron in water again. If the surface of the iron and the water solution were uniform, iron would go into solution as  $\text{Fe}^{++}$  ions until the difference in potential between the positively-charged solution and the negatively-charged metal stopped the iron ions from leaving the surface. In practice, though, impurities and imperfections (for example, oxide coatings) lead to preferential removal of metal from certain parts of the surface, and potential differences arise as in the two metal system. The corrosion cells, changing as surface and solution differences change, cause general overall corrosion. If the cells do not shift, pitting results.

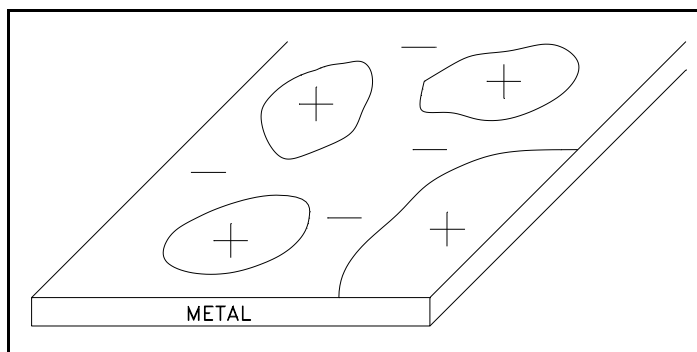

Figure 2 Metal Surface Showing Arrangement of Micro-cells

## Oxidation-Reduction Reactions

The corrosion of a metal (that is, the chemical transformation that is recognized as destructive to the metal) is the oxidation step of the overall oxidation-reduction process. Oxidation is the process of losing electrons; reduction is the process of gaining electrons. The metal atoms release electrons (are oxidized) and become positive ions. The site at which this occurs is known as the anode. Typical oxidation half-reactions include the following.



The cations (positive ions) may then go into solution, or they may combine with any available anions (negative ions) or water to form ionic compounds. The exact fate of the cations is important to subsequent processes, but the primary effect is that atoms leave the metallic state, and the metal deteriorates.

An oxidation process cannot take place without a simultaneous reduction (gain of electrons) process. The nature of the reduction step in corrosion sometimes varies with the metal and the environment to which it is exposed. For most metals in an aqueous environment, the important reduction half-reaction is the reduction of hydronium ions (a hydronium ion is simply a hydrogen ion attached to a water molecule).



Small concentration variations within a solution in contact with the metal may also affect the rate and nature of corrosion reactions. Therefore, it is often impossible to predict the exact nature of corrosion reactions. It is generally found, however, that for most metals exposed to an aqueous environment the half-reactions involved in corrosion are the reduction reaction of Equation (2-4) and an oxidation half-reaction of the type shown in Equations (2-1) through (2-3).

*General corrosion* is the process whereby the surface of a metal undergoes a slow, relatively uniform; removal of material. This occurs on the surface of a single metal rather than dissimilar metals. In general corrosion, a nearly infinite number of micro-cells are established on the metal surface. Oxidation occurs at anodic areas and reduction at cathodic areas. The micro-cells are uniformly distributed over the metallic surface, and as the reaction proceeds the cells may migrate, or disappear and re-form. That is, any particular micro-region may be alternately anodic and cathodic. The result is a uniform attack on the metal surface.

Under some conditions, relatively large regions become anodic or cathodic. Such regions have less tendency to migrate and may remain operative for long periods of time. In this case, there will be severe attack of the metal at the anodic (oxidation) region. The result may be a visible pit in the metal surface.

Iron and steel are resistant to rapid corrosion in water despite the tendency of iron to oxidize as indicated by its standard electrode potential listed in Table 1. The reasons for this resistance are the passivating effect of the oxide film and cathodic polarization due to atomic hydrogen that absorbs on the oxide surface, both of which are explained in the next section.

## **Passivity and Polarization of Metal**

Metals that normally fall victim to corrosion will sometimes exhibit a passivity to corrosion. *Passivity* is the characteristic of a metal exhibited when that metal does not become active in the corrosion reaction. Passivity is caused by the buildup of a stable, tenacious layer of metal oxide on the surface of the metal. This oxide layer is formed by corrosion on a clean metal surface, where the corrosion products are insoluble in the particular environment to which the metal is exposed. Once the layer, or film, is formed, it acts as a barrier separating the metal surface from the environment. For further corrosion to occur, the reactants must diffuse through the oxide film. Such diffusion is very slow or nonexistent, thus corrosion either decreases markedly or stops.

Metals such as zirconium, chromium, aluminum, and the stainless steels form thin, tenacious oxide films when exposed to the atmosphere or to pure water at room temperature. In some cases, the film is extremely thin and may be invisible to the unaided eye, but it is still very effective in giving these metals a marked passivity.

If there is a net conversion of reactants to products in a system, the system will be chemically unstable, and the reaction will continue until a stable state is attained. This stable state is known as equilibrium.

An active electrochemical cell (oxidation-reduction reaction) is an unstable chemical system. The potential associated with a galvanic cell, for example, steadily decreases as current flows and the oxidation-reduction reaction proceeds. Eventually, the potential falls to zero, the cell no longer supplies electrical energy, and no further net reaction takes place. At this point the system is at equilibrium. In electrochemical cells, the decrease in cell potential caused by the operation of the cell (current flow) is called *polarization*.

This change in cell potential can be determined. Consider the zinc-copper galvanic cell shown in Figure 3. As the reaction takes place,  $Zn^{+2}$  ions (produced by the oxidation of zinc metal) pass into solution. The  $Cu^{+2}$  ions in solution are reduced as the copper metal plates out. Thus, the concentration of  $Zn^{+2}$  in solution increases and the concentration of  $Cu^{+2}$  decreases according to the following overall reaction.

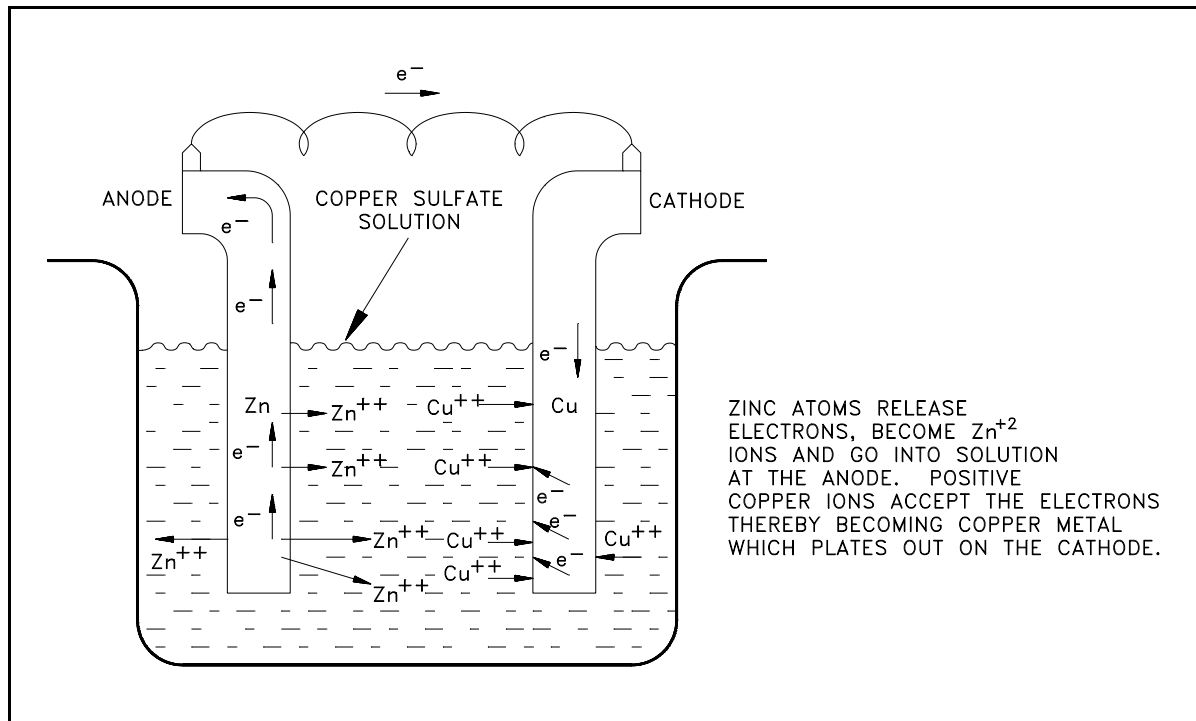
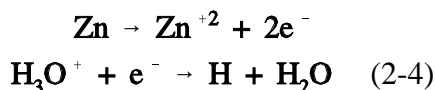

Figure 3 A Galvanic Cell

As  $Zn^{+2}$  increases and  $Cu^{+2}$  decreases, the electrical potential decreases. This decrease in cell potential, which results from changes in concentrations, is one form of polarization called concentration polarization.

Now consider a galvanic cell with zinc and platinum electrodes, such as that shown in Figure 4. The half-reactions in the cell are as follows.



Again, as the cell operates, the cell potential drops. The decrease is partially due to the increase in  $\text{Zn}^{+2}$  concentration and the decrease in  $\text{H}_3\text{O}^{+}$  concentration, but another type of polarization also occurs in this cell. This second type is associated with the reduction half-reaction.

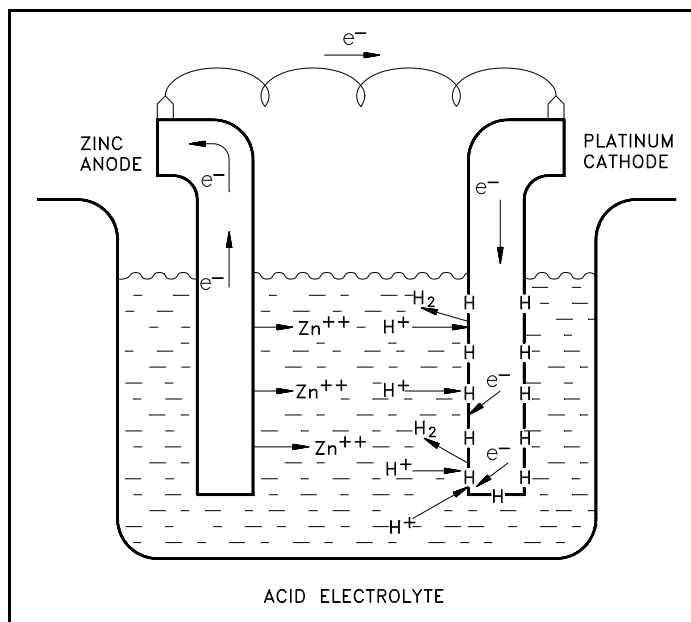
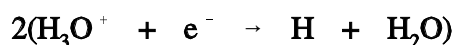

Figure 4 A Galvanic Cell Showing Absorbed Hydrogen Atoms on a Cathode

The hydrogen atoms formed by the reaction of Equation (2-4) absorb on the surface of the metal and remain there until removed by one of two processes: combination of two hydrogen atoms to form molecular hydrogen, which is then released as a gas or reaction with dissolved oxygen to form water. In the absence of oxygen (deaerated solutions), the first process applies.



Combining Equation (2-6) with Equation (2-4), the net reduction half-reaction is obtained.



Until the absorbed hydrogen atoms are removed from the metal surface, they effectively block the sites at which the reaction of Equation (2-4) can occur. At low temperatures the reaction of Equation (2-6) is slow relative to the reaction of Equation (2-4) because, although the reaction is energetically favored, the combination of two hydrogen atoms requires a large activation energy. Equation (2-6) shows the rate-controlling step of the net reduction half-reaction. Because the oxidation half-reaction can occur no faster than the reduction half-reaction, the rate of the overall oxidation-reduction reaction is controlled by the reaction of Equation (2-6).

The layer of absorbed atomic hydrogen is said to polarize the cell. This type of polarization is called activation polarization and is sometimes referred to as hydrogen polarization, or cathodic polarization, because the polarizing reaction occurs at the cathode.

Both concentration and activation polarization decrease the net oxidation-reduction reaction rate. In corrosion processes, activation polarization usually has the greater effect.

## **Summary**

The important information in this chapter is summarized below.

### **Corrosion Theory Summary**

- Ionization is the process of adding electrons to or removing electrons from atoms or molecules which creates ions.
- Conductivity is a measure of the ability of a substance to allow electron flow.
- Corrosion is the deterioration of a material due to interaction with its environment.
- Electrolysis is the decomposition by electric current.
- General corrosion is the process whereby the surface of a metal undergoes a slow, relatively uniform, removal of material.
- Corrosion is electrochemical in nature because the corrosive chemical reactions involve a transfer of charge. The metal ions go into solution causing the metal to become negatively charged with respect to the electrolyte. The difference in the charge causes a potential to develop and produces a voltage between the electrolyte and the metal.
- The oxidation step of the oxidation-reduction process is where an atom (in this case a metal atom) releases electron(s) and becomes a positively-charged ion. The areas where oxidation takes place become electrochemical cells made up of two different substances. The oxidation step results in a chemical transformation that is destructive to the metal. The positive metal ions may go into solution, or they may combine with any available negative ions or water to form ionic compounds. An example of the oxidation step is:



### Corrosion Theory Summary (Continued)

- The reduction step of the oxidation-reduction process is where a positively-charged ion gains electron(s). The reduction step for most metals, in an aqueous environment, is the reduction of hydronium ions. An example of the reduction step is:

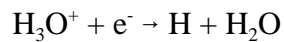

- Passivity is the buildup of a stable, tenacious layer of metal oxide on the surface of the metal that acts as a barrier separating the metal surface from the environment. Passivity decreases or stops the corrosion process because of the formation of the layer.
- Polarization is the decrease in cell potential caused by the operation of the electrochemical cell. Polarization can be in two forms; concentration or activation. Concentration polarization is associated with the concentration of ions in solution which shields the metal, thereby causing a decrease in the electrical potential of the cell. Activation polarization is the formation of a layer containing absorbed hydrogen atoms that block the metal's surface from the corrosion process.



---

## **GENERAL CORROSION**

---

*This chapter describes the general corrosion processes of iron and carbon steel (not stainless steels) in aqueous environments. Of particular interest is the formation of the oxide film and the effects of system variables on the corrosion process.*

- EO 1.7**      **LIST the two conditions that contribute to general corrosion.**
- EO 1.8**      **DESCRIBE how the rate of corrosion occurring in the plant is effected by the following:**
- a.**      **Temperature**
  - b.**      **Water velocity**
  - c.**      **Oxygen**
  - d.**      **pH**
  - e.**      **Condition and composition of the metal surface**
  - f.**      **Dissolved solids**
- EO 1.9**      **LIST the three products that are formed from the general corrosion of iron.**
- EO 1.10**     **IDENTIFY the action taken for initial fill of a reactor system to limit general corrosion.**
- EO 1.11**     **STATE the four methods used to chemically control general plant corrosion.**
- EO 1.12**     **LIST the six water chemistry conditions that limit corrosion of aluminum.**

---

### **Conditions Contributing to General Corrosion**

General corrosion is the process whereby the surface of a metal undergoes a slow, relatively uniform, removal of material. The two conditions typically required for a metal to undergo general corrosion are: 1) metal and water in the same environment, and 2) a chemical reaction between the metal and water that forms an oxide.

## **Corrosion of Iron**

Unless noted otherwise, the following discussion applies to deaerated water at room temperature and approximately neutral pH. The affects of temperature, oxygen, and pH are discussed later in this chapter.

The oxidation and reduction half-reactions in the corrosion of iron are as follows.

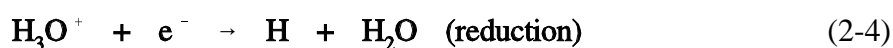

The overall reaction is the sum of these half-reactions.



The  $\text{Fe}^{+2}$  ions readily combine with  $\text{OH}^{-}$  ions at the metal surface, first forming  $\text{Fe}(\text{OH})_2$ , which decomposes to  $\text{FeO}$ .

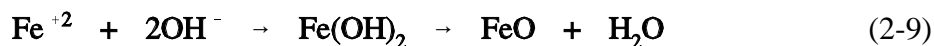

Ferrous oxide ( $\text{FeO}$ ) then forms a layer on the surface of the metal. Below about  $1000^{\circ}\text{F}$ , however,  $\text{FeO}$  is unstable and undergoes further oxidation.

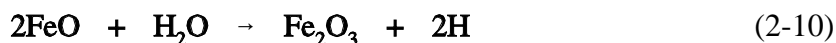

Atomic hydrogen then reacts to form molecular hydrogen, as described previously, and a layer of ferric oxide ( $\text{Fe}_2\text{O}_3$ ) builds up on the  $\text{FeO}$  layer. Between these two layers is another layer that has the apparent composition  $\text{Fe}_3\text{O}_4$ . It is believed that  $\text{Fe}_3\text{O}_4$  is a distinct crystalline state composed of  $\text{O}^{-2}$ ,  $\text{Fe}^{+2}$ , and  $\text{Fe}^{+3}$  in proportions so that the apparent composition is  $\text{Fe}_3\text{O}_4$ . These three layers are illustrated in Figure 5.

Once the oxide film begins to form, the metal surface is no longer in direct contact with the aqueous environment. For further corrosion to occur, the reactants must diffuse through the oxide barrier. It is believed that the oxidation step, Equation (2-3), occurs at the metal-oxide interface. The  $\text{Fe}^{+2}$  ions and electrons then diffuse through the oxide layer toward the oxide-water interface. Eventually,  $\text{Fe}^{+2}$  ions encounter  $\text{OH}^{-}$  ions and form  $\text{FeO}$ . The electrons participate in the reduction reaction with hydronium ions. These latter reactions are believed to take place predominately at the oxide-water interface, but some reaction may occur within the oxide layer by the diffusion of  $\text{H}^{+}$ ,  $\text{OH}^{-}$ , and  $\text{H}_2\text{O}$  into the layer.

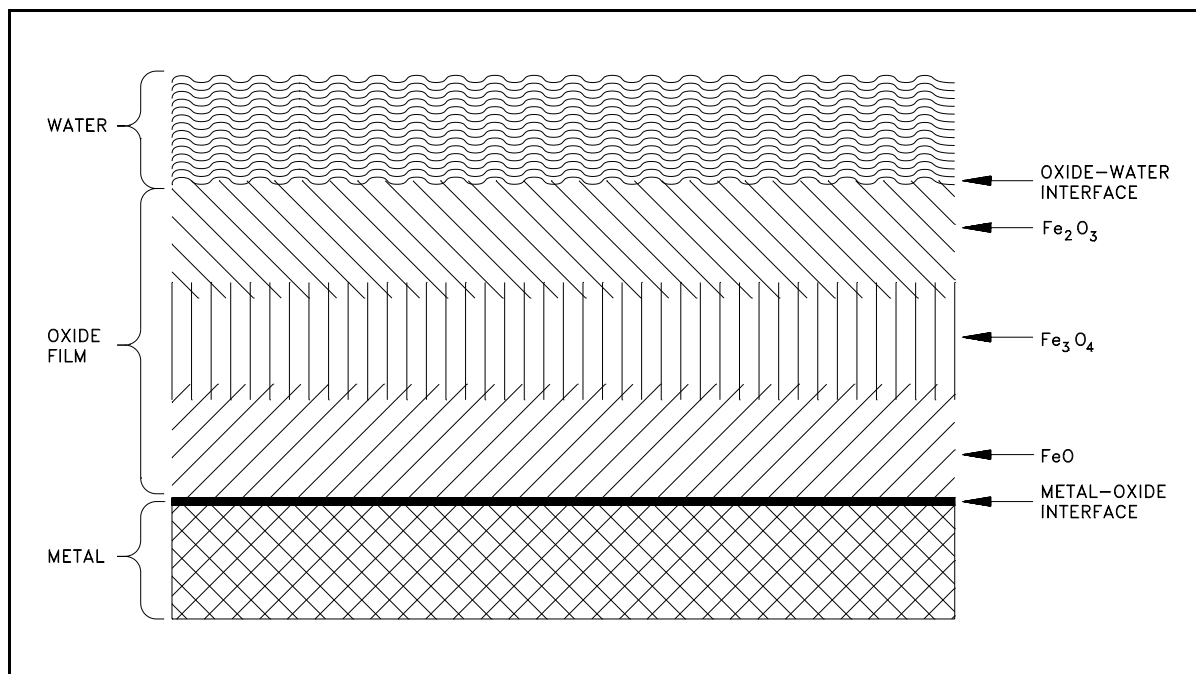

Figure 5 Simplified Schematic Diagram of Oxide Corrosion Film on the Surface of a Metal

Regardless of the exact diffusion mechanism, the oxide layer represents a barrier to continued corrosion and tends to slow the corrosion rate. The exact effect of this layer on the corrosion rate depends on the uniformity and tenacity of the film. If the film is loosely attached, develops defects, or is removed, the metal surface is again exposed to the environment and corrosion occurs more readily.

### **Factors Affecting General Corrosion Rate**

Like most other chemical reactions, corrosion rates increase as temperature increases. Temperature and pressure of the medium govern the solubilities of the corrosive species in the fluid, such as oxygen (O<sub>2</sub>), carbon dioxide (CO<sub>2</sub>), chlorides, and hydroxides. A rule of thumb is that the reaction rate doubles with a 20°F to 50°F temperature rise. This linear increase with temperature does not continue indefinitely due, in part, to a change in the oxide film.

When water velocity is extremely high, the impact of the water tends to remove the protective oxide layer and some of the metal under it (erosion), thus, exposing more metal to corrosion. Water velocities of 30 to 40 ft per second are usually considered to cause erosion.

The presence of oxygen in water to which iron is exposed increases the corrosion rate. The reason for this increase is the rapid reaction between oxygen and the polarizing layer of atomic hydrogen absorbed on the oxide layer. The following reaction rapidly removes the polarizing layer.

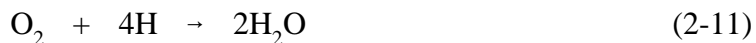

The overall reaction can be obtained by combining Equations (2-4) and (2-11).



The controlling step is believed to be diffusion of  $\text{O}_2$  to the metal surface where it can react directly with iron or with  $\text{FeO}$ .

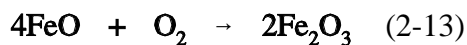
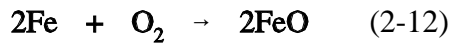

Oxygen, therefore, has two effects: it removes the polarizing layer of atomic hydrogen, and it can react directly with the metal or metal oxide; thus, the corrosion rate increases. Substances, such as  $\text{O}_2$  in this case, that remove the absorbed atomic hydrogen are called depolarizers. The depolarizing effect of  $\text{O}_2$  is illustrated in Figure 6.

The effect of the pH of water to which iron or steel is exposed is influenced by temperature in the following manner. The potential of hydrogen or symbol (pH) is defined as the negative logarithm of the hydrogen concentration, represented as  $[\text{H}^+]$  in moles/liter.

$$\text{pH} = -\log [\text{H}^+]$$

The pH value is used to represent the acidity of a solution.

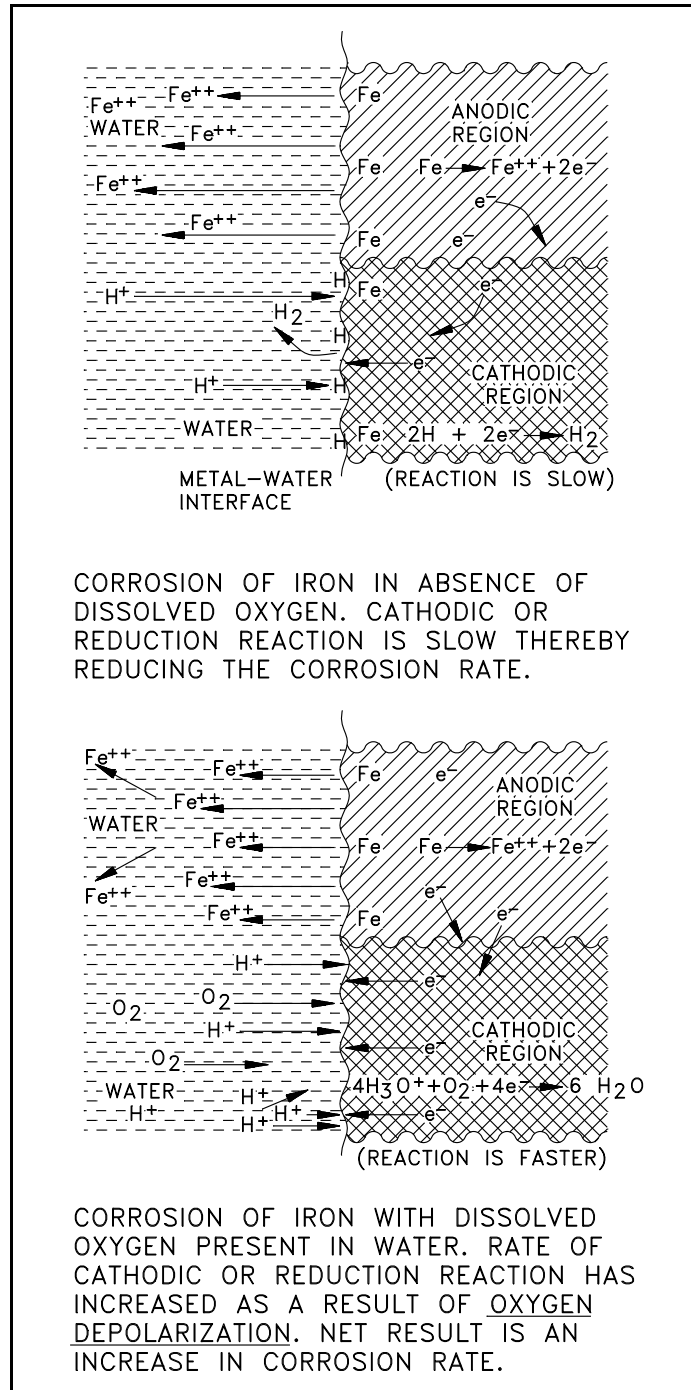

Figure 6 Representation of Cathodic Depolarization by Oxygen

First, consider the exposure of iron to aerated water at room temperature (aerated water will contain dissolved oxygen). The corrosion rate for iron as a function of pH is illustrated in Figure 7. In the range of pH 4 to pH 10, the corrosion rate of iron is relatively independent of the pH of the solution. In this pH range, the corrosion rate is governed largely by the rate at which oxygen reacts with absorbed atomic hydrogen, thereby depolarizing the surface and allowing the reduction reaction to continue. For pH values below 4.0, ferrous oxide (FeO) is soluble. Thus, the oxide dissolves as it is formed rather than depositing on the metal surface to form a film. In the absence of the protective oxide film, the metal surface is in direct contact with the acid solution, and the corrosion reaction proceeds at a greater rate than it does at higher pH values. It is also observed that hydrogen is produced in acid solutions below a pH of 4, indicating that the corrosion rate no longer depends entirely on depolarization by oxygen, but on a combination of the two factors (hydrogen evolution and depolarization). For pH values above about pH 10, the corrosion rate is observed to fall as pH is increased. This is believed to be due to an increase in the rate of the reaction of oxygen with  $\text{Fe}(\text{OH})_2$  (hydrated FeO) in the oxide layer to form the more protective  $\text{Fe}_2\text{O}_3$  (note that this effect is not observed in deaerated water at high temperatures).

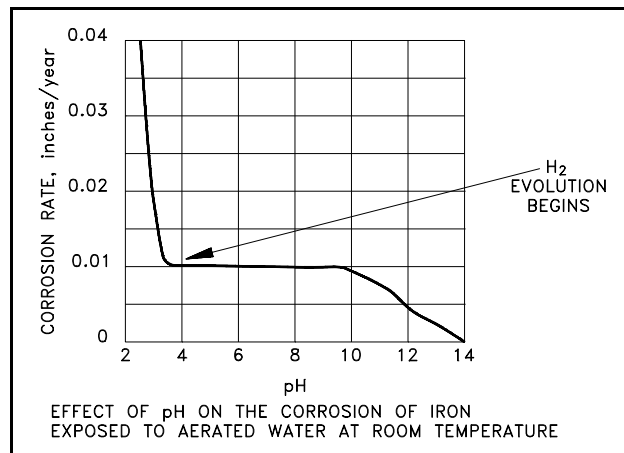

Figure 7 Effect of pH on the Corrosion Rate of Iron in Water

A plot of the relative corrosion rate for iron at various pH values in 590°F, oxygen-free water is presented as Figure 8. The curve illustrates that the corrosion rate of iron in high temperature water is lower in the pH range of 7 to 12 than it is at either lower or higher pH values (at very high pH values, greater than pH 13.0, the oxide film becomes increasingly more soluble because of increased formation of soluble  $\text{FeO}_2$  at high temperatures, and corrosion rates increase). As a result of the data plotted in Figure 8 and other similar measurements, it is general practice to maintain high temperature water in the alkaline condition (but below very high pH values) to minimize the corrosion of iron and the steels exposed to the high temperature water.

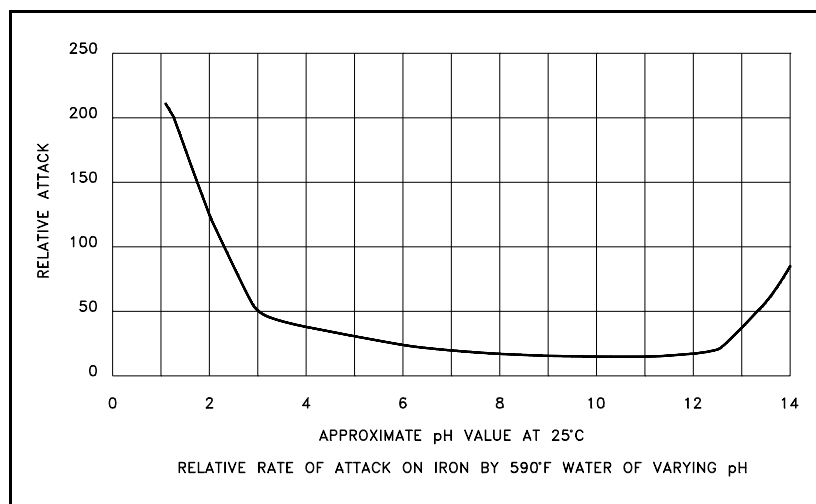

Figure 8 Effect of pH on the Relative Attack Rate of Iron in Water

The hydrogen normally dissolved in reactor coolant does not have any detectable direct effect upon the corrosion rate of the iron and steels exposed to reactor coolant. It does, however, have an important indirect effect by preventing the accumulation of dissolved oxygen in reactor coolant, which would accelerate corrosion. Dissolved oxygen reacts with the protective hydrogen gas layer at the cathode to form water.

The condition and composition of the metal surfaces affects the corrosion rate. Deposits, scale, or irregular surfaces create areas on the metal where local corrosion can initiate and proceed at a faster rate than normal. Certain alloys of metals have higher corrosion resistance than others, as discussed in the Material Science Handbook.

When iron or steel is exposed to high temperature water, the rate of corrosion of the metal is observed to decrease with exposure time during the early period of exposure. After a few thousand hours, the corrosion rate becomes relatively constant at a low value. During the early period of exposure, while the corrosion rate is decreasing, the oxide film on the surface of the metal grows in thickness. However, the rate at which the film grows decreases with time. The thickness of the oxide film soon reaches a relatively constant value, and thereafter film thickness does not change appreciably with further exposure. As might be expected, a relatively constant corrosion rate and oxide film thickness are attained at about the same time. Because a tightly adhering corrosion film inhibits further corrosion, great care is taken during the initial fill of reactor plants to promote formation of the best possible corrosion film. This process, referred to as pretreatment, or pickling, involves careful control of reactor coolant water chemistry and temperature during the pretreatment period.

## **Prevention Chemistry Control**

Plant chemistry is used to control corrosion. The type of corrosion determines the method used for preventing or minimizing the corrosion rate.

### **Passivators and Inhibitors**

Passivation is the condition where a naturally active metal corrodes at a very low rate, probably due to an oxide coating or an absorbed layer of oxygen. Some chemical substances, called passivators or inhibitors, if added to water, can provide this type of passivation by undergoing reduction at the metal surface. A common inhibitor is potassium chromate.

### **Cathodic Protection**

The use of cathodic protection, supplying an external electric current to the iron so that it acts as a cathode and has no anodic areas, is another method of preventative chemical control. This can be accomplished by the use of an external voltage source or by the use of a sacrificial anode (e.g., zinc) which will corrode and provide the current.

## **Removing Corrosive Agents**

Chemistry control in the form of removal of corrosive agents from a system is a widely used method. One method is using deaerators to remove dissolved oxygen and to a lesser extent carbon dioxide. Treating the water by softening and demineralization removes the dissolved solids and reduces the conductivity.

## **Chemical Addition**

Chemical additions to a system that alter the chemical reaction or tie up a particular corrodant is a common method of control. Filming amines (organic compounds that are derivatives of ammonia) accomplish protection by forming adhering organic films on metal surfaces to prevent contact between corrosive species in the condensate and the metal surface. Phosphates and sodium hydroxide are used to adjust the system pH and remove hardness.

## **Corrosion of Aluminum**

The corrosion of aluminum is dependent upon a vast number of variables. These variables include environment, temperature, alloy in question, flow velocities, impurities present in the environment, and chemistry conditions to which it is exposed. An additional factor that affects corrosion is pretreatment.

Many of the factors are controlled by design and construction, such as alloy type, temperature, and flow velocities. Pretreatment, soluble and solid impurities, and chemistry are within the control of the operator and will be discussed in this text.

Experiments have shown that prefilming limits corrosion on aluminum-clad fuel assemblies. In the tests conducted, the ratios of oxide film thickness for nonprefilmed and prefilmed elements were on the order of 2 to 3 and in some cases even greater.

Impurities are major contributors to the corrosion of aluminum. In most cases studied, the major source of contaminants has been makeup water systems. Corrosion products from other plant materials also contribute to the overall inventory of ionic and solid impurities. Finally, organic impurities from the resin used in ion exchangers have been detected. These occur in some installations because of the type of resin used and the particle filters normally installed on the ion exchanger effluents. This problem has been reduced by improved resins and installing filters capable of removing smaller particles.

Chemistry controls, including pH, dissolved oxygen, and conductivity, greatly influence the formation and propagation of the oxide film on aluminum surfaces. Dissolved oxygen is controlled for essentially the same reasons as for the corrosion of iron. Conductivity is a quantitative indication of the impurities present in the system, and pH theoretically dictates the value of conductivity.

For those reactor plants in which aluminum is used for cladding and other structural components, pH is controlled in an acidic condition because of the corrosion properties of aluminum. Plant pH has a marked effect on the rate of chemical reaction between the coolant water and aluminum. In the area of the cladding, the corrosion reduces the thickness and forms an oxide film that is a thermal barrier. Extensive tests carried out in support of DOE test reactors have revealed that minimum aluminum corrosion results with a pH of 5.0 at normal operating temperatures. Additionally, studies have shown that the aluminum corrosion products also exhibit a minimum solubility at a pH near 5.5 at 25°C. The aluminum corrosion products tend to reduce the substrate (base) aluminum metal corrosion rates. Because it is desirable to maintain dissolved aluminum in the reactor coolant at the lowest practicable level, it is desirable to maintain the system pH level in the range of minimum oxide solubility. Figure 9 shows the effect of pH on aluminum oxide solubilities for various forms of oxide, and the effect of pH on corrosion rates. It should be noted that the values at which minimum corrosion and solubility are found shift to a lower pH as the temperature is increased. For example, at 300°C, the value for minimum aluminum corrosion is near pH 3.0. Therefore, the optimum pH for operation is determined by the operating temperature.

The conditions that have proven to be most effective in limiting corrosion of aluminum are as follows.

- Maintaining pH slightly acidic with the value of the pH depending largely upon operating temperature
- Elimination of dissolved oxygen
- Elimination of soluble and solid impurities
- Prevention of the introduction of organic impurities
- Pretreatment (or pickling)
- Maintaining water purity



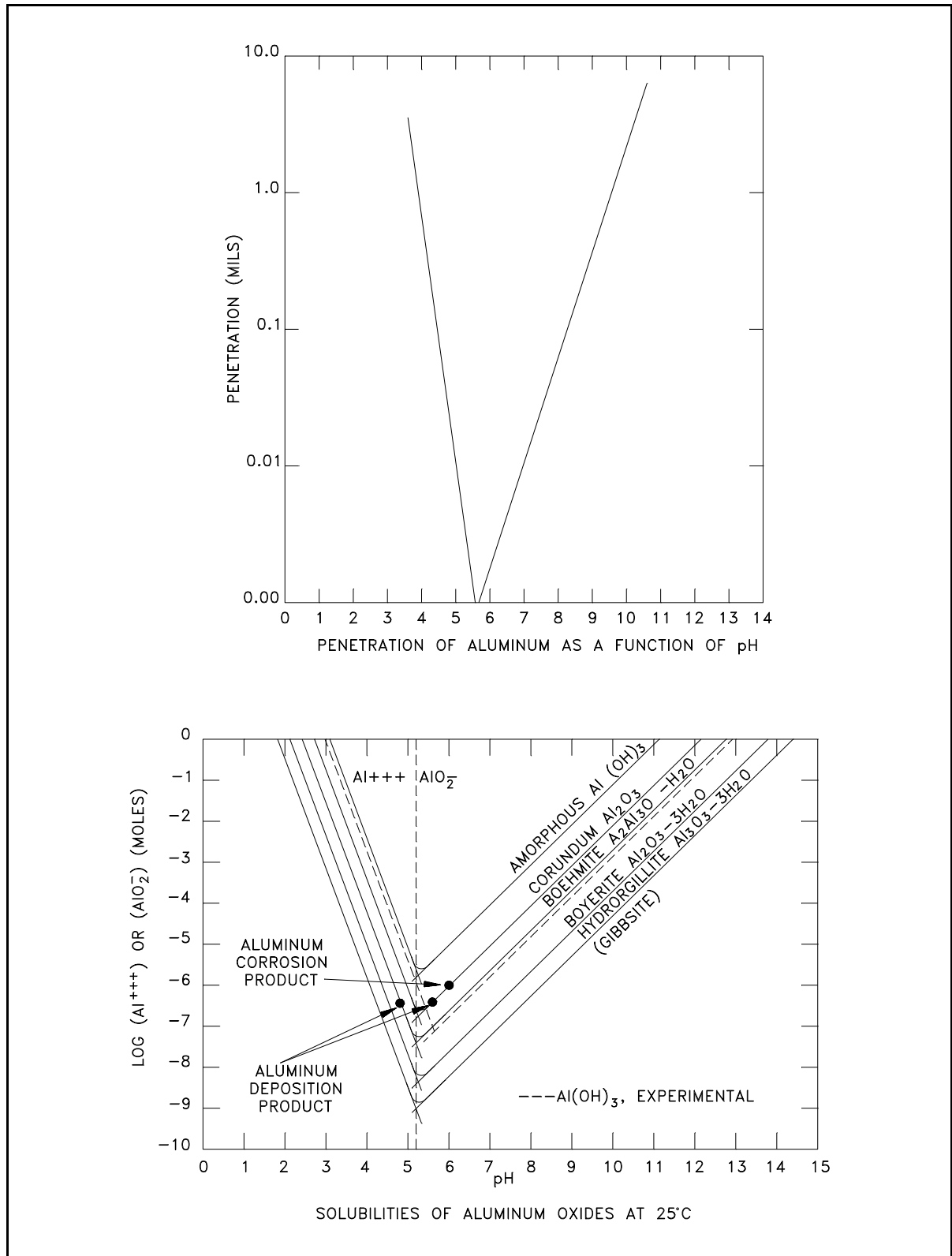

Figure 9 Effect of pH on Aluminum Corrosion and Oxide Solubility

## **Summary**

The major points of this chapter are summarized below.

### **General Corrosion Summary**

- The two conditions that contribute to general corrosion are:

Metal and water in the same environment  
Chemical reaction between the metal and water to form an oxide

- The corrosion rate is affected by the following:

A temperature rise in the range of 20°F to 50°F doubles the corrosion rate until the formation of the protective oxide film is complete.

An extremely high water velocity, 30 to 40 ft per second, tends to remove the oxide film allowing the corrosion rate to increase.

The presence of oxygen in water to which iron is exposed increases the corrosion rate. The reason for the corrosion rate increase is due to the rapid reaction between the oxygen and the polarizing layer of hydrogen absorbed on the oxide layer.

A pH between 4 and 10 results in minimal corrosion rate. If the pH falls below or above this range, the corrosion will normally increase.

The condition and composition of the metal surfaces affects the corrosion rate. Deposits, scale, or irregular surfaces create areas on the metal where local corrosion can initiate and proceed at a faster rate than normal.

Dissolved solids tend to make it easier for current to flow, which results in a higher corrosion rate.

- The three products formed from general corrosion of iron are FeO, Fe<sub>2</sub>O<sub>3</sub>, and Fe<sub>3</sub>O<sub>4</sub>.

### General Corrosion Summary (Cont.)

- During the initial fill of a reactor system, great care is taken to promote the formation of the best possible protective corrosion film. The protective film acts as a barrier and stops further uncontrolled corrosion from taking place. This process, called pretreatment or pickling, involves careful control of reactor coolant water chemistry and temperature during the pretreatment period.

- Four methods used to chemically control general plant corrosion are:

Passivators (inhibitors) consist of a naturally active metal that corrodes at a very low rate. A common passivator is potassium chromate.

Cathodic protection is the external application of an external electric current to the iron so that it acts as a cathode and has no anodic areas. This is accomplished by using either an external electrical source or the use of a sacrificial anode to provide the electrical current.

Removing corrodants to reduce the dissolved oxygen and lesser extent carbon dioxide. Treating the water in this manner reduces the dissolved solids and reduces the conductivity.

Chemical addition to alter the chemical reaction or tie up a particular corrodant. Filming amines, phosphates, and sodium hydroxide are used to provide organic films and adjust the system pH.

- The six water chemistry conditions that limit corrosion of aluminum are:

Maintaining pH slightly acidic with the value of the pH depending largely on operating temperature.

Elimination of dissolved oxygen

Elimination of soluble and solid impurities

Prevention of the introduction of organic impurities

Pretreatment (or pickling)

Maintaining water purity

---

## CRUD AND GALVANIC CORROSION

---

*A major potential problem is crud. Crud can cause an increase in background radiation levels. When two dissimilar metals are in close vicinity, the opportunity for ion transfer is high. The result is a perfect environment for galvanic corrosion. Because of the numerous types of materials used in nuclear facilities, galvanic corrosion is a major concern.*

**EO 1.13     DEFINE the following terms:**

- a.        **Crud**
- b.        **Scale**
- c.        **Galvanic corrosion**

**EO 1.14     IDENTIFY the five problems associated with the presence or release of crud into reactor coolant.**

**EO 1.15     STATE the four causes of crud bursts.**

**EO 1.16     STATE the two conditions that can cause galvanic corrosion.**

**EO 1.17     EXPLAIN the mechanism for galvanic corrosion.**

**EO 1.18     IDENTIFY the two locations that are susceptible to galvanic corrosion.**

**EO 1.19     STATE the five control measures used to minimize galvanic corrosion.**

---

### **Crud**

In addition to the corrosion film, corrosion products in the form of finely divided, insoluble oxide particles called *crud* become suspended in the reactor coolant or loosely adhere to metal surfaces. Crud has several undesirable characteristics. It can be transported throughout the reactor coolant system. As a result, it can accumulate and foul heat-transfer surfaces or clog flow passages. The most undesirable characteristic of crud, however, is that it becomes activated when exposed to radiation. Because crud can be transported throughout the reactor coolant system, it can collect outside the reactor core, causing radiation hot spots that increase ambient radiation levels. Hot spots caused by collections of crud may occur at the entrance to the purification heat exchanger and other areas of low flow velocity. Crud that is loosely adhered to metal surfaces can suddenly become suspended in the reactor coolant.

The crud release can result from an increased oxygen concentration, a reduced (or significantly changed) pH, a large temperature change (heatup or cooldown), or a physical shock to the system. Physical shocks include starting, stopping, or changing pump speeds, or other evolutions like a reactor scram or a relief valve lift. The result is a sudden increase in reactor coolant activity. The release of crud in this fashion is termed a crud burst. Crud bursts often lead to the removal of protective corrosion films and make the freshly exposed metal more susceptible to additional corrosion. In addition to the corrosion film and crud, some of the corrosion products are soluble and are easily transported throughout the system.

High crud concentrations in the system can also complicate disposal of primary coolant. Many of the corrosion products have relatively long half-lives and represent significant biological hazards. If, therefore, primary coolant is drained or leaks from the plant shortly after a crud burst, additional procedures may need to be utilized to minimize the effects of this condition.

Therefore, if the conditions mentioned previously ( $O_2$ , pH) are changed, the solubility of these corrosion products will change, and they can then be transported to and deposited anywhere in the reactor coolant system.

Another corrosion byproduct is *scale*, which is made up of deposits on surfaces from the formation of insoluble compounds from normally soluble salts. Most common are calcium or magnesium carbonates ( $CaCO_3$  or  $MgCO_3$ ).

## **Galvanic Corrosion**

*Galvanic corrosion* is the corrosion that results when two dissimilar metals with different potentials are placed in electrical contact in an electrolyte.

Of all the different types of corrosion, galvanic corrosion corresponds most closely to the electrochemical cells described previously in this module because galvanic corrosion occurs when two electrochemically dissimilar metals are joined together (in electrical contact) in a conducting medium (electrolyte). It may also take place with one metal with heterogeneities (dissimilarities) (for example, impurity inclusions, grains of different sizes, difference in composition of grains, differences in mechanical stress); abnormal levels of pH; and high temperatures. A difference in electrical potential exists between the different metals and serves as the driving force for electrical current flow through the corrodant or electrolyte. This current results in corrosion of one of the metals. The larger the potential difference, the greater the probability of galvanic corrosion. Galvanic corrosion only causes deterioration of one of the metals. The less resistant, active metal becomes the anodic corrosion site. The stronger, more noble metal is cathodic and protected. If there were no electrical contact, the two metals would be uniformly attacked by the corrosive medium as if the other metal were absent. Two locations susceptible to galvanic corrosion is a piping transition from one metal to another and a sacrificial anode (such as zinc).

Figure 10 illustrates that galvanic corrosion occurs when two different metals are in contact and exposed to an electrolyte.

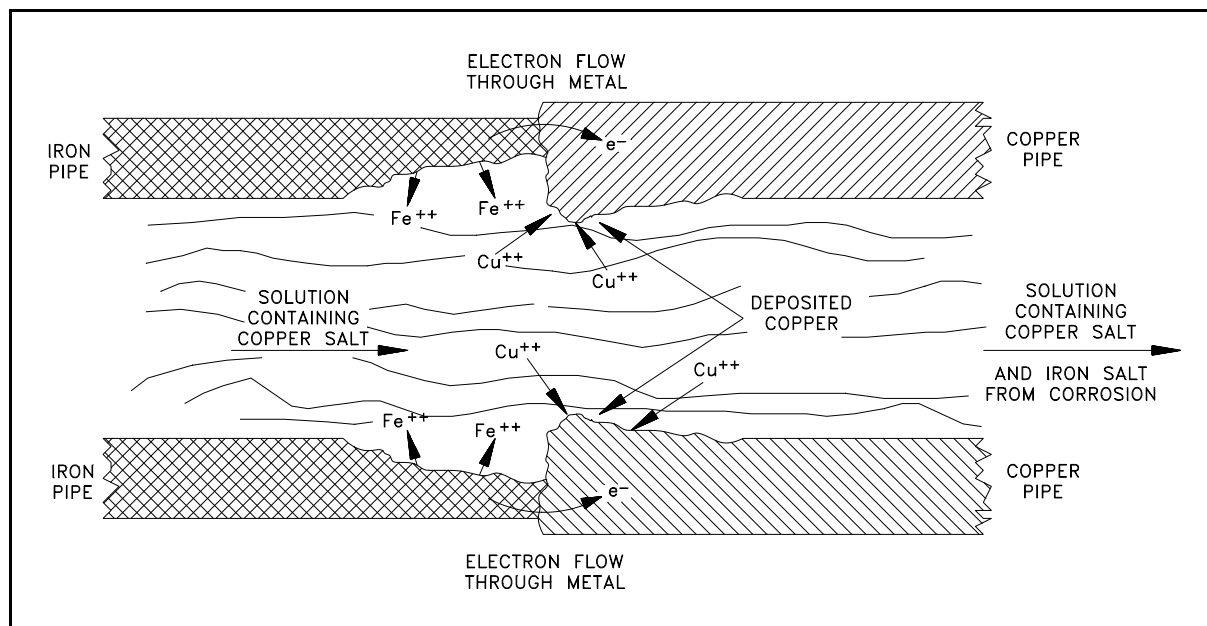
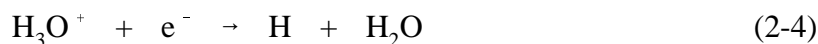

Figure 10 Galvanic Corrosion at Iron-Copper Pipe Junction

Figure 10 shows the junction of iron and copper pipes containing a solution of a copper salt. The oxidation potential of iron is sufficiently greater than that of copper so that iron is capable of reducing  $\text{Cu}^{+2}$  ions to copper metal. In this case, iron corrodes near the junction, and additional copper builds up on the copper pipe near the junction.

The solution to which the metal junction is exposed need not contain a salt of one of the metals for galvanic corrosion to occur. If the iron-copper junction were exposed to water without  $\text{Cu}^{+2}$  ions, the reduction reaction would be as shown in Equation (2-4).



Again, iron would corrode near the junction, but in this case hydrogen would be formed on the surface of the copper.

### **Prevention of Galvanic Corrosion**

A method called cathodic protection, discussed previously in this module, is often used to retard or eliminate galvanic corrosion. One of several ways of accomplishing this is to attach a third metal to the metals to be protected. This metal must have an oxidation potential even greater than that of the metal to be protected. The most active metal then tends to corrode in place of the protected metal. The metal that corrodes to protect another metal is called a sacrificial anode. This method is applied in the original design of structural materials. Zinc is a common sacrificial anode and is often used in cooling water systems that contain seawater.

Galvanic corrosion can also be limited by: 1) using only metals that are close on the activity series (discussed in the chapter on *Corrosion Theory*), 2) electrical insulation of dissimilar metals, and 3) using poorly-conducting electrolytes (very pure water).

The relative surface areas of the two metals are also important. A much larger surface area of the non-active metal, compared to the active metal, will accelerate the attack. It has been determined that the relative surface area is the determining factor in the corrosion rates.

The required electrical current for galvanic corrosion will be stopped if the dissimilar metals are:

- separated by a non-conducting junction,
- separated from a conductive environment, and
- located in a poorly conducting electrolyte (pure water).

## **Summary**

The important information of this chapter is summarized below.

### **Crud and Galvanic Corrosion Summary**

- Crud is corrosion products in the form of finely divided, insoluble oxide particles suspended in the reactor coolant or loosely adhered to metal surfaces or activated corrosion and wear products.
- Scale is the deposition on the surfaces of the piping from the formation of insoluble compounds from normally soluble salts. Most common are calcium or magnesium carbonates.
- Galvanic corrosion is the corrosion that results when two dissimilar metals with different potentials are placed in electrical contact in an electrolyte.
- The problems of crud in reactor plants are:
  - Fouling of coolant flow paths
  - Fouling of heat transfer surfaces
  - High general background (ambient) radiation levels
  - Radiation hot spots
  - Radioactive waste disposal

### Crud and Galvanic Corrosion Summary (Cont.)

- The causes of a crud burst in the reactor coolant are:
  - Increased oxygen concentration
  - Reduced (or significantly changed) pH
  - Large temperature change
  - Physical shock (for example, starting and stopping pumps, changing speeds of pumps, reactor scram, or relief valve lift)
  
- Galvanic corrosion functions on the principle of the electrochemical cell, and occurs when two electrochemically dissimilar metals are joined together in a conducting medium. The two dissimilar metals generate an electrical potential, and this electrical potential serves as the driving force for the electrical current flow through the corrodant or electrolyte. The less resistant metal, called the active metal, becomes anodic. The other metal, called the noble metal, becomes cathodic.
  
- The two locations susceptible to galvanic corrosion are piping transitions between two dissimilar metals and at sacrificial anodes.
  
- Measures used to control galvanic corrosion include:
  - Cathodic protection by introducing a third metal (sacrificial anode, normally zinc) to the metals being protected or using only metals that are close on the activity series.
  
  - Choosing relative surface areas such that the material to be protected has a larger surface area than the active metal.
  
  - Separating dissimilar metals with a non-conducting material
  
  - Separating the metals from a conductive environment
  
  - Use of poorly conducting electrolytes (pure water)



---

## SPECIALIZED CORROSION

---

*The environment in which a metal exists has direct bearing on the corrosion rate of that metal. Because of the unique environment possible in the nuclear industry, there are a few specialized types of corrosion that must be considered.*

**EO 1.20** DEFINE the following terms:

- a. **Pitting corrosion**
- b. **Crevice corrosion**
- c. **Stress corrosion cracking**

**EO 1.21** STATE the two conditions necessary for pitting corrosion to occur.

**EO 1.22** STATE the particular hazard associated with pitting corrosion.

**EO 1.23** STATE the four controls used to minimize pitting corrosion.

**EO 1.24** IDENTIFY the three conditions necessary for stress corrosion cracking to occur.

**EO 1.25** DEFINE the term chemisorption.

**EO 1.26** STATE the hazard of stress corrosion cracking.

**EO 1.27** STATE the three controls used to prevent stress corrosion cracking.

**EO 1.28** DESCRIBE the two types of stress corrosion cracking that are of major concern to nuclear facilities including:

- a. **Conditions for occurrence**
- b. **Method(s) used to minimize the probability of occurrence**

---

### Pitting and Crevice Corrosion

Another possible effect of dissolved oxygen is accelerated localized attack. This is especially likely in areas of limited circulation. The resulting corrosion is called pitting corrosion.

*Pitting corrosion* occurs where the anodic site becomes fixed in a small area and the formation of holes (deep attack) in an otherwise unaffected area takes place. *Crevice corrosion* is a type of pitting corrosion that occurs specifically within the low flow region of a crevice.

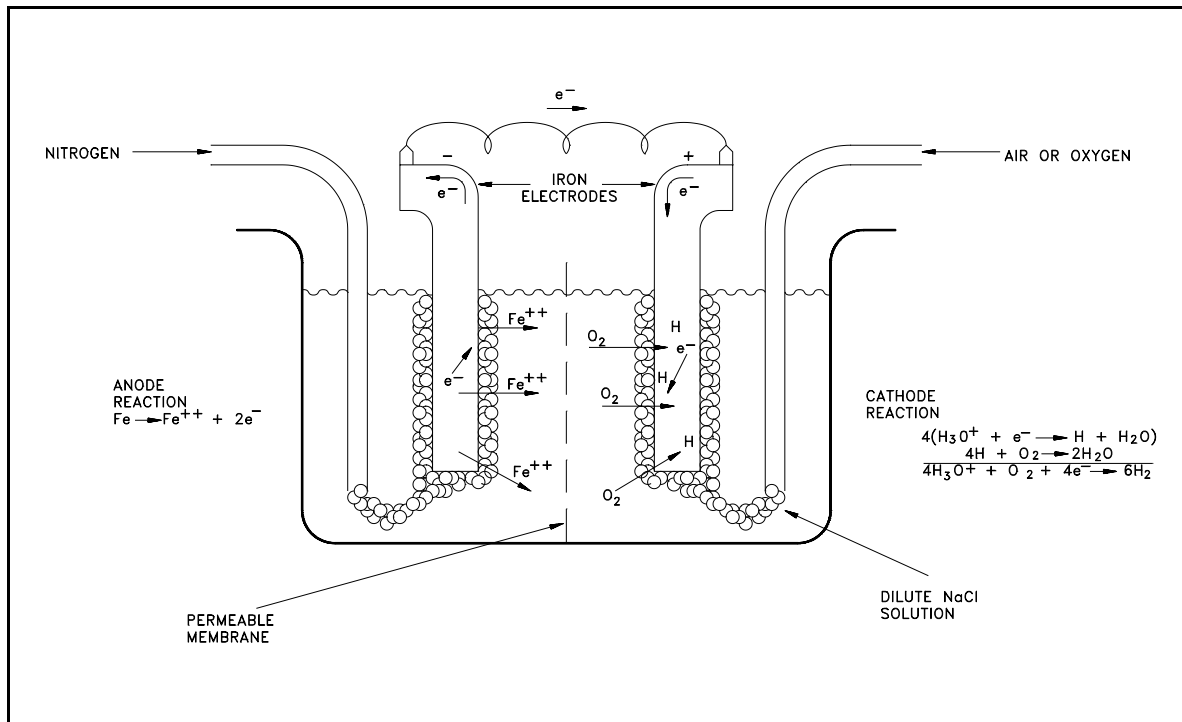

Figure 11 Differential Aeration Cell

To illustrate pitting attack, consider a special type of galvanic cell called a differential aeration cell such as the one illustrated in Figure 11. This particular differential aeration cell is showing current flow as a result of depolarization of one electrode (cathode) by oxygen. In this type of cell, two iron electrodes are exposed to a dilute solution of an electrolyte (NaCl, for example). Air (or oxygen) is bubbled around one electrode, and nitrogen is bubbled around the other. A current flows through the wire connecting the two electrodes. The difference in potential is a result of the difference in oxygen concentration at the two electrode surfaces. At the electrode exposed to nitrogen, electrons are given up by the iron as it is oxidized. These electrons readily flow through the external circuit to the electrode exposed to oxygen. At this depolarized electrode they can participate in a reduction reaction. As a result, oxidation occurs at the electrode exposed to nitrogen and reduction occurs at the aerated electrode. Oxidation at one electrode and reduction at the other creates a potential and a flow of current through the connecting wire. Note that loss of metal occurs at the electrode that is deficient in oxygen.

In iron that is exposed to water, a similar action can occur if adjacent areas of the metal surface become exposed to solutions with different oxygen concentrations. For example, the solution in a crevice exchanges slowly with the bulk of the solution outside the crevice. Oxygen in the solution inside the crevice will be depleted initially by the corrosion reaction.



This reaction alone does not produce a protective film on the metal. Because of restricted flow into the crevice, replenishment of oxygen will be very slow; therefore, the solution inside the crevice will have a low oxygen concentration relative to that outside the crevice as shown in Figure 12. The two adjacent areas then establish a concentration cell with electrons flowing from the region of low oxygen concentration to the region of high concentration. Thus, metal goes into solution (oxidation) inside the crevice, and reduction occurs outside the crevice. Metal ions diffuse out of the crevice, more metal dissolves, and the process continues. This results in the formation of a pit inside the crevice.

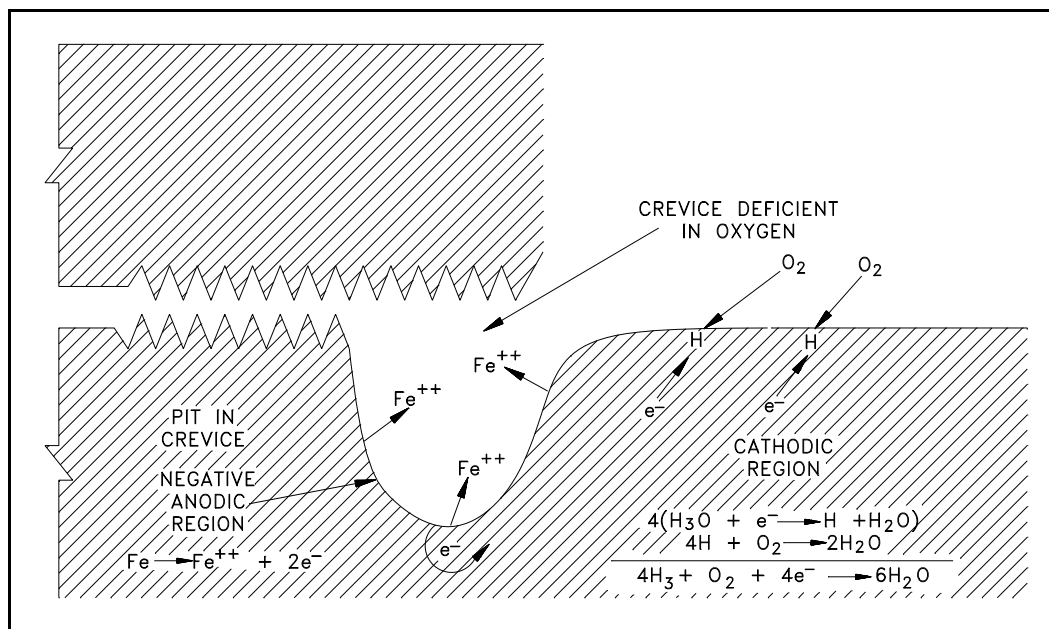

Figure 12 Representation of Crevice Pitting

The presence of oxygen can also promote pitting at areas on the metal surface that are initially anodic with respect to an adjacent area. For example, suppose that adjacent areas on a metal surface exhibit slightly different oxidation potentials. Oxidation, or loss of metal, proceeds at the region of higher potential. Corrosion in the region of higher potential leads to formation (at least initially) of a porous oxide film. The thickness of the film formed on the adjacent cathodic region will be much less. Oxygen in the bulk of solution can reach the cathodic surface (with the thin film) more readily than it can the nearby anodic surface region (with the thicker oxide film). Depolarization of the cathodic region (thin film) by oxygen tends to maintain this region cathodic, while a deficiency of oxygen under the thicker porous corrosion film assists in maintaining an anodic condition in this region. The overall result is corrosion, or wasting away, of the metal in the anodic region under the thicker film. Thus, a pit in the metal surface is formed under the mound of surface oxide, as illustrated in Figure 13. Pitting of this type is common in both low temperature and high temperature iron-water systems if precautions are not taken to remove the oxygen from the water within the system.

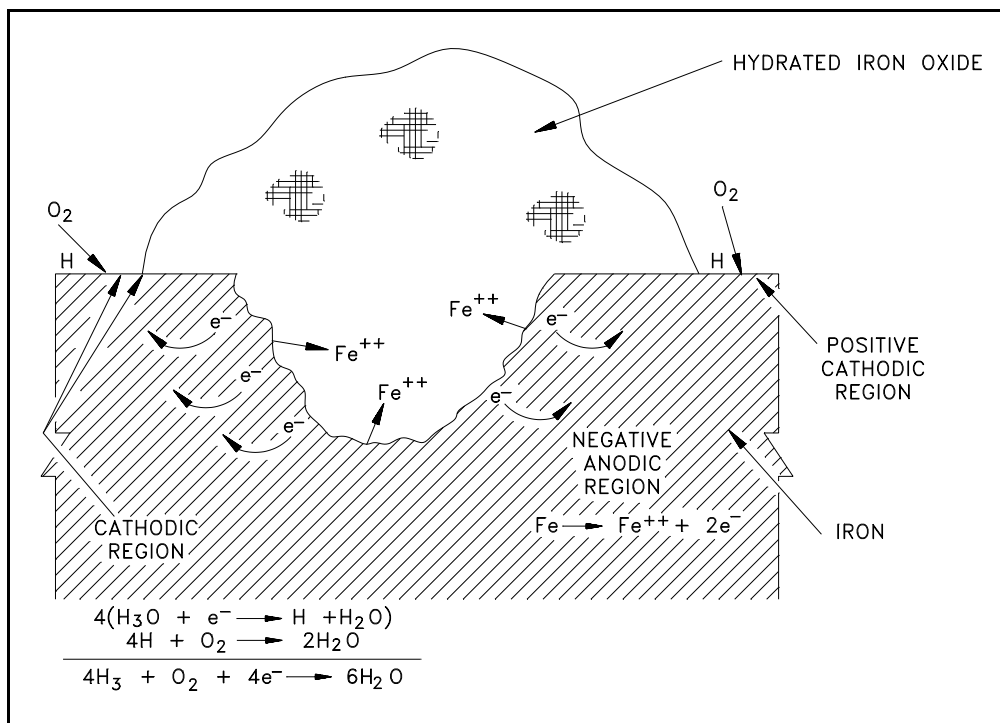

Figure 13 Pit in Metal Surface Promoted by Depolarization

It is also found that certain ions, notably chloride ions, cause pitting of iron and steel. The exact mechanism by which this occurs is not clear, but in some way chloride ions cause defects in the passivating oxide layer on the metal surface. The defects are highly localized and are surrounded by large passive areas that tend to be cathodic. Thus, a small anodic (oxidation) site is surrounded by a large cathodic (reduction) area. The current density will then be very large at the anodic site, and attack on the metal will be rapid. In some test cases, deep pits have been observed within a few hours.

Pitting and crevice corrosion are a major hazard to a nuclear facility because of the rapid penetration of the metal with little overall loss of mass. A nuclear facility minimizes pitting and crevice corrosion by the following actions.

- Avoiding stagnant or low flow conditions.
- Using metals and alloys that are less susceptible to the corrosion.
- Avoiding agents in the medium that cause pitting (for example, chlorides and oxygen).
- Designing the system and components such that no crevices are present.

### **Stress Corrosion Cracking**

*Stress corrosion cracking (SCC)* is a type of intergranular attack corrosion that occurs at the grain boundaries under tensile stress. Grain boundaries are discussed in detail in the *Material Science Handbook*. SCC occurs in susceptible alloys when the alloy is exposed to a particular, specific environment if the alloy is in a stressed condition. Stress corrosion cracking appears to be relatively independent of general uniform corrosion processes. Thus, the extent of general corrosion can be essentially nil, and stress cracking can still occur. Most pure metals are immune to this type of attack.

According to the most widely accepted theory, stress corrosion cracking is caused by a process called chemisorption. Unlike relatively weak physical absorption, such as hydrogen gas on platinum metal, chemisorption may be thought of as the formation of a compound between the metal atoms on the surface as a monomolecular layer of the chemisorbed substance, such as Cl<sup>-</sup>, OH<sup>-</sup>, Br<sup>-</sup>, and some other ions. The formation of this chemisorbed layer greatly reduces the attraction between neighboring metal atoms. A defect initially present then grows as the metal atoms separate under stress, more chemisorption occurs, and the process continues. In very severe cases, the time required for this cracking to occur is only a matter of minutes.

Many stainless steels are susceptible to stress corrosion cracking. Stainless steels containing 18 percent chromium and 8 percent nickel are susceptible to cracking in environments containing chloride ions and in concentrated caustic environments (that is, in environments where the hydroxyl ion concentration is high). On the other hand, these types of stainless steels do not exhibit any tendency to crack when they are exposed to water environments containing nitrate (NO<sub>3</sub><sup>-</sup>), sulfite (SO<sub>3</sub><sup>-</sup>), and ammonium (NH<sub>3</sub><sup>+</sup>) ions.

SCC is of great concern because it can readily crack metal of appreciable thickness. If the environment is severe enough, cracking can occur in a very short period of time. The crack can then lead to a serious failure of the component, or the system, and all the attendant results (for example, contamination, loss of coolant, and loss of pressure).

The most effective means for preventing SCC are proper design, reducing stress, removing critical environmental contributors (for example, hydroxides, chlorides, and oxygen), and avoiding stagnant areas and crevices in heat exchangers where chlorides and hydroxides might become concentrated. Low alloy steels are less susceptible than high alloy steels, but they are subject to SCC in water containing chloride ions. Nickel based alloys are not affected by chloride or hydroxide ions.

Two types of SCC are of major concern to a nuclear facility.

### **Chloride Stress Corrosion Cracking (Stainless Steels)**

The three conditions that must be present for chloride stress corrosion to occur are as follows.

- Chloride ions are present in the environment
- Dissolved oxygen is present in the environment
- Metal is under tensile stress

Austenitic stainless steel is a non-magnetic alloy consisting of iron, chromium, and nickel, with a low carbon content. This alloy is highly corrosion resistant and has desirable mechanical properties. One type of corrosion which can attack austenitic stainless steel is chloride stress corrosion. Chloride stress corrosion is a type of intergranular corrosion.

Chloride stress corrosion involves selective attack of the metal along grain boundaries. In the formation of the steel, a chromium-rich carbide precipitates at the grain boundaries leaving these areas low in protective chromium, and thereby, susceptible to attack. It has been found that this is closely associated with certain heat treatments resulting from welding. This can be minimized considerably by proper annealing processes.

This form of corrosion is controlled by maintaining low chloride ion and oxygen content in the environment and the use of low carbon steels. Environments containing dissolved oxygen and chloride ions can readily be created in auxiliary water systems. Chloride ions can enter these systems via leaks in condensers or at other locations where auxiliary systems associated with the nuclear facility are cooled by unpurified cooling water. Dissolved oxygen can readily enter these systems with feed and makeup water. Thus, chloride stress corrosion cracking is of concern, and controls must be used to prevent its occurrence.

Figure 14 illustrates intergranular stress corrosion cracking. The pressure of a tensile stress opens up intergranular cracks and accelerates further corrosion. Chloride stress corrosion is a particularly significant problem in the operation of nuclear facilities because of the wide use of austenitic stainless steel, and the inherent presence of high tensile stresses associated with pressurization. Chloride stress corrosion cracks have been known to propagate in austenitic stainless steel at stresses of about one-fifth yield strength with chloride concentrations of less than 50 ppm. Yield strength is discussed in detail in the *Material Science Handbook*.

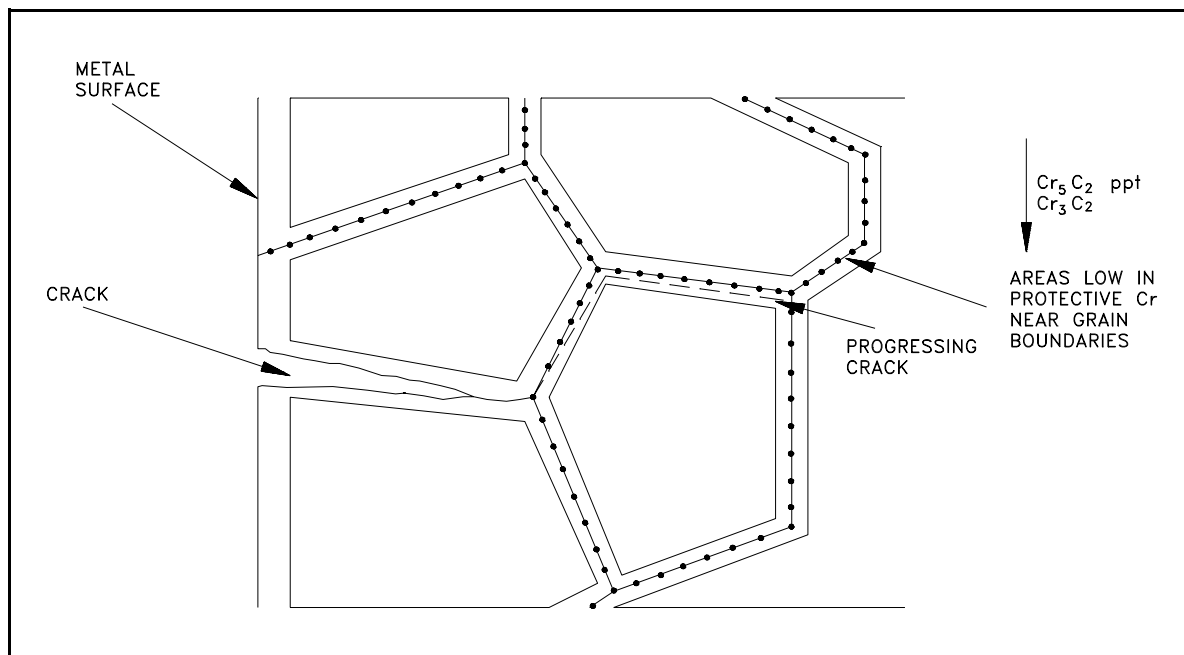

Figure 14 Intergranular Corrosion Cracking

Tests show that the 18-8 stainless steels are susceptible to chloride stress attack when both the chloride ion concentration and dissolved oxygen concentration are above certain values. The region of susceptibility for austenitic stainless steel is illustrated in Figure 15. Note that when dissolved oxygen is present at about 1 ppm, chloride stress corrosion cracking can be initiated at chloride ion concentrations near 1 ppm. However, when the concentration of dissolved oxygen is very low, susceptibility to chloride stress corrosion cracking is reduced.

High temperature tends to decrease the time required for chloride-induced cracking to occur, but there appears to be no practical temperature limit below which cracking will not occur, given sufficient time and severe conditions. The curve in Figure 15 is valid for temperatures in the range 470°F to 500°F.

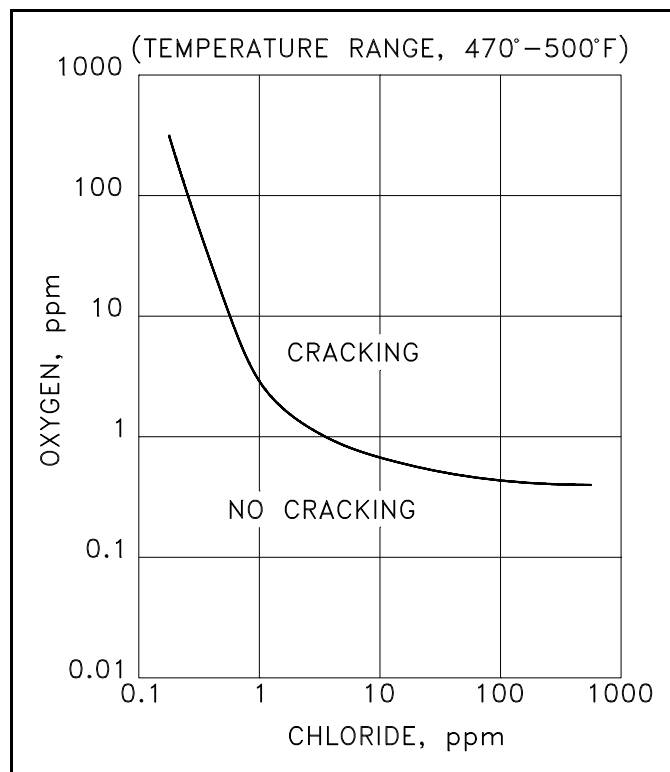

Figure 15 Austenitic Stainless Steel

### **Caustic Stress Corrosion Cracking**

Caustic stress corrosion, or caustic embrittlement, is another form of intergranular corrosion cracking. The mechanism is similar to that of chloride stress corrosion. Mild steels (steels with low carbon and low alloy content) and stainless steels will crack if they are exposed to concentrated caustic (high pH) environments with the metal under a tensile stress. In stress cracking that is induced by a caustic environment, the presence of dissolved oxygen is not necessary for the cracking to occur.

Caustic stress corrosion cracking was first encountered in the operation of riveted steam boilers. These boilers were found to fail on occasion along riveted seams. Failure was attributed to caustic-induced cracking at the highly stressed regions near and under the rivets. Boiler water could easily flow into the crevices which existed under the rivets.

Radiative heating would cause the water in the crevices to boil. As steam was formed, it would escape from the crevice. More boiler water would then flow into the crevice, boil, and pass from the crevice as steam. The net result of this continuing process was concentration of caustic under the rivet. The combination of high stress and high caustic concentrations eventually led to destructive cracking of the boiler vessel.



Where the rate of steam generation (boiling) is high, it is more difficult to eliminate the problem of solute concentration in regions of the boiler. Caustic stress corrosion may concentrate in such regions as the water evaporates rapidly, but sufficient concentration of caustic by such a mechanism to induce stress cracking is considered unlikely.

Available data indicates that caustic concentrations greater than 10,000 ppm, and probably up to 50,000 ppm, are required to induce caustic stress cracking (40,000 ppm NaOH is equivalent to 40 grams per liter or 1 mole per liter). The pH of such a solution is on the order of 14. An alkaline environment is produced and controlled by use of a solution having some properties of a buffer, that is, one that tends to retard or slow a reaction or tends to force it in one direction or the other.

## **Summary**

The important information of this chapter is summarized below.

### **Specialized Corrosion Summary**

- Pitting corrosion occurs where the anodic site becomes fixed in a small area and the formation of holes in an otherwise unaffected area takes place.
- Crevice corrosion is a type of pitting corrosion that occurs specifically within the low flow region of a crevice.
- Stress corrosion cracking (SCC) is a type of intergranular attack corrosion that occurs at the grain boundaries under tensile stress.
- Pitting corrosion requires two conditions to occur, low flow and areas of both high and low oxygen concentration. When these conditions are met a differential aeration cell is established which produces an electron flow from the point of low oxygen concentration to the area of high oxygen concentration. The difference in oxygen concentration is usually due to a low flow condition.
- Pitting corrosion is a hazard due to the possible rapid penetration of the metal with little overall loss of mass. Pitting corrosion is minimized by:

Avoiding stagnant conditions

Using the correct metals and alloys that are less susceptible to the corrosion

Avoiding agents in the medium that cause pitting

Designing the system and components such that no crevices are present

- Stress corrosion cracking occurs when three conditions are met; the alloy is susceptible to stress corrosion cracking, the alloy is exposed to specific environment, and the alloy is in a stressed condition.
- Chemisorption is the formation of a monomolecular layer of a compound between the metal's surface atoms. This layer separates the metal's atoms thereby weakening the metal and allowing any existing defects to propagate when a stress is applied.

### Specialized Corrosion Summary (Cont.)

- Stress corrosion cracking (SCC) is a great concern due to the hazard that it can readily crack metal of appreciable thickness. The crack can lead to a serious failure of the component, or system, and all the attendant results such as:

- Contamination
  - Loss of coolant
  - Loss of pressure

- SCC is prevented in reactor system by:

- Proper design

- Reducing stress levels

- Avoiding stagnant areas and crevices in heat exchangers, where chlorides and hydroxides might become concentrated.

- Chloride stress corrosion

The three conditions that must be present for chloride stress corrosion to occur are:

- Chloride ions present
  - Dissolved oxygen present
  - Metal under tensile stress

Chloride stress corrosion is controlled by maintaining low chloride ion and oxygen content in the environment and the use of low carbon steels.

- Caustic stress corrosion

Caustic stress corrosion is similar to chloride stress corrosion. The metals involved are mild steels (steel with low carbon and low alloy content). The metals are exposed to concentrated caustic environments and under tensile stress. The presence of oxygen is not required for cracking to initiate. Concentration of greater than 10,000 ppm is required for cracking to initiate. The level may be higher for different caustic environments.

Intentionally Left Blank.