

DOE-HDBK-1018/1-93
JANUARY 1993

DOE FUNDAMENTALS HANDBOOK

MECHANICAL SCIENCE

Volume 1 of 2



U.S. Department of Energy
Washington, D.C. 20585

FSC-6910

Distribution Statement A. Approved for public release; distribution is unlimited.

MASTER

THIS DOCUMENT IS UNCLASSIFIED

ABSTRACT

The *Mechanical Science* Handbook was developed to assist nuclear facility operating contractors in providing operators, maintenance personnel, and the technical staff with the necessary fundamentals training to ensure a basic understanding of mechanical components and mechanical science. The handbook includes information on diesel engines, heat exchangers, pumps, valves, and miscellaneous mechanical components. This information will provide personnel with a foundation for understanding the construction and operation of mechanical components that are associated with various DOE nuclear facility operations and maintenance.

Key Words: Training Material, Diesel Engin., Heat Exchangers, Pumps, Valves

FOREWORD

The *Department of Energy (DOE) Fundamentals Handbooks* consist of ten academic subjects, which include Mathematics; Classical Physics; Thermodynamics, Heat Transfer, and Fluid Flow; Instrumentation and Control; Electrical Science; Material Science; Mechanical Science; Chemistry; Engineering Symbolology, Prints, and Drawings; and Nuclear Physics and Reactor Theory. The handbooks are provided as an aid to DOE nuclear facility contractors.

These handbooks were first published as Reactor Operator Fundamentals Manuals in 1985 for use by DOE category A reactors. The subject areas, subject matter content, and level of detail of the Reactor Operator Fundamentals Manuals were determined from several sources. DOE Category A reactor training managers determined which materials should be included, and served as a primary reference in the initial development phase. Training guidelines from the commercial nuclear power industry, results of job and task analyses, and independent input from contractors and operations-oriented personnel were all considered and included to some degree in developing the text material and learning objectives.

The *DOE Fundamentals Handbooks* represent the needs of various DOE nuclear facilities' fundamental training requirements. To increase their applicability to nonreactor nuclear facilities, the Reactor Operator Fundamentals Manual learning objectives were distributed to the Nuclear Facility Training Coordination Program Steering Committee for review and comment. To update their reactor-specific content, DOE Category A reactor training managers also reviewed and commented on the content. On the basis of feedback from these sources, information that applied to two or more DOE nuclear facilities was considered generic and was included. The final draft of each of the handbooks was then reviewed by these two groups. This approach has resulted in revised modular handbooks that contain sufficient detail such that each facility may adjust the content to fit their specific needs.

Each handbook contains an abstract, a foreword, an overview, learning objectives, and text material, and is divided into modules so that content and order may be modified by individual DOE contractors to suit their specific training needs. Each handbook is supported by a separate examination bank with an answer key.

The *DOE Fundamentals Handbooks* have been prepared for the Assistant Secretary for Nuclear Energy, Office of Nuclear Safety Policy and Standards, by the DOE Training Coordination Program. This program is managed by EG&G Idaho, Inc.

OVERVIEW

The *Department of Energy Fundamentals Handbook* entitled *Mechanical Science* was prepared as an information resource for personnel who are responsible for the operation of the Department's nuclear facilities. Almost all processes that take place in the nuclear facilities involve the use of mechanical equipment and components. A basic understanding of mechanical science is necessary for DOE nuclear facility operators, maintenance personnel, and the technical staff to safely operate and maintain the facility and facility support systems. The information in the handbook is presented to provide a foundation for applying engineering concepts to the job. This knowledge will help personnel more fully understand the impact that their actions may have on the safe and reliable operation of facility components and systems.

The *Mechanical Science* handbook consists of five modules that are contained in two volumes. The following is a brief description of the information presented in each module of the handbook.

Volume 1 of 2

Module 1 - Diesel Engine Fundamentals

Provides information covering the basic operating principles of 2-cycle and 4-cycle diesel engines. Includes operation of engine governors, fuel ejectors, and typical engine protective features.

Module 2 - Heat Exchangers

Describes the construction of plate heat exchangers and tube and shell heat exchangers. Describes the flow patterns and temperature profiles in parallel flow, counter flow, and cross flow heat exchangers.

Module 3 - Pumps

Explains the operation of centrifugal and positive displacement pumps. Topics include net positive suction head, cavitation, gas binding, and pump characteristic curves.

OVERVIEW (Cont.)

Volume 2 of 2

Module 4 - Valves

Introduces the functions of the basic parts common to most types of valves. Provides information on applications of many types of valves. Types of valves covered include gate valves, globe valves, ball valves, plug valves, diaphragm valves, reducing valves, pinch valves, butterfly valves, needle valves, check valves, and safety/relief valves.

Module 5 - Miscellaneous Mechanical Components

Provides information on significant mechanical devices that have widespread application in nuclear facilities but do not fit into the categories of components covered by the other modules. These include cooling towers, air compressors, demineralizers, filters, strainers, etc.

The information contained in this handbook is not all-encompassing. An attempt to present the entire subject of mechanical science would be impractical. However, the *Mechanical Science* handbook presents enough information to provide the reader with the fundamental knowledge necessary to understand the advanced theoretical concepts presented in other subject areas, and to understand basic system and equipment operation.

**Department of Energy
Fundamentals Handbook**

**MECHANICAL SCIENCE
Module 1
Diesel Engine Fundamentals**

TABLE OF CONTENTS

LIST OF FIGURES	ii
LIST OF TABLES	iv
REFERENCES	v
OBJECTIVES	vi
DIESEL ENGINES	1
Introduction	1
History	2
Diesel Engines	2
Major Components of a Diesel Engine	3
Diesel Engine Support Systems	12
Exhaust System	16
Operational Terminology	17
Summary	20
FUNDAMENTALS OF THE DIESEL CYCLE	21
The Basic Diesel Cycles	21
The Four-Stroke Cycle	22
The Two-Stroke Cycle	25
Summary	28
DIESEL ENGINE SPEED, FUEL CONTROLS, AND PROTECTION	30
Engine Control	30
Fuel Injectors	30
Governor	34
Operation of a Governor	34
Starting Circuits	38
Engine Protection	38
Summary	40

LIST OF FIGURES

Figure 1	Example of a Large Skid-Mounted, Diesel-Driven Generator	2
Figure 2	Cutaway of a Four-Stroke Supercharged Diesel Engine	4
Figure 3	Cross Section of a V-type Four Stroke Diesel Engine	5
Figure 4	The Cylinder Block	6
Figure 5	Diesel Engine Wet Cylinder Sleeve	7
Figure 6	Piston and Piston Rod	7
Figure 7	Diesel Engine Crankshaft and Bearings	9
Figure 8	Diesel Engine Valve	10
Figure 9	Diesel Engine Camshaft and Drive Gear	10
Figure 10	Diesel Engine Valve Train	11
Figure 11	Diesel Engine Cooling System	12
Figure 12	Diesel Engine Internal Lubrication System	13
Figure 13	Diesel Engine Fuel Flowpath	14
Figure 14	Oil Bath Air Filter	15
Figure 15	Compression Ratio	18
Figure 16	Scavenging and Intake	22
Figure 17	Compression	23
Figure 18	Fuel Injection	24
Figure 19	Power	24
Figure 20	Exhaust	25
Figure 21	2-Stroke Exhaust	26

LIST OF FIGURES (Cont.)

Figure 22 2-Stroke Intake	26
Figure 23 2-Stroke Compression	27
Figure 24 2-Stroke Fuel Injection	27
Figure 25 2-Stroke Power	27
Figure 26 Fuel Injector Cutaway	31
Figure 27 Fuel Injector Plunger	33
Figure 28 Simplified Mechanical-Hydraulic Governor	35
Figure 29 Cutaway of a Woodward Governor	36

LIST OF TABLES

- NONE

REFERENCES

- Benson & Whitehouse, Internal Combustion Engines, Pergamon.
- Cheremisinoff, N. P., Fluid Flow, Pumps, Pipes and Channels, Ann Arbor Science.
- Scheel, Gas and Air Compression Machinery, McGraw/Hill.
- Skrotzki and Vopat, Steam and Gas Turbines, McGraw/Hill.
- Stinson, Karl W., Diesel Engineering Handbook, Diesel Publications Incorporated.

TERMINAL OBJECTIVE

- 1.0 Without references, **DESCRIBE** the components and theory of operation for a diesel engine.

ENABLING OBJECTIVES

- 1.1 **DEFINE** the following diesel engine terms:
- a. Compression ratio
 - b. Bore
 - c. Stroke
 - d. Combustion chamber
- 1.2 Given a drawing of a diesel engine, **IDENTIFY** the following:
- a. Piston/rod
 - b. Cylinder
 - c. Blower
 - d. Crankshaft
 - e. Intake ports or valve(s)
 - f. Exhaust ports or valve(s)
 - g. Fuel injector
- 1.3 **EXPLAIN** how a diesel engine converts the chemical energy stored in the diesel fuel into mechanical energy.
- 1.4 **EXPLAIN** how the ignition process occurs in a diesel engine.
- 1.5 **EXPLAIN** the operation of a 4-cycle diesel engine to include when the following events occur during a cycle:
- a. Intake
 - b. Exhaust
 - c. Fuel injection
 - d. Compression
 - e. Power

ENABLING OBJECTIVES (Cont.)

- 1.6 **EXPLAIN** the operation of a 2-cycle diesel engine, including when the following events occur during a cycle:
- a. Intake
 - b. Exhaust
 - c. Fuel injection
 - d. Compression
 - e. Power
- 1.7 **DESCRIBE** how the mechanical-hydraulic governor on a diesel engine controls engine speed.
- 1.8 **LIST** five protective alarms usually found on mid-sized and larger diesel engines.

Intentionally Left Blank

DIESEL ENGINES

One of the most common prime movers is the diesel engine. Before gaining an understanding of how the engine operates a basic understanding of the engine's components must be gained. This chapter reviews the major components of a generic diesel engine.

EO 1.1 **DEFINE** the following diesel engine terms:

- a. **Compression ratio**
- b. **Bore**
- c. **Stroke**
- d. **Combustion chamber**

EO 1.2 **Given a drawing of a diesel engine, IDENTIFY** the following:

- | | |
|----------------------|-------------------------------------|
| a. Piston/rod | e. Intake ports or valve(s) |
| b. Cylinder | f. Exhaust ports or valve(s) |
| c. Blower | g. Fuel injector |
| d. Crankshaft | |

Introduction

Most DOE facilities require some type of prime mover to supply mechanical power for pumping, electrical power generation, operation of heavy equipment, and to act as a backup electrical generator for emergency use during the loss of the normal power source. Although several types of prime movers are available (gasoline engines, steam and gas turbines), the diesel engine is the most commonly used. Diesel engines provide a self-reliant energy source that is available in sizes from a few horsepower to 10,000 hp. Figure 1 provides an illustration of a common skid-mounted, diesel-driven generator. Relatively speaking, diesel engines are small, inexpensive, powerful, fuel efficient, and extremely reliable if maintained properly.

Because of the widespread use of diesel engines at DOE facilities, a basic understanding of the operation of a diesel engine will help ensure they are operated and maintained properly. Due to the large variety of sizes, brands, and types of engines in service, this module is intended to provide the fundamentals and theory of operation of a diesel engine. Specific information on a particular engine should be obtained from the vendor's manual.

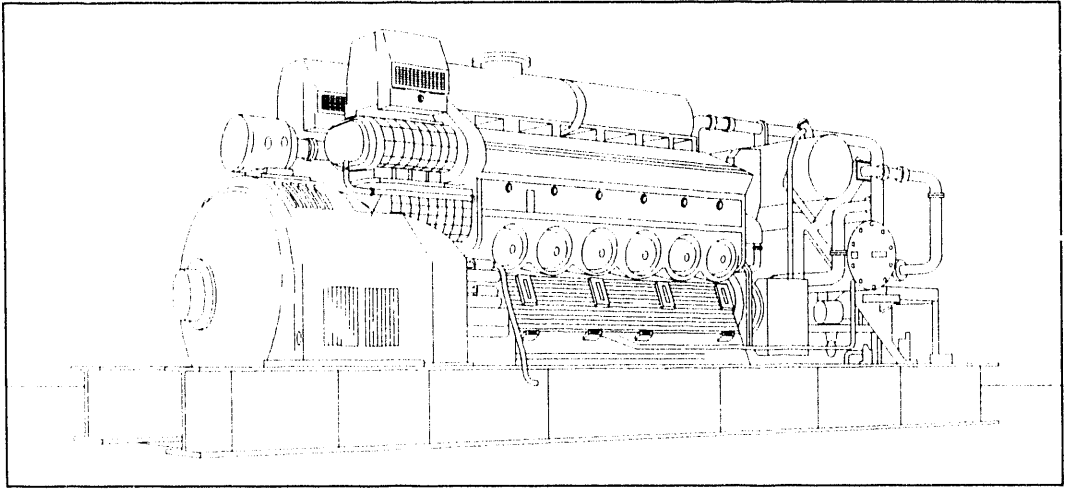

Figure 1 Example of a Large Skid-Mounted, Diesel-Driven Generator

History

The modern diesel engine came about as the result of the internal combustion principles first proposed by Sadi Carnot in the early 19th century. Dr. Rudolf Diesel applied Sadi Carnot's principles into a patented cycle or method of combustion that has become known as the "diesel" cycle. His patented engine operated when the heat generated during the compression of the air fuel charge caused ignition of the mixture, which then expanded at a constant pressure during the full power stroke of the engine.

Dr. Diesel's first engine ran on coal dust and used a compression pressure of 1500 psi to increase its theoretical efficiency. Also, his first engine did not have provisions for any type of cooling system. Consequently, between the extreme pressure and the lack of cooling, the engine exploded and almost killed its inventor. After recovering from his injuries, Diesel tried again using oil as the fuel, adding a cooling water jacket around the cylinder, and lowering the compression pressure to approximately 550 psi. This combination eventually proved successful. Production rights to the engine were sold to Adolphus Bush, who built the first diesel engines for commercial use, installing them in his St. Louis brewery to drive various pumps.

Diesel Engines

A diesel engine is similar to the gasoline engine used in most cars. Both engines are internal combustion engines, meaning they burn the fuel-air mixture within the cylinders. Both are reciprocating engines, being driven by pistons moving laterally in two directions. The majority of their parts are similar. Although a diesel engine and gasoline engine operate with similar components, a diesel engine, when compared to a gasoline engine of equal horsepower, is heavier due to stronger, heavier materials used to withstand the greater dynamic forces from the higher combustion pressures present in the diesel engine.

The greater combustion pressure is the result of the higher compression ratio used by diesel engines. The *compression ratio* is a measure of how much the engine compresses the gasses in the engine's cylinder. In a gasoline engine the compression ratio (which controls the compression temperature) is limited by the air-fuel mixture entering the cylinders. The lower ignition temperature of gasoline will cause it to ignite (burn) at a compression ratio of less than 10:1. The average car has a 7:1 compression ratio. In a diesel engine, compression ratios ranging from 14:1 to as high as 24:1 are commonly used. The higher compression ratios are possible because only air is compressed, and then the fuel is injected. This is one of the factors that allows the diesel engine to be so efficient. Compression ratio will be discussed in greater detail later in this module.

Another difference between a gasoline engine and a diesel engine is the manner in which engine speed is controlled. In any engine, speed (or power) is a direct function of the amount of fuel burned in the cylinders. Gasoline engines are self-speed-limiting, due to the method the engine uses to control the amount of air entering the engine. Engine speed is indirectly controlled by the butterfly valve in the carburetor. The butterfly valve in a carburetor limits the amount of air entering the engine. In a carburetor, the rate of air flow dictates the amount of gasoline that will be mixed with the air. Limiting the amount of air entering the engine limits the amount of fuel entering the engine, and, therefore, limits the speed of the engine. By limiting the amount of air entering the engine, adding more fuel does not increase engine speed beyond the point where the fuel burns 100% of the available air (oxygen).

Diesel engines are not self-speed-limiting because the air (oxygen) entering the engine is always the maximum amount. Therefore, the engine speed is limited solely by the amount of fuel injected into the engine cylinders. Therefore, the engine always has sufficient oxygen to burn and the engine will attempt to accelerate to meet the new fuel injection rate. Because of this, a manual fuel control is not possible because these engines, in an unloaded condition, can accelerate at a rate of more than 2000 revolutions per second. Diesel engines require a speed limiter, commonly called the governor, to control the amount of fuel being injected into the engine.

Unlike a gasoline engine, a diesel engine does not require an ignition system because in a diesel engine the fuel is injected into the cylinder as the piston comes to the top of its compression stroke. When fuel is injected, it vaporizes and ignites due to the heat created by the compression of the air in the cylinder.

Major Components of a Diesel Engine

To understand how a diesel engine operates, an understanding of the major components and how they work together is necessary. Figure 2 is an example of a medium-sized, four-stroke, supercharged, diesel engine with inlet ports and exhaust valves. Figure 3 provides a cross section of a similarly sized V-type diesel engine.

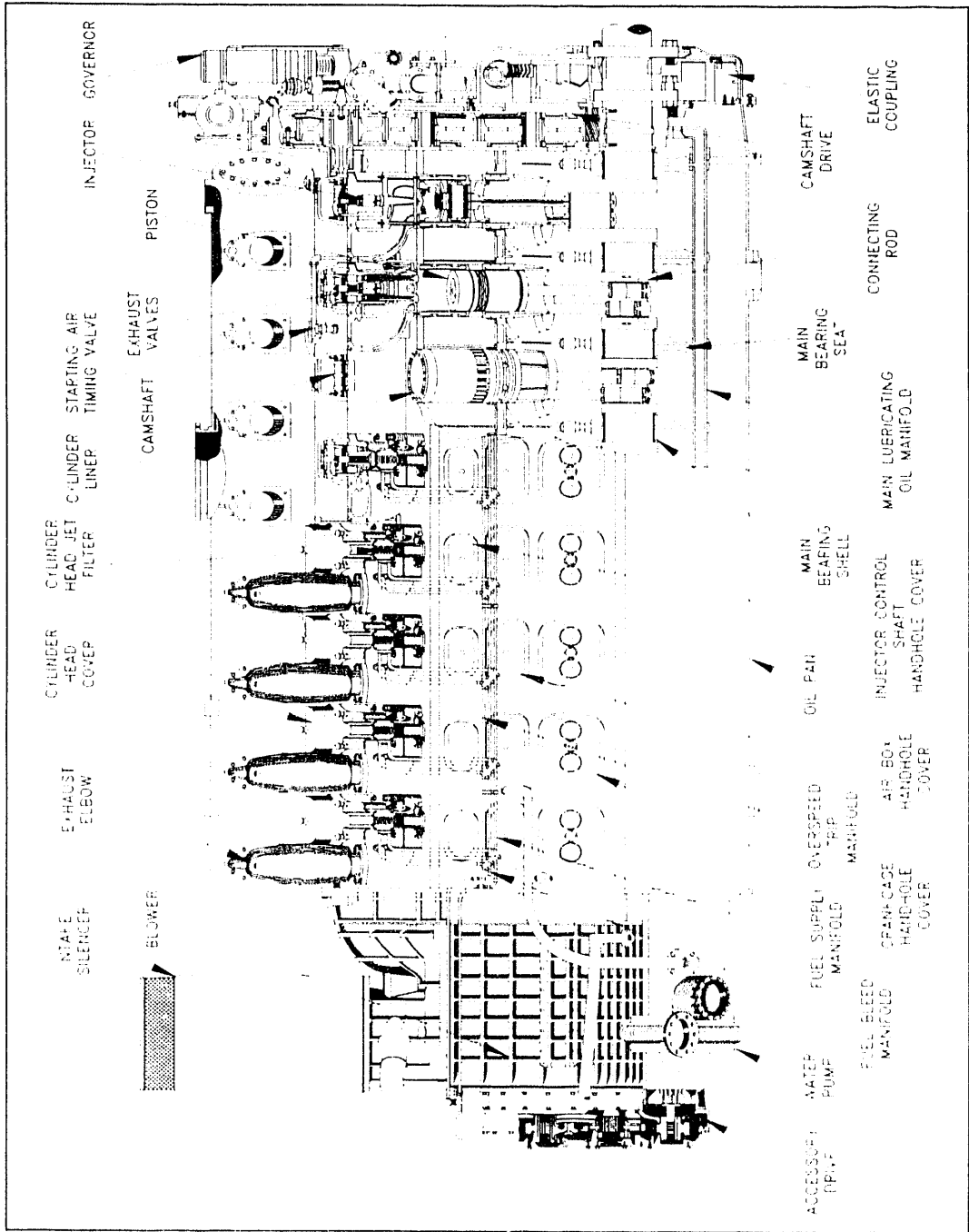

Figure 2 Cutaway of a GM V-16 Four-Stroke Supercharged Diesel Engine

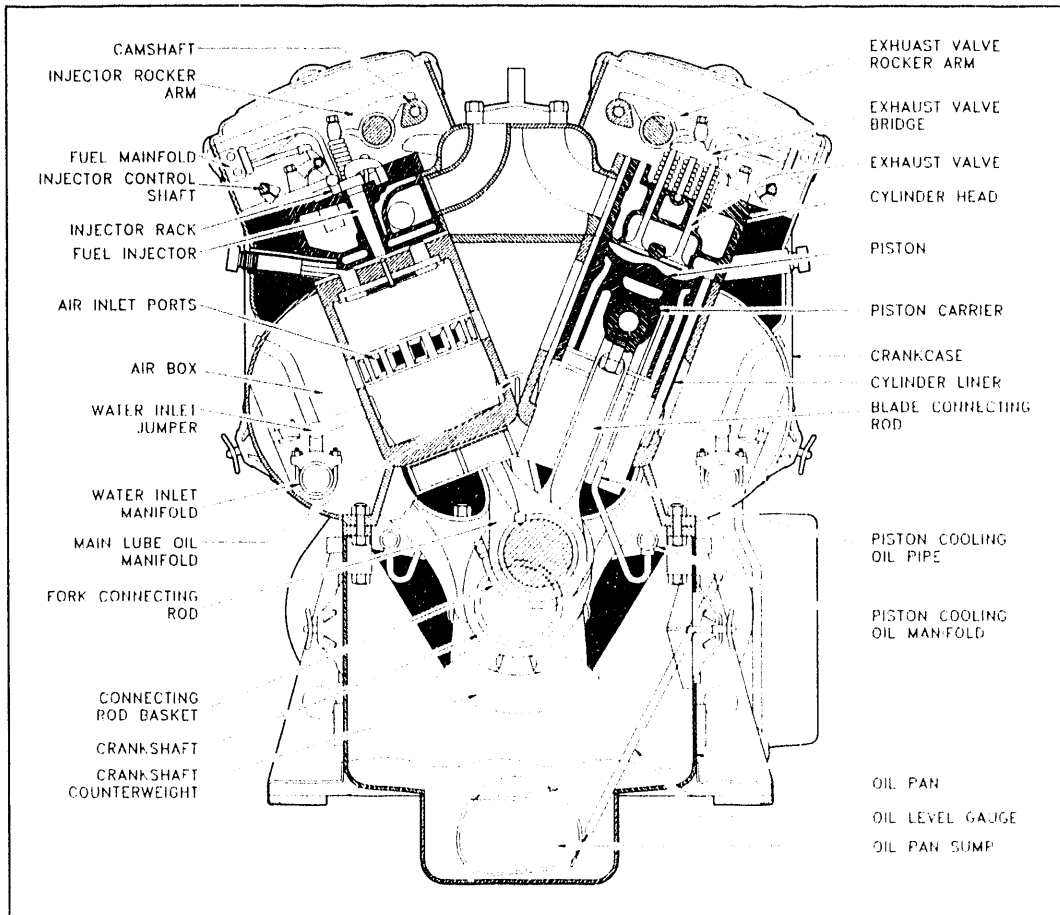

Figure 3 Cross Section of a V-type Four Stroke Diesel Engine

The Cylinder Block

The cylinder block, as shown in Figure 4, is generally a single unit made from cast iron. In a liquid-cooled diesel, the block also provides the structure and rigid frame for the engine's cylinders, water coolant and oil passages, and support for the crankshaft and camshaft bearings.

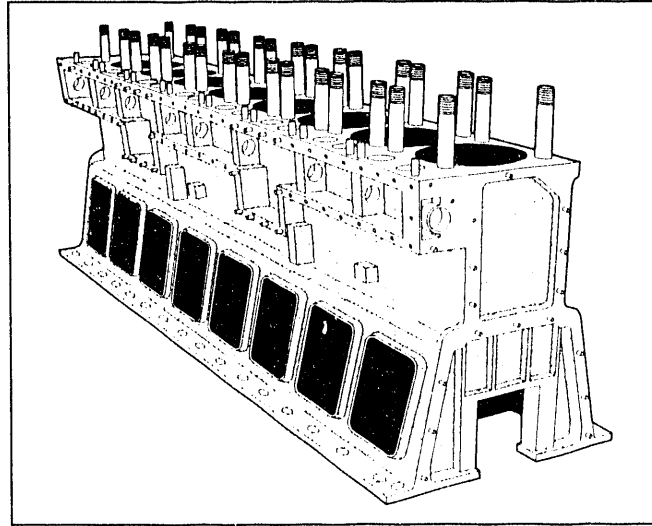

Figure 4 The Cylinder Block

Crankcase and Oil Pan

The *crankcase* is usually located on the bottom of the cylinder block. The crankcase is defined as the area around the crankshaft and crankshaft bearings. This area encloses the rotating crankshaft and crankshaft counter weights and directs returning oil into the oil pan. The oil pan is located at the bottom of the crankcase as shown in Figure 2 and Figure 3. The *oil pan* collects and stores the engine's supply of lubricating oil. Large diesel engines may have the oil pan divided into several separate pans.

Cylinder Sleeve or Bore

Diesel engines use one of two types of cylinders. In one type, each cylinder is simply machined or bored into the block casting, making the block and cylinders an integral part. In the second type, a machined steel sleeve is pressed into the block casting to form the cylinder. Figure 2 and Figure 3 provide examples of sleeved diesel engines. With either method, the *cylinder sleeve* or *bore* provides the engine with the cylindrical structure needed to confine the combustion gasses and to act as a guide for the engine's pistons.

In engines using sleeves, there are two types of sleeves, wet and dry. A dry sleeve is surrounded by the metal of the block and does not come in direct contact with the engine's coolant (water). A wet sleeve comes in direct contact with the engine's coolant. Figure 5 provides an example of a wet sleeve. The volume enclosed by the sleeve or bore is called the combustion chamber and is the space where the fuel is burned.

In either type of cylinder, sleeved or bored, the diameter of the cylinder is called the bore of the engine and is stated in inches. For example, the bore of a 350 cubic inch Chevrolet gasoline engine is 4 inches.

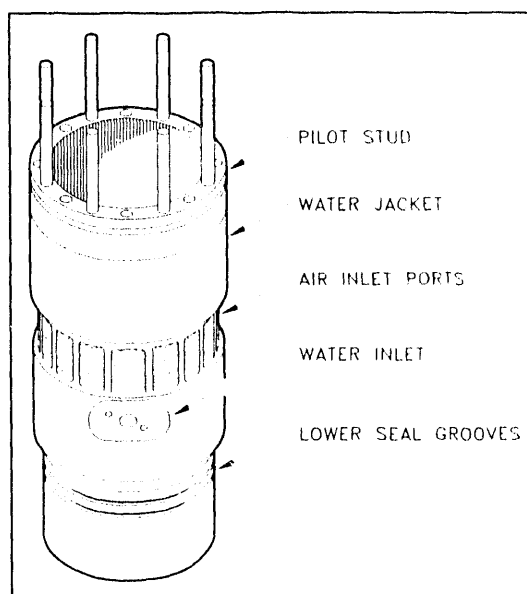

Figure 5 Diesel Engine Wet Cylinder Sleeve

Most diesel engines are multi-cylinder engines and typically have their cylinders arranged in one of two ways, an in-line or a "V", although other combinations exist. In an in-line engine, as the name indicates, all the cylinders are in a row. In a "V" type engine the cylinders are arranged in two rows of cylinders set at an angle to each other that align to a common crankshaft. Each group of cylinders making up one side of the "V" is referred to as a bank of cylinders.

Piston and Piston Rings

The *piston* transforms the energy of the expanding gasses into mechanical energy. The piston rides in the cylinder liner or sleeve as shown in Figure 2 and Figure 3. Pistons are commonly made of aluminum or cast iron alloys.

To prevent the combustion gasses from bypassing the piston and to keep friction to a minimum, each piston has several metal rings around it, as illustrated by Figure 6.

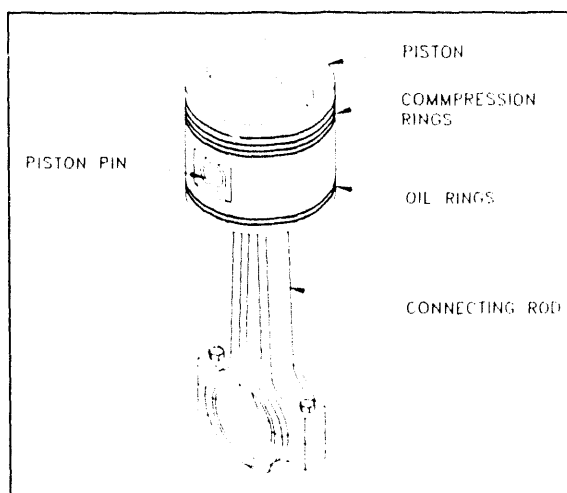

Figure 6 Piston and Piston Rod

These rings function as the seal between the piston and the cylinder wall and also act to reduce friction by minimizing the contact area between the piston and the cylinder wall. The rings are usually made of cast iron and coated with chrome or molybdenum. Most diesel engine pistons have several rings, usually 2 to 5, with each ring performing a distinct function. The top ring(s) acts primarily as the pressure seal. The intermediate ring(s) acts as a wiper ring to remove and control the amount of oil film on the cylinder walls. The bottom ring(s) is an oiler ring and ensures that a supply of lubricating oil is evenly deposited on the cylinder walls.

Connecting Rod

The *connecting rod* connects the piston to the crankshaft. See Figure 2 and Figure 3 for the location of the connecting rods in an engine. The rods are made from drop-forged, heat-treated steel to provide the required strength. Each end of the rod is bored, with the smaller top bore connecting to the piston pin (wrist pin) in the piston as shown in Figure 6. The large bore end of the rod is split in half and bolted to allow the rod to be attached to the crankshaft. Some diesel engine connecting rods are drilled down the center to allow oil to travel up from the crankshaft and into the piston pin and piston for lubrication.

A variation found in V-type engines that affects the connecting rods is to position the cylinders in the left and right banks directly opposite each other instead of staggered (most common configuration). This arrangement requires that the connecting rods of two opposing cylinders share the same main journal bearing on the crankshaft. To allow this configuration, one of the connecting rods must be split or forked around the other.

Crankshaft

The *crankshaft* transforms the linear motion of the pistons into a rotational motion that is transmitted to the load. Crankshafts are made of forged steel. The forged crankshaft is machined to produce the crankshaft bearing and connecting rod bearing surfaces. The rod bearings are eccentric, or offset, from the center of the crankshaft as illustrated in Figure 7. This offset converts the reciprocating (up and down) motion of the piston into the rotary motion of the crankshaft. The amount of offset determines the stroke (distance the piston travels) of the engine (discussed later).

The crankshaft does not ride directly on the cast iron block crankshaft supports, but rides on special bearing material as shown in Figure 7. The connecting rods also have bearings inserted between the crankshaft and the connecting rods. The bearing material is a soft alloy of metals that provides a replaceable wear surface and prevents galling between two similar metals (i.e., crankshaft and connecting rod). Each bearing is split into halves to allow assembly of the engine. The crankshaft is drilled with oil passages that allow the engine to feed oil to each of the crankshaft bearings and connection rod bearings and up into the connecting rod itself.

The crankshaft has large weights, called counter weights, that balance the weight of the connecting rods. These weights ensure an even (balance) force during the rotation of the moving parts.

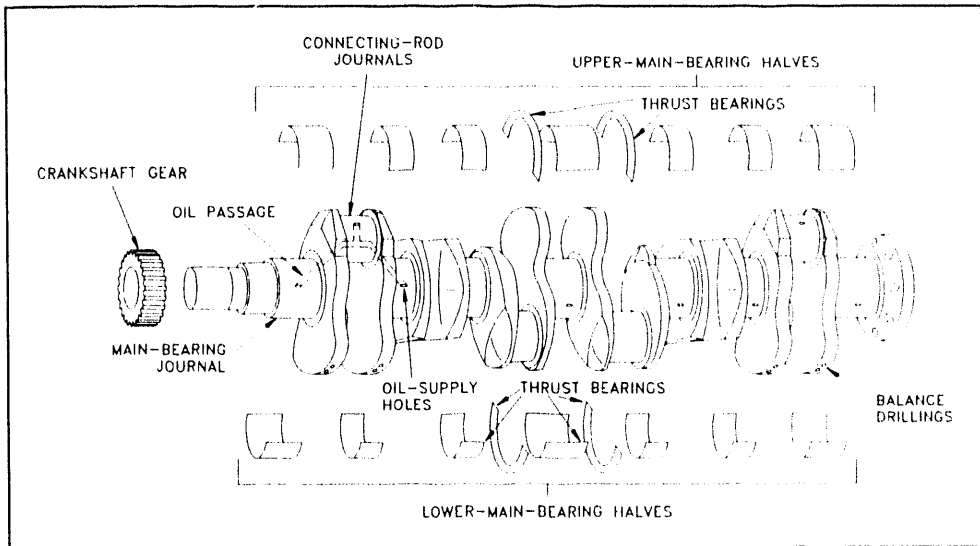

Figure 7 Diesel Engine Crankshaft and Bearings

Flywheel

The *flywheel* is located on one end of the crankshaft and serves three purposes. First, through its inertia, it reduces vibration by smoothing out the power stroke as each cylinder fires. Second, it is the mounting surface used to bolt the engine up to its load. Third, on some diesels, the flywheel has gear teeth around its perimeter that allow the starting motors to engage and crank the diesel.

Cylinder Heads and Valves

A diesel engine's *cylinder heads* perform several functions. First, they provide the top seal for the cylinder bore or sleeve. Second, they provide the structure holding exhaust valves (and intake valves where applicable), the fuel injector, and necessary linkages. A diesel engine's heads are manufactured in one of two ways. In one method, each cylinder has its own head casting, which is bolted to the block. This method is used primarily on the larger diesel engines. In the second method, which is used on smaller engines, the engine's head is cast as one piece (multi-cylinder head).

Diesel engines have two methods of admitting and exhausting gasses from the cylinder. They can use either ports or valves or a combination of both. *Ports* are slots in the cylinder walls located in the lower 1/3 of the bore. See Figure 2 and Figure 3 for examples of intake ports, and note their relative location with respect to the rest of the

engine. When the piston travels below the level of the ports, the ports are "opened" and fresh air or exhaust gasses are able to enter or leave, depending on the type of port.

The ports are then "closed" when the piston travels back above the level of the ports. *Valves* (refer to figure 8) are mechanically opened and closed to admit or exhaust the gasses as needed. The valves are located in the head casting of the engine. The point at which the valve seals against the head is called the *valve seat*. Most medium-sized diesels have either intake ports or exhaust valves or both intake and exhaust valves.

Timing Gears, Camshaft, and Valve Mechanism

In order for a diesel engine to operate, all of its components must perform their functions at very precise intervals in relation to the motion of the piston. To accomplish this, a component called a *camshaft* is used. Figure 9 illustrates a camshaft and camshaft drive gear. Figure 2 and Figure 3 illustrate the location of a camshaft in a large overhead cam diesel engine.

A camshaft is a long bar with egg-shaped eccentric lobes, one lobe for each valve and fuel injector (discussed later). Each lobe has a follower as shown on Figure 10. As the camshaft is rotated, the follower is forced up and down as it follows the profile of the cam lobe. The followers are connected to the engine's valves and fuel injectors through various types of linkages called *pushrods* and *rocker arms*. The

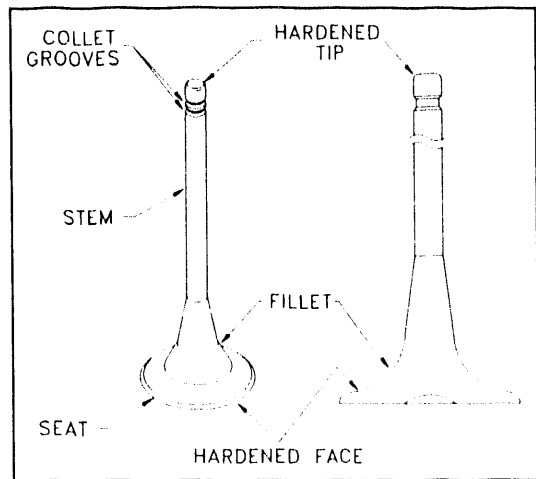

Figure 8 Diesel Engine Valve

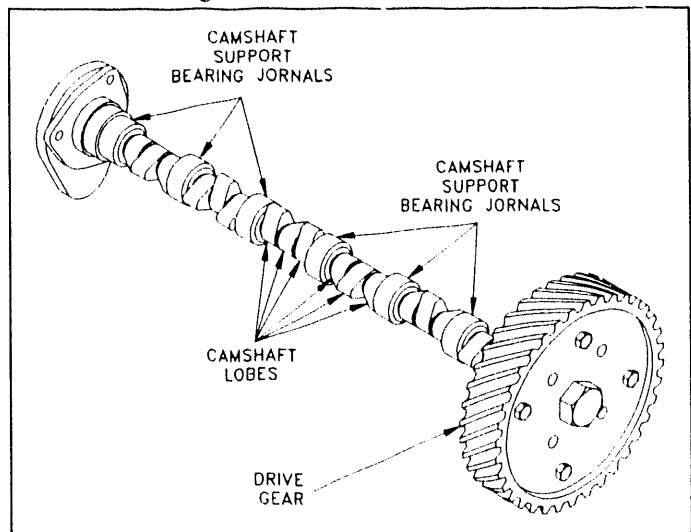

Figure 9 Diesel Engine Camshaft and Drive Gear

pushrods and rocker arms transfer the reciprocating motion generated by the camshaft lobes to the valves and injectors, opening and closing them as needed. The valves are maintained closed by springs.

As the valve is opened by the camshaft, it compresses the valve spring. The energy stored in the valve spring is then used to close the valve as the camshaft lobe rotates out from under the follower. Because an engine experiences fairly large changes in temperature (e.g., ambient to a normal running temperature of about 190°F), its components must be designed to allow for thermal expansion. Therefore, the valves, valve pushrods, and rocker arms must have some method of allowing for the expansion. This is accomplished by the use of valve lash. *Valve lash* is the term given to the "slop" or "give" in the valve train before the cam actually starts to open the valve.

The camshaft is driven by the engine's crankshaft through a series of gears called idler gears and timing gears. The gears allow the rotation of the camshaft to correspond or be in time with the rotation of the crankshaft and thereby allows the valve opening, valve closing, and injection of fuel to be timed to occur at precise intervals in the piston's travel. To increase the flexibility in timing the valve opening, valve closing, and injection of fuel, and to increase power or to reduce cost, an engine may have one or more camshafts.

Typically, in a medium to large V-type engine, each bank will have one or more camshafts per head. In the larger engines, the intake valves, exhaust valves, and fuel injectors may share a common camshaft or have independent camshafts.

Depending on the type and make of the engine, the location of the camshaft or shafts varies. The camshaft(s) in an in-line engine is usually found either in the head of the engine or in the top of the block running down one side of the cylinder bank. Figure 10 provides an example of an engine with the camshaft located on the side of the engine. Figure 3 provides an example of an overhead cam arrangement as on a V-type engine. On small or mid-sized V-type engines, the camshaft is usually located in the block at the

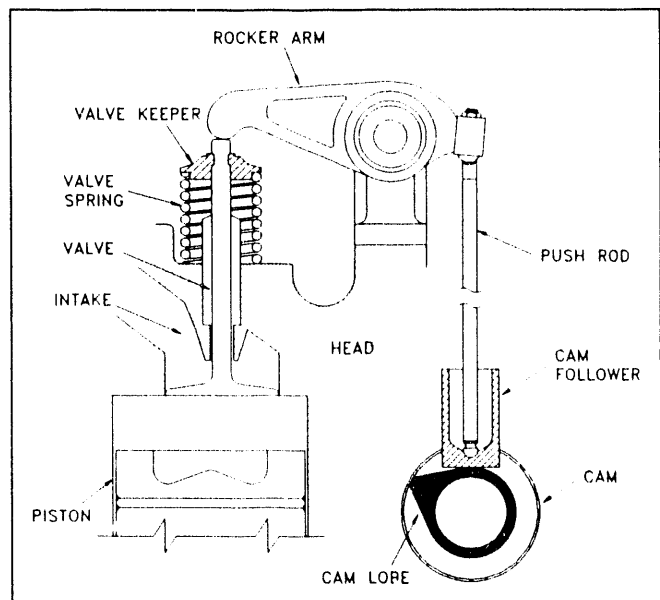

Figure 10 Diesel Engine Valve Train

center of the "V" between the two banks of cylinders. In larger or multi-camshafted V-type engines, the camshafts are usually located in the heads.

Blower

The diesel engine's *blower* is part of the air intake system and serves to compress the incoming fresh air for delivery to the cylinders for combustion. The location of the blower is shown on Figure 2. The blower can be part of either a turbocharged or supercharged air intake system. Additional information on these two types of blowers is provided later in this module.

Diesel Engine Support Systems

A diesel engine requires five supporting systems in order to operate: cooling, lubrication, fuel injection, air intake, and exhaust. Depending on the size, power, and application of the diesel, these systems vary in size and complexity.

Engine Cooling

Nearly all diesel engines rely on a liquid cooling system to transfer waste heat out of the block and internals as shown in Figure 11. The cooling system consists of a closed loop similar to that of a car engine and contains the following major components: water pump, radiator or heat exchanger, water jacket (which consists of coolant passages in the block and heads), and a thermostat.

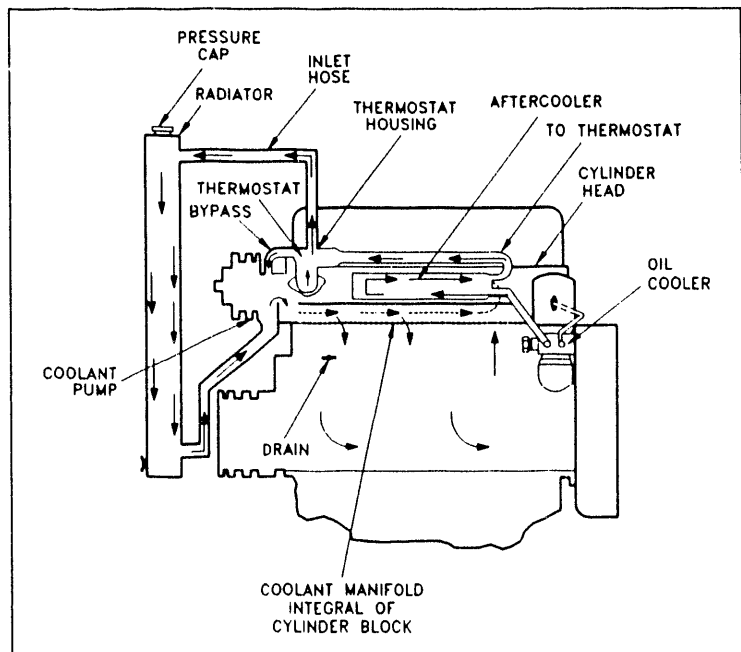

Figure 11 Diesel Engine Cooling System

Engine Lubrication

An internal combustion engine would not run for even a few minutes if the moving parts were allowed to make metal-to-metal contact. The heat generated due to the tremendous amounts of friction would melt the metals, leading to the destruction of the engine. To prevent this, all moving parts ride on a thin film of oil that is pumped between all the moving parts of the engine.

Once between the moving parts, the oil serves two purposes. One purpose is to lubricate the bearing surfaces. The other purpose is to cool the bearings by absorbing the friction-generated heat. The flow of oil to the moving parts is accomplished by the engine's internal lubricating system.

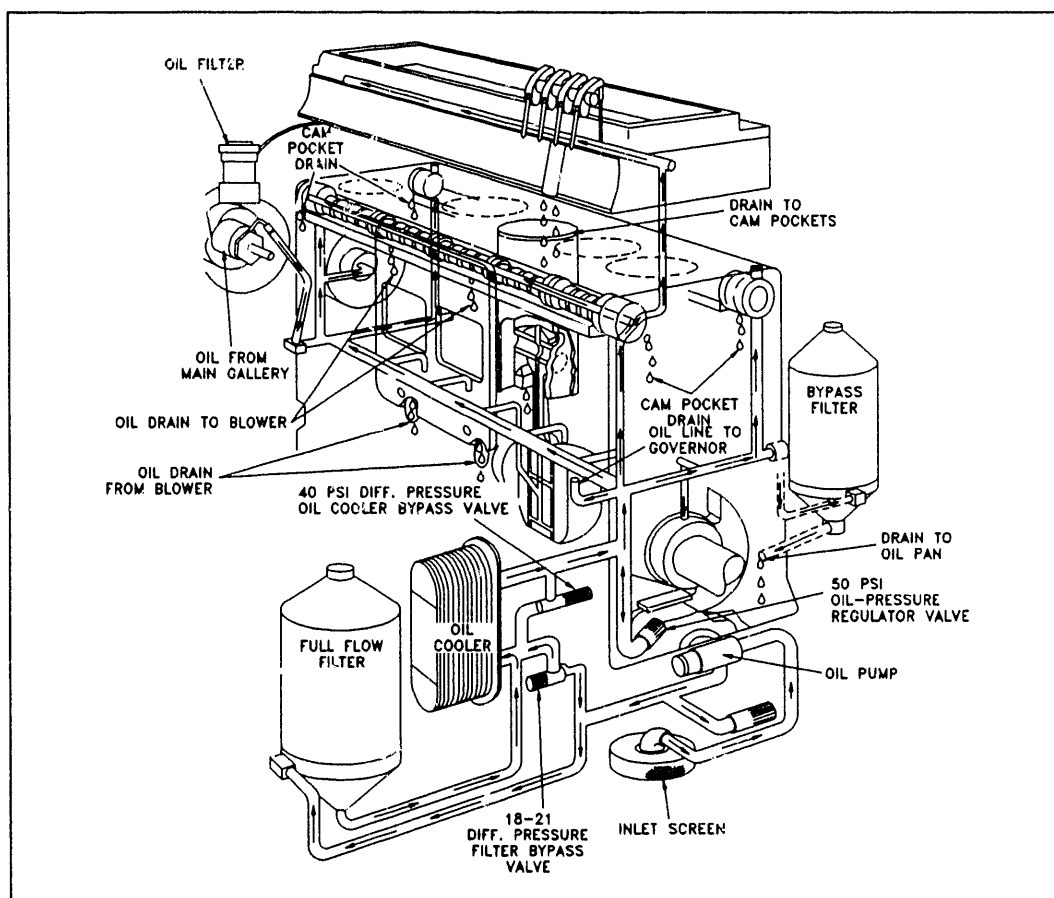

Figure 12 Diesel Engine Internal Lubrication System

Oil is accumulated and stored in the engine's oil pan where one or more oil pumps take a suction and pump the oil through one or more oil filters as shown in Figure 12. The filters clean the oil and remove any metal that the oil has picked up due to wear. The cleaned oil then flows up into the engine's oil galleries. A pressure relief valve(s) maintains oil pressure in the galleries and returns oil to the oil pan upon high pressure. The oil galleries distribute the oil to all the bearing surfaces in the engine.

Once the oil has cooled and lubricated the bearing surfaces, it flows out of the bearing and gravity-flows back into the oil pan. In medium to large diesel engines, the oil is also cooled before being distributed into the block. This is accomplished by either an internal or external oil cooler. The lubrication system also supplies oil to the engine's governor, which is discussed later in this module.

Fuel System

All diesel engines require a method to store and deliver fuel to the engine. Because diesel engines rely on injectors which are precision components with extremely tight tolerances and very small injection hole(s), the fuel delivered to the engine must be extremely clean and free of contaminants.

The fuel system must, therefore, not only deliver the fuel but also ensure its cleanliness. This is usually accomplished through a series of in-line filters. Commonly, the fuel will be filtered once outside the engine and then the fuel will pass through at least one more filter internal to the engine, usually located in the fuel line at each fuel injector.

In a diesel engine, the fuel system is much more complex than the fuel system on a simple gasoline engine because the fuel serves two purposes. One purpose is obviously to supply the fuel to run the engine; the other is to act as a coolant to the injectors. To meet this second purpose, diesel fuel is kept continuously flowing through the engine's fuel system at a flow rate much higher than required to simply run the engine, an example of a fuel flowpath is shown in Figure 13. The excess fuel is routed back to the fuel pump or the fuel storage tank depending on the application.

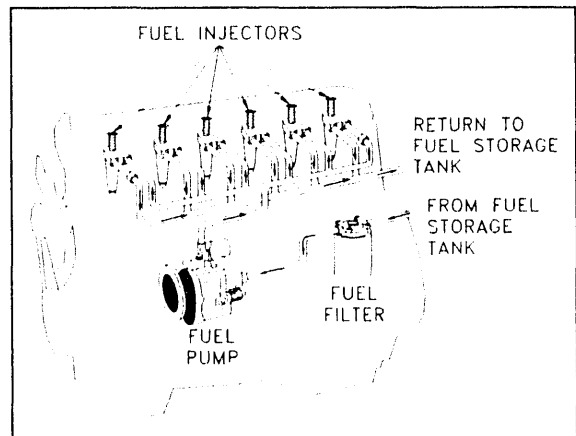

Figure 13 Diesel Engine Fuel Flowpath

Air Intake System

Because a diesel engine requires close tolerances to achieve its compression ratio, and because most diesel engines are either turbocharged or supercharged, the air entering the engine must be clean, free of debris, and as cool as possible. Turbocharging and supercharging are discussed in more detail later in this chapter. Also, to improve a turbocharged or supercharged engine's efficiency, the compressed air must be cooled after being compressed. The air intake system is designed to perform these tasks.

Air intake systems vary greatly from vendor to vendor but are usually one of two types, wet or dry. In a wet filter intake system, as shown in Figure 14, the air is sucked or bubbled through a housing that holds a bath of oil such that the dirt in the air is removed by the oil in the filter. The air then flows through a screen-type material to ensure any entrained oil is removed from the air. In a dry filter system, paper, cloth, or a metal screen material is used to catch and trap dirt before it enters the engine (similar to the type used in automobile engines).

In addition to cleaning the air, the intake system is usually designed to intake fresh air from as far away from the engine as practicable, usually just outside of the engine's building or enclosure. This provides the engine with a supply of air that has not been heated by the engine's own waste heat.

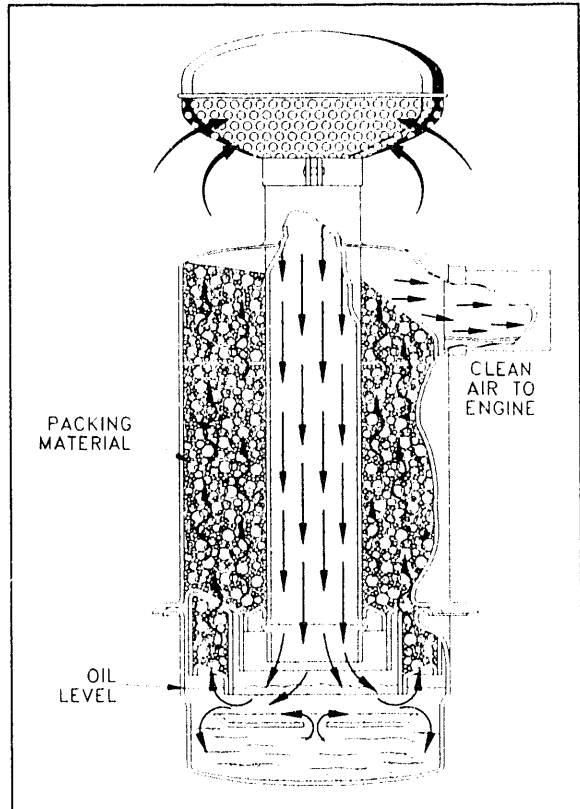

Figure 14 Oil Bath Air Filter

The reason for ensuring that an engine's air supply is as cool as possible is that cool air is more dense than hot air. This means that, per unit volume, cool air has more oxygen than hot air. Thus, cool air provides more oxygen per cylinder charge than less dense, hot air. More oxygen means a more efficient fuel burn and more power.

After being filtered, the air is routed by the intake system into the engine's intake manifold or air box. The manifold or air box is the component that directs the fresh air to each of the engine's intake valves or ports. If the engine is turbocharged or supercharged, the fresh air will be compressed with a blower and possibly cooled before entering the intake manifold or air box. The intake system also serves to reduce the air flow noise.

Turbocharging

Turbocharging an engine occurs when the engine's own exhaust gasses are forced through a turbine (impeller), which rotates and is connected to a second impeller located in the fresh air intake system. The impeller in the fresh air intake system compresses the fresh air. The compressed air serves two functions. First, it increases the engine's available power by increasing the maximum amount of air (oxygen) that is forced into each cylinder. This allows more fuel to be injected and more power to be produced by the engine. The second function is to increase intake pressure. This improves the scavenging of the exhaust gasses out of the cylinder. Turbocharging is commonly found on high power four-stroke engines. It can also be used on two-stroke engines where the increase in intake pressure generated by the turbocharger is required to force the fresh air charge into the cylinder and help force the exhaust gasses out of the cylinder to enable the engine to run.

Supercharging

Supercharging an engine performs the same function as turbocharging an engine. The difference is the source of power used to drive the device that compresses the incoming fresh air. In a supercharged engine, the air is commonly compressed in a device called a blower. The blower is driven through gears directly from the engine's crankshaft. The most common type of blower uses two rotating rotors to compress the air. Supercharging is more commonly found on two-stroke engines where the higher pressures that a supercharger is capable of generating are needed.

Exhaust System

The exhaust system of a diesel engine performs three functions. First, the exhaust system routes the spent combustion gasses away from the engine, where they are diluted by the atmosphere. This keeps the area around the engine habitable. Second, the exhaust system confines and routes the gasses to the turbocharger, if used. Third, the exhaust system allows mufflers to be used to reduce the engine noise.

Operational Terminology

Before a detailed operation of a diesel engine can be explained, several terms must be defined.

Bore and Stroke

Bore and stroke are terms used to define the size of an engine. As previously stated, *bore* refers to the diameter of the engine's cylinder, and *stroke* refers to the distance the piston travels from the top of the cylinder to the bottom. The highest point of travel by the piston is called *top dead center* (TDC), and the lowest point of travel is called *bottom dead center* (BDC). There are 180° of travel between TDC and BDC, or one stroke.

Engine Displacement

Engine displacement is one of the terms used to compare one engine to another. *Displacement* refers to the total volume displaced by all the pistons during one stroke. The displacement is usually given in cubic inches or liters. To calculate the displacement of an engine, the volume of one cylinder must be determined (volume of a cylinder = $(\pi r^2)h$ where h = the stroke). The volume of one cylinder is multiplied by the number of cylinders to obtain the total engine displacement.

Degree of Crankshaft Rotation

All events that occur in an engine are related to the location of the piston. Because the piston is connected to the crankshaft, any location of the piston corresponds directly to a specific number of degrees of crankshaft rotation.

Location of the crank can then be stated as XX degrees before or XX degrees after top or bottom dead center.

Firing Order

Firing order refers to the order in which each of the cylinders in a multicylinder engine fires (power stroke). For example, a four cylinder engine's firing order could be 1-4-3-2. This means that the number 1 cylinder fires, then the number 4 cylinder fires, then the number 3 cylinder fires, and so on. Engines are designed so that the power strokes are as uniform as possible, that is, as the crankshaft rotates a certain number of degrees, one of the cylinders will go through a power stroke. This reduces vibration and allows the power generated by the engine to be applied to the load in a smoother fashion than if they were all to fire at once or in odd multiples.

Compression Ratio and Clearance Volume

Clearance volume is the volume remaining in the cylinder when the piston is at TDC. Because of the irregular shape of the combustion chamber (volume in the head) the clearance volume is calculated empirically by filling the chamber with a measured amount of fluid while the piston is at TDC. This volume is then added to the displacement volume in the cylinder to obtain the cylinders total volume.

An engine's *compression ratio* is determined by taking the volume of the cylinder with piston at TDC (highest point of travel) and dividing the volume of the cylinder when the piston is at BDC (lowest point of travel), as shown in Figure 15. This can be calculated by using the following formula:

$$\text{Compression Ratio} = \frac{\text{displacement volume} + \text{clearance volume}}{\text{clearance volume}}$$

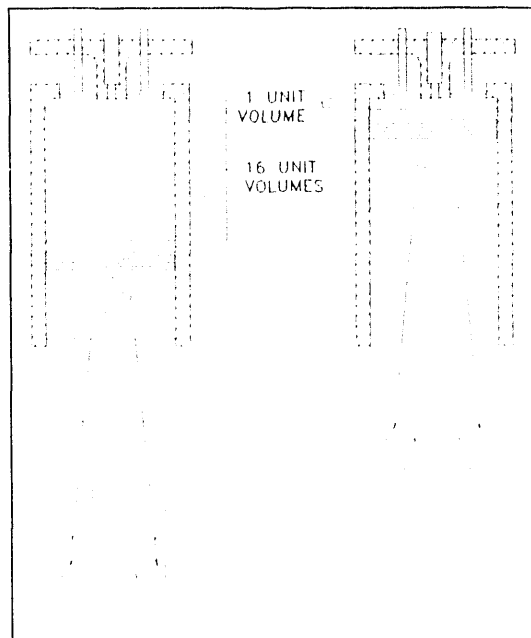

Figure 15 Compression Ratio

Horsepower

Power is the amount of work done per unit time or the rate of doing work. For a diesel engine, power is rated in units of horsepower. *Indicated horsepower* is the power transmitted to the pistons by the gas in the cylinders and is mathematically calculated.

Brake horsepower refers to the amount of usable power delivered by the engine to the crankshaft. Indicated horsepower can be as much as 15% higher than brake horsepower. The difference is due to internal engine friction, combustion inefficiencies, and parasitic losses, for example, oil pump, blower, water pump, etc.

The ratio of an engine's brake horsepower and its indicated horsepower is called the *mechanical efficiency* of the engine. The mechanical efficiency of a four-cycle diesel is about 82 to 90 percent. This is slightly lower than the efficiency of the two-cycle diesel engine. The lower mechanical efficiency is due to the additional friction losses and power needed to drive the piston through the extra 2 strokes.

Engines are rated not only in horsepower but also by the torque they produce. *Torque* is a measure of the engine's ability to apply the power it is generating. Torque is commonly given in units of lb-ft.

Summary

The important information in this chapter is summarized below.

Diesel Engines Summary

- The compression ratio is the volume of the cylinder with piston at TDC divided by the volume of the cylinder with piston at BDC.
- Bore is the diameter of the cylinder.
- Stroke is the distance the piston travels from TDC to BDC, and is determined by the eccentricity of the crankshaft.
- The combustion chamber is the volume of space where the fuel air mixture is burned in an engine. This is in the cylinder of the engine.
- The following components were discussed and identified on a drawing.
 - a. Piston and rod
 - b. Cylinder
 - c. Blower
 - d. Crankshaft
 - e. Intake ports or valve(s)
 - f. Exhaust ports or valve(s)
 - g. Fuel injector

FUNDAMENTALS OF THE DIESEL CYCLE

Diesel engines operate under the principle of the internal combustion engine. There are two basic types of diesel engines, two-cycle and four-cycle. An understanding of how each cycle operates is required to understand how to correctly operate and maintain a diesel engine.

- EO 1.3** **EXPLAIN** how a diesel engine converts the chemical energy stored in the diesel fuel into mechanical energy.
- EO 1.4** **EXPLAIN** how the ignition process occurs in a diesel engine.
- EO 1.5** **EXPLAIN** the operation of a 4-cycle diesel engine, including when the following events occur during a cycle:
- a. Intake
 - b. Exhaust
 - c. Fuel injection
 - d. Compression
 - e. Power
- EO 1.6** **EXPLAIN** the operation of a 2-cycle diesel engine, including when the following events occur during a cycle:
- a. Intake
 - b. Exhaust
 - c. Fuel injection
 - d. Compression
 - e. Power
-

The Basic Diesel Cycles

A diesel engine is a type of heat engine that uses the internal combustion process to convert the energy stored in the chemical bonds of the fuel into useful mechanical energy. This occurs in two steps. First, the fuel reacts chemically (burns) and releases energy in the form of heat. Second the heat causes the gasses trapped in the cylinder to expand, and the expanding gases, being confined by the cylinder, must move the piston to expand. The reciprocating motion of the piston is then converted into rotational motion by the crankshaft.

To convert the chemical energy of the fuel into useful mechanical energy all internal combustion engines must go through four events: intake, compression, power, and exhaust. How these events are timed and how they occur differentiates the various types of engines.

All diesel engines fall into one of two categories, two-stroke or four-stroke cycle engines. The word cycle refers to any operation or series of events that repeats itself. In the case of a four-stroke cycle engine, the engine requires four strokes of the piston (intake, compression, power, and exhaust) to complete one full cycle. Therefore, it requires two rotations of the crankshaft, or 720° of crankshaft rotation ($360^\circ \times 2$) to complete one cycle. In a two-stroke cycle engine the events (intake, compression, power, and exhaust) occur in only one rotation of the crankshaft, or 360° .

Timing

In the following discussion of the diesel cycle it is important to keep in mind the time frame in which each of the actions is required to occur. Time is required to move exhaust gas out of the cylinder and fresh air in to the cylinders, to compress the air, to inject fuel, and to burn the fuel. If a four-stroke diesel engine is running at a constant 2100 revolutions per minute (rpm), the crankshaft would be rotating at 35 revolutions, or 12,600 degrees, per second. One stroke is completed in about 0.01429 seconds.

The Four-Stroke Cycle

In a four-stroke engine the camshaft is geared so that it rotates at half the speed of the crankshaft (1:2). This means that the crankshaft must make two complete revolutions before the camshaft will complete one revolution. The following section will describe a four-stroke, normally aspirated, diesel engine having both intake and exhaust valves with a 3.5-inch bore and 4-inch stroke with a 16:1 compression ratio, as it passes through one complete cycle. We will start on the intake stroke. All the timing marks given are generic and will vary from engine to engine. Refer to Figures 10, 16, and 17 during the following discussion.

Intake

As the piston moves upward and approaches 28° before top dead center (BTDC), as measured by crankshaft rotation, the camshaft lobe starts to lift the cam follower. This causes the pushrod to move upward and pivots the rocker arm on the rocker arm shaft. As the valve lash is taken up, the rocker arm pushes the intake valve downward and the valve starts to open. The intake stroke now starts while the exhaust valve is still open. The flow of the exhaust gasses will have created a low

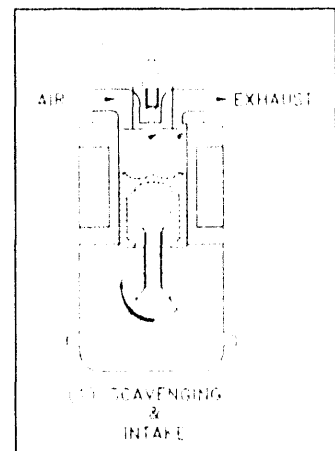

Figure 16 Scavenging and Intake

pressure condition within the cylinder and will help pull in the fresh air charge as shown in Figure 16.

The piston continues its upward travel through top dead center (TDC) while fresh air enters and exhaust gasses leave. At about 12° after top dead center (ATDC), the camshaft exhaust lobe rotates so that the exhaust valve will start to close. The valve is fully closed at 23° ATDC. This is accomplished through the valve spring, which was compressed when the valve was opened, forcing the rocker arm and cam follower back against the cam lobe as it rotates. The time frame during which both the intake and exhaust valves are open is called valve overlap (51° of overlap in this example) and is necessary to allow the fresh air to help scavenge (remove) the spent exhaust gasses and cool the cylinder. In most engines, 30 to 50 times cylinder volume is scavenged through the cylinder during overlap. This excess cool air also provides the necessary cooling effect on the engine parts.

As the piston passes TDC and begins to travel down the cylinder bore, the movement of the piston creates a suction and continues to draw fresh air into the cylinder.

Compression

At 35° after bottom dead center (ABDC), the intake valve starts to close. At 43° ABDC (or 137° BTDC), the intake valve is on its seat and is fully closed. At this point the air charge is at normal pressure (14.7 psia) and ambient air temperature ($\sim 80^\circ\text{F}$), as illustrated in Figure 17.

At about 70° BTDC, the piston has traveled about 2.125 inches, or about half of its stroke, thus reducing the volume in the cylinder by half. The temperature has now doubled to $\sim 160^\circ\text{F}$ and pressure is ~ 34 psia.

At about 43° BTDC the piston has traveled upward 3.062 inches of its stroke and the volume is once again halved. Consequently, the temperature again doubles to about 320°F and pressure is ~ 85 psia. When the piston has traveled to 3.530 inches of its stroke the volume is again halved and temperature reaches $\sim 640^\circ\text{F}$ and pressure 277 psia. When the piston has traveled to 3.757 inches of its stroke, or the volume is again halved, the temperature climbs to 1280°F and pressure reaches 742 psia. With a piston area of 9.616 in^2 the pressure in the cylinder is exerting a force of approximately 7135 lb. or 3-1/2 tons of force.

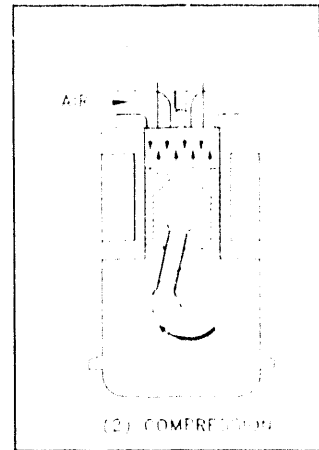

Figure 17 Compression

The above numbers are ideal and provide a good example of what is occurring in an engine during compression. In an actual engine, pressures reach only about 690 psia. This is due primarily to the heat loss to the surrounding engine parts.

Fuel Injection

Fuel in a liquid state is injected into the cylinder at a precise time and rate to ensure that the combustion pressure is forced on the piston neither too early nor too late, as shown in Figure 18. The fuel enters the cylinder where the heated compressed air is present; however, it will only burn when it is in a vaporized state (attained through the addition of heat to cause vaporization) and intimately mixed with a supply of oxygen. The first minute droplets of fuel enter the combustion chamber and are quickly vaporized. The vaporization of the fuel causes the air surrounding the fuel to cool and it requires time for the air to reheat sufficiently to ignite the vaporized fuel. But once ignition has started, the additional heat from combustion helps to further vaporize the new fuel entering the chamber, as long as oxygen is present. Fuel injection starts at 28° BTDC and ends at 3° ATDC; therefore, fuel is injected for a duration of 31°.

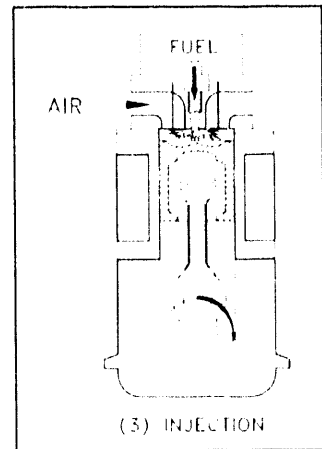

Figure 18 Fuel Injection

Power

Both valves are closed, and the fresh air charge has been compressed. The fuel has been injected and is starting to burn. After the piston passes TDC, heat is rapidly released by the ignition of the fuel, causing a rise in cylinder pressure. Combustion temperatures are around 2336°F. This rise in pressure forces the piston downward and increases the force on the crankshaft for the power stroke as illustrated in Figure 19.

The energy generated by the combustion process is not all harnessed. In a two stroke diesel engine, only about 38% of the generated power is harnessed to do work, about 30% is wasted in the form of heat rejected to the cooling system, and about 32% in the form of heat is rejected out the exhaust. In comparison, the four-stroke diesel engine has a thermal distribution of 42% converted

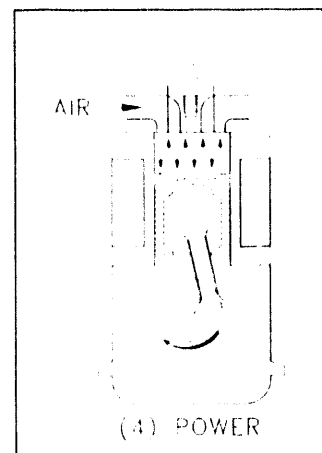

Figure 19 Power

to useful work, 28% heat rejected to the cooling system, and 30% heat rejected out the exhaust.

Exhaust

As the piston approaches 48° BBDC, the cam of the exhaust lobe starts to force the follower upward, causing the exhaust valve to lift off its seat. As shown in Figure 20, the exhaust gasses start to flow out the exhaust valve due to cylinder pressure and into the exhaust manifold. After passing BDC, the piston moves upward and accelerates to its maximum speed at 63° BTDC. From this point on the piston is decelerating. As the piston speed slows down, the velocity of the gasses flowing out of the cylinder creates a pressure slightly lower than atmospheric pressure. At 28° BTDC, the intake valve opens and the cycle starts again.

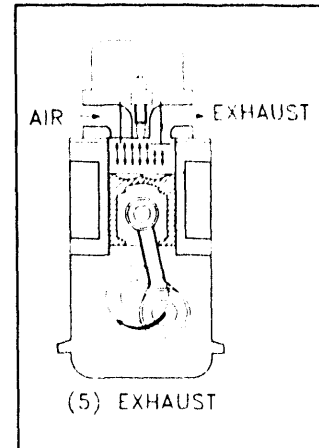

Figure 20 Exhaust

The Two-Stroke Cycle

Like the four-stroke engine, the two-stroke engine must go through the same four events: intake, compression, power, and exhaust. But a two-stroke engine requires only two strokes of the piston to complete one full cycle. Therefore, it requires only one rotation of the crankshaft to complete a cycle. This means several events must occur during each stroke for all four events to be completed in two strokes, as opposed to the four-stroke engine where each stroke basically contains one event.

In a two-stroke engine the camshaft is geared so that it rotates at the same speed as the crankshaft (1:1). The following section will describe a two-stroke, supercharged, diesel engine having intake ports and exhaust valves with a 3.5-inch bore and 4-inch stroke with a 16:1 compression ratio, as it passes through one complete cycle. We will start on the exhaust stroke. All the timing marks given are generic and will vary from engine to engine.

Exhaust and Intake

At 82° ATDC, with the piston near the end of its power stroke, the exhaust cam begins to lift the exhaust valves follower. The valve lash is taken up, and 9° later (91° ATDC), the rocker arm forces the exhaust valve off its seat. The exhaust gasses start to escape into the exhaust manifold, as shown in Figure 21. Cylinder pressure starts to decrease.

After the piston travels three-quarters of its (down) stroke, or 132° ATDC of crankshaft rotation, the piston starts to uncover the inlet ports. As the exhaust valve is still open, the uncovering of the inlet ports lets the compressed fresh air enter the cylinder and helps cool the cylinder and scavenge the cylinder of the remaining exhaust gasses (Figure 22). Commonly, intake and exhaust occur over approximately 96° of crankshaft rotation.

At 43° ABDC, the camshaft starts to close the exhaust valve. At 53° ABDC (117° BTDC), the camshaft has rotated sufficiently to allow the spring pressure to close the exhaust valve. Also, as the piston travels past 48° ABDC (5° after the exhaust valve starts closing), the intake ports are closed off by the piston.

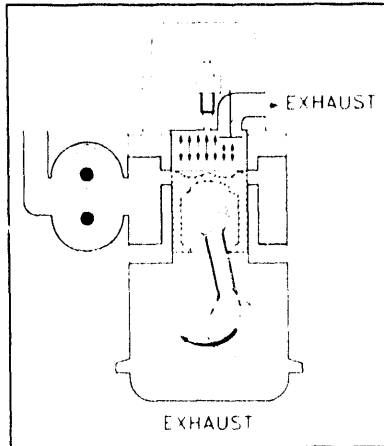

Figure 21 2-Stroke Exhaust

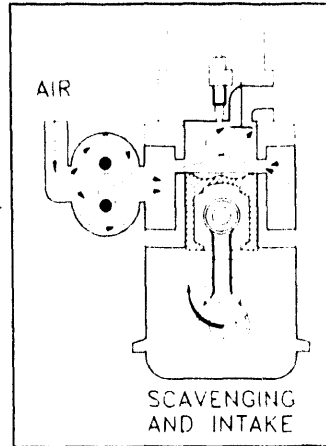

Figure 22 2-Stroke Intake

Compression

After the exhaust valve is on its seat (53° ATDC), the temperature and pressure begin to rise in nearly the same fashion as in the four-stroke engine. Figure 23 illustrates the compression in a 2-stroke engine. At 23° BTDC the injector cam begins to lift the injector follower and pushrod. Fuel injection continues until 6° BTDC (17 total degrees of injection), as illustrated in Figure 24.

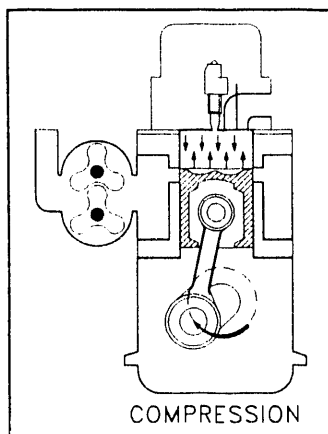

Figure 23 2-Stroke Compression

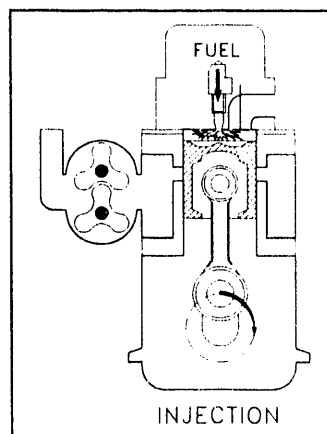

Figure 24 2-Stroke Fuel Injection

Power

The power stroke starts after the piston passes TDC. Figure 25 illustrates the power stroke which continues until the piston reaches 91° ATDC, at which point the exhaust valves start to open and a new cycle begins.

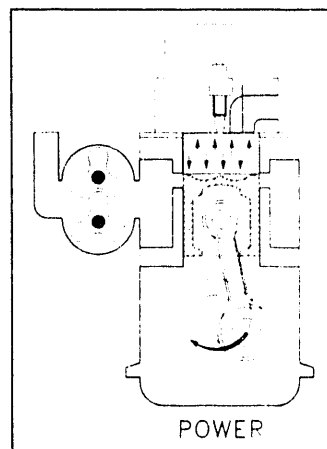

Figure 25 2-Stroke Power

Summary

The important information in this chapter is summarized below.

Fundamentals of the Diesel Cycle Summary

- Ignition occurs in a diesel by injecting fuel into the air charge which has been heated by compression to a temperature greater than the ignition point of the fuel.
- A diesel engine converts the energy stored in the fuel's chemical bonds into mechanical energy by burning the fuel. The chemical reaction of burning the fuel liberates heat, which causes the gasses to expand, forcing the piston to rotate the crankshaft.
- A four-stroke engine requires two rotations of the crankshaft to complete one cycle. The event occur as follows:

Intake - the piston passes TDC, the intake valve(s) open and the fresh air is admitted into the cylinder, the exhaust valve is still open for a few degrees to allow scavenging to occur.

Compression - after the piston passes BDC the intake valve closes and the piston travels up to TDC (completion of the first crankshaft rotation).

Fuel injection - As the piston nears TDC on the compression stroke, the fuel is injected by the injectors and the fuel starts to burn, further heating the gasses in the cylinder.

Power - the piston passes TDC and the expanding gasses force the piston down, rotating the crankshaft.

Exhaust - as the piston passes BDC the exhaust valves open and the exhaust gasses start to flow out of the cylinder. This continues as the piston travels up to TDC, pumping the spent gasses out of the cylinder. At TDC the second crankshaft rotation is complete.

Fundamentals of the Diesel Cycle Summary (Cont.)

- A two-stroke engine requires one rotation of the crankshaft to complete one cycle. The events occur as follows:

Intake - the piston is near BDC and exhaust is in progress. The intake valve or ports open and the fresh air is forced in. The exhaust valves or ports are closed and intake continues.

Compression - after both the exhaust and intake valves or ports are closed, the piston travels up towards TDC. The fresh air is heated by the compression.

Fuel injection - near TDC the fuel is injected by the injectors and the fuel starts to burn, further heating the gasses in the cylinder.

Power - the piston passes TDC and the expanding gasses force the piston down, rotating the crankshaft.

Exhaust - as the piston approaches BDC the exhaust valves or ports open and the exhaust gasses start to flow out of the cylinder.

DIESEL ENGINE SPEED, FUEL CONTROLS, AND PROTECTION

Understanding how diesel engines are controlled and the types of protective instrumentation available is important for a complete understanding of the operation of a diesel engine.

- EO 1.7** **DESCRIBE** how the mechanical-hydraulic governor on a diesel engine controls engine speed.
- EO 1.8** **LIST** five protective alarms usually found on mid-sized and larger diesel engines.
-

Engine Control

The control of a diesel engine is accomplished through several components: the camshaft, the fuel injector, and the governor. The camshaft provides the timing needed to properly inject the fuel, the fuel injector provides the component that meters and injects the fuel, and the governor regulates the amount of fuel that the injector is to inject. Together, these three major components ensure that the engine runs at the desired speed.

Fuel Injectors

Each cylinder has a fuel injector designed to meter and inject fuel into the cylinder at the proper instant. To accomplish this function, the injectors are actuated by the engine's camshaft. The camshaft provides the timing and pumping action used by the injector to inject the fuel. The injectors meter the amount of fuel injected into the cylinder on each stroke. The amount of fuel to be injected by each injector is set by a mechanical linkage called the fuel rack. The fuel rack position is controlled by the engine's governor. The governor determines the amount of fuel required to maintain the desired engine speed and adjusts the amount to be injected by adjusting the position of the fuel rack.

Each injector operates in the following manner. As illustrated in Figure 26, fuel under pressure enters the injector through the injector's filter cap and filter element. From the filter element the fuel travels down into the supply chamber (that area between the plunger bushing and the spill deflector). The plunger operates up and down in the bushing, the bore of which is open to the fuel supply in the supply chamber by two funnel-shaped ports in the plunger bushing.

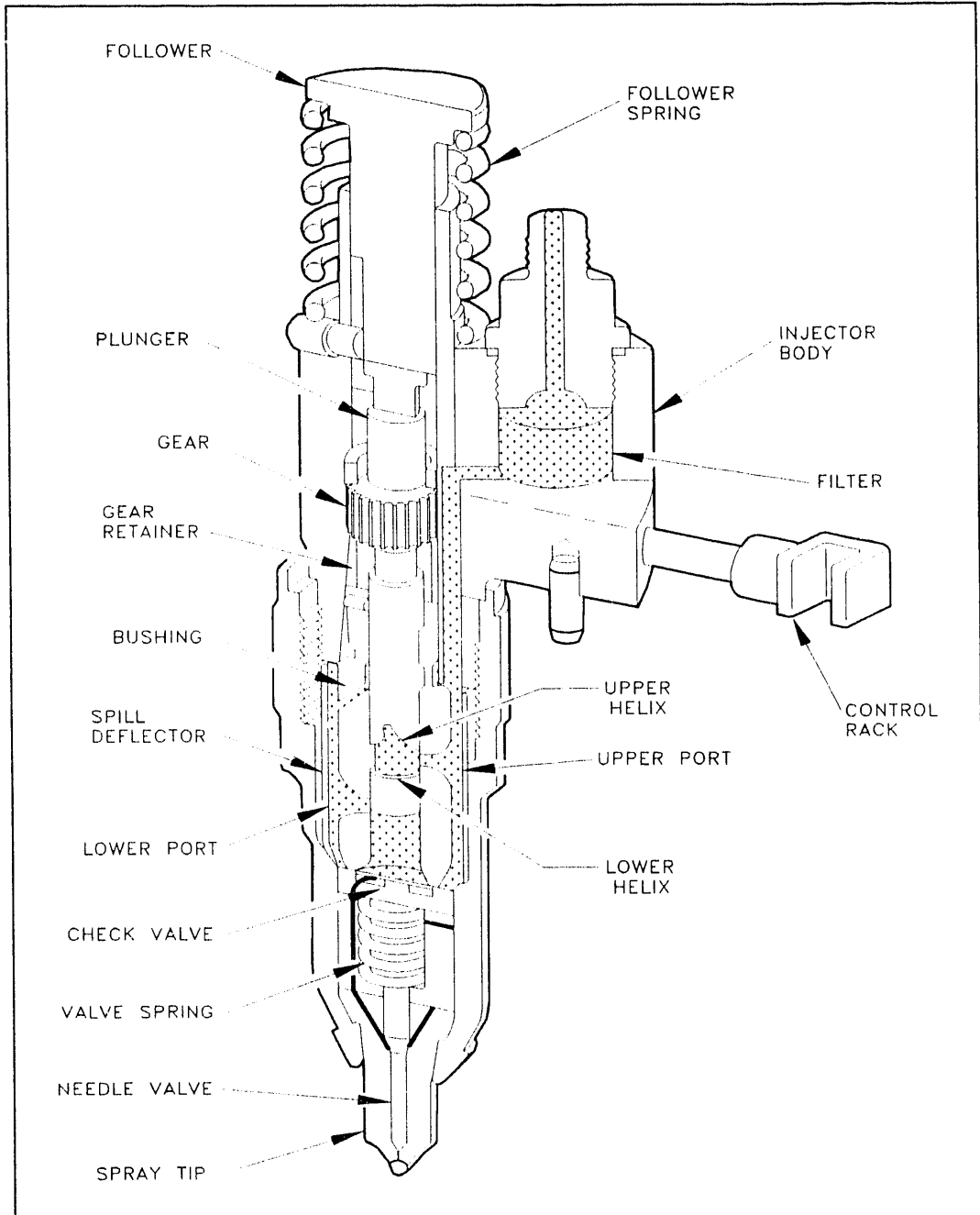

Figure 26 Fuel Injector Cutaway

The motion of the injector rocker arm (not shown) is transmitted to the plunger by the injector follower which bears against the follower spring. As the plunger moves downward under pressure of the injector rocker arm, a portion of the fuel trapped under the plunger is displaced into the supply chamber through the lower port until the port is closed off by the lower end of the plunger. The fuel trapped below the plunger is then forced up through the central bore of the plunger and back out the upper port until the upper port is closed off by the downward motion of the plunger. With the upper and lower ports both closed off, the remaining fuel under the plunger is subjected to an increase in pressure by the downward motion of the plunger.

When sufficient pressure has built up, the injector valve is lifted off its seat and the fuel is forced through small orifices in the spray tip and atomized into the combustion chamber. A check valve, mounted in the spray tip, prevents air in the combustion chamber from flowing back into the fuel injector. The plunger is then returned back to its original position by the injector follower spring.

On the return upward movement of the plunger, the high pressure cylinder within the bushing is again filled with fresh fuel oil through the ports. The constant circulation of fresh, cool fuel through the injector renews the fuel supply in the chamber and helps cool the injector. The fuel flow also effectively removes all traces of air that might otherwise accumulate in the system.

The fuel injector outlet opening, through which the excess fuel returns to the fuel return manifold and then back to the fuel tank, is adjacent to the inlet opening and contains a filter element exactly the same as the one on the fuel inlet side.

In addition to the reciprocating motion of the plunger, the plunger can be rotated during operation around its axis by the gear which meshes with the fuel rack. For metering the fuel, an upper helix and a lower helix are machined in the lower part of the plunger. The relation of the helices to the two ports in the injector bushing changes with the rotation of the plunger.

Changing the position of the helices, by rotating the plunger, retards or advances the closing of the ports and the beginning and ending of the injection period. At the same time, it increases or decreases the amount of fuel injected into the cylinder. Figure 27 illustrates the various plunger positions from NO LOAD to FULL LOAD. With the control rack pulled all the way (no injection), the upper port is not closed by the helix until after the lower port is uncovered. Consequently, with the rack in this position, all of the fuel is forced back into the supply chamber and no injection of fuel takes place. With the control rack pushed all the way in (full injection), the upper port is closed shortly after the lower port has been covered, thus producing a maximum effective stroke and maximum fuel injection. From this no-injection position to the full-injection position (full rack movement), the contour of the upper helix advances the closing of the ports and the beginning of injection.

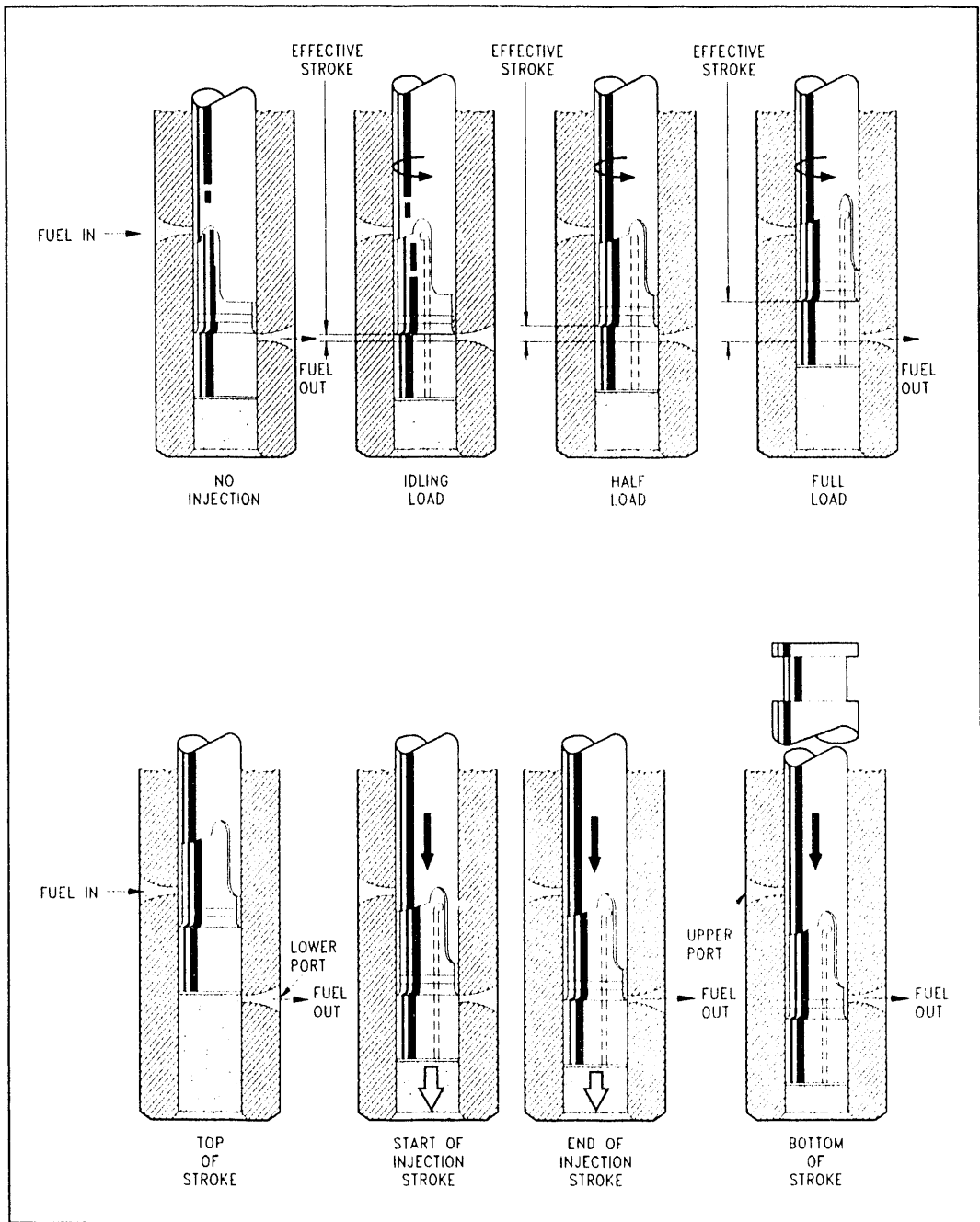

Figure 27 Fuel Injector Plunger

Governor

Diesel engine speed is controlled solely by the amount of fuel injected into the engine by the injectors. Because a diesel engine is not self-speed-limiting, it requires not only a means of changing engine speed (throttle control) but also a means of maintaining the desired speed. The governor provides the engine with the feedback mechanism to change speed as needed and to maintain a speed once reached.

A governor is essentially a speed-sensitive device, designed to maintain a constant engine speed regardless of load variation. Since all governors used on diesel engines control engine speed through the regulation of the quantity of fuel delivered to the cylinders, these governors may be classified as speed-regulating governors. As with the engines themselves there are many types and variations of governors. In this module, only the common mechanical-hydraulic type governor will be reviewed.

The major function of the governor is determined by the application of the engine. In an engine that is required to come up and run at only a single speed regardless of load, the governor is called a constant-speed type governor. If the engine is manually controlled, or controlled by an outside device with engine speed being controlled over a range, the governor is called a variable-speed type governor. If the engine governor is designed to keep the engine speed above a minimum and below a maximum, then the governor is a speed-limiting type. The last category of governor is the load limiting type. This type of governor limits fuel to ensure that the engine is not loaded above a specified limit. Note that many governors act to perform several of these functions simultaneously.

Operation of a Governor

The following is an explanation of the operation of a constant speed, hydraulically compensated governor using the Woodward brand governor as an example. The principles involved are common in any mechanical and hydraulic governor.

The Woodward speed governor operates the diesel engine fuel racks to ensure a constant engine speed is maintained at any load. The governor is a mechanical-hydraulic type governor and receives its supply of oil from the engine lubricating system. This means that a loss of lube oil pressure will cut off the supply of oil to the governor and cause the governor to shut down the engine. This provides the engine with a built-in shutdown device to protect the engine in the event of loss of lubricating oil pressure.

Simplified Operation of the Governor

The governor controls the fuel rack position through a combined action of the hydraulic piston and a set of mechanical flyweights, which are driven by the engine blower shaft. Figure 28 provides an illustration of a functional diagram of a mechanical-hydraulic governor. The position of the flyweights is determined by the speed of the engine. As the engine speeds up or down, the weights move in or out. The movement of the flyweights, due to a change in engine speed, moves a small piston (pilot valve) in the governor's hydraulic system. This motion adjusts flow of hydraulic fluid to a large hydraulic piston (servo-motor piston). The large hydraulic piston is linked to the fuel rack and its motion resets the fuel rack for increased/decreased fuel.

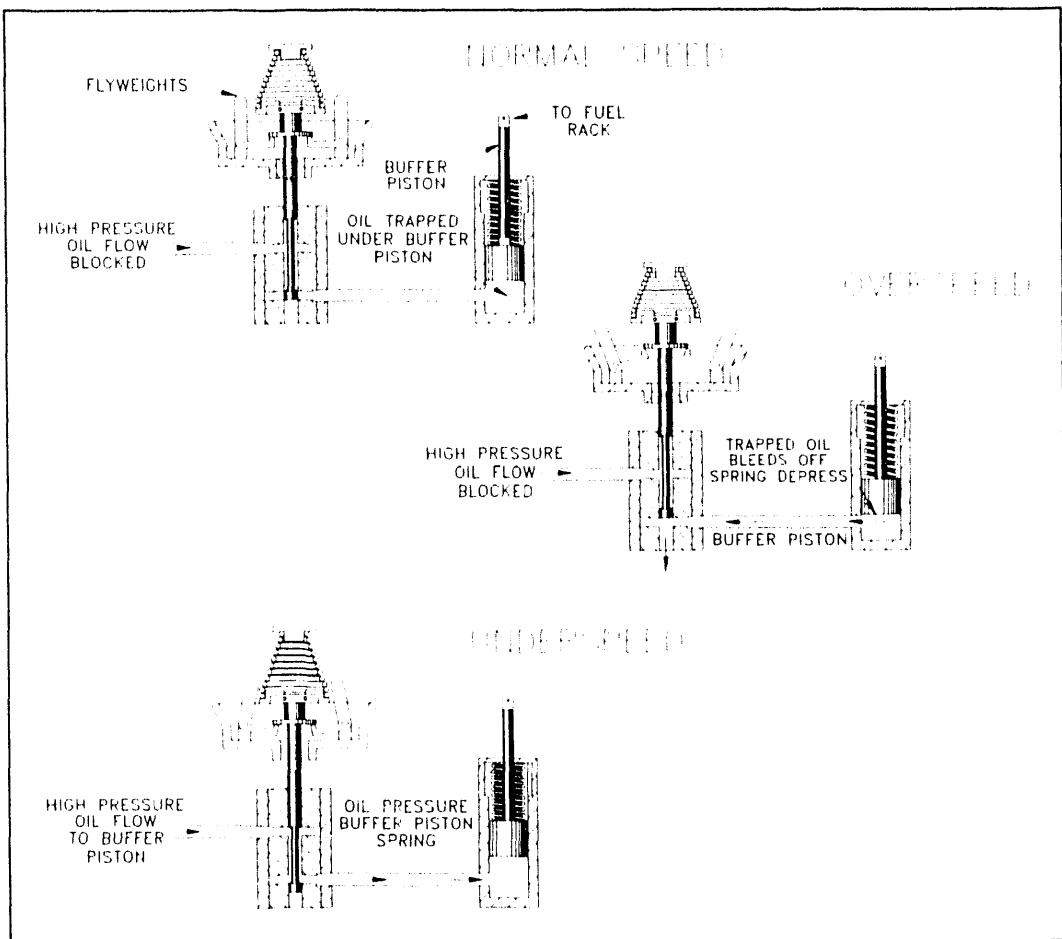

Figure 28 Simplified Mechanical-Hydraulic Governor

Detailed Operation of the Governor

With the engine operating, oil from the engine lubrication system is supplied to the governor pump gears, as illustrated in Figure 29. The pump gears raise the oil pressure to a value determined by the spring relief valve. The oil pressure is maintained in the annular space between the undercut portion of the pilot valve plunger and the bore in the pilot valve bushing. For any given speed setting, the spring speeder exerts a force that is opposed by the centrifugal force of the revolving flyweights. When the two forces are equal, the control land on the pilot valve plunger covers the lower ports in the pilot valve bushing.

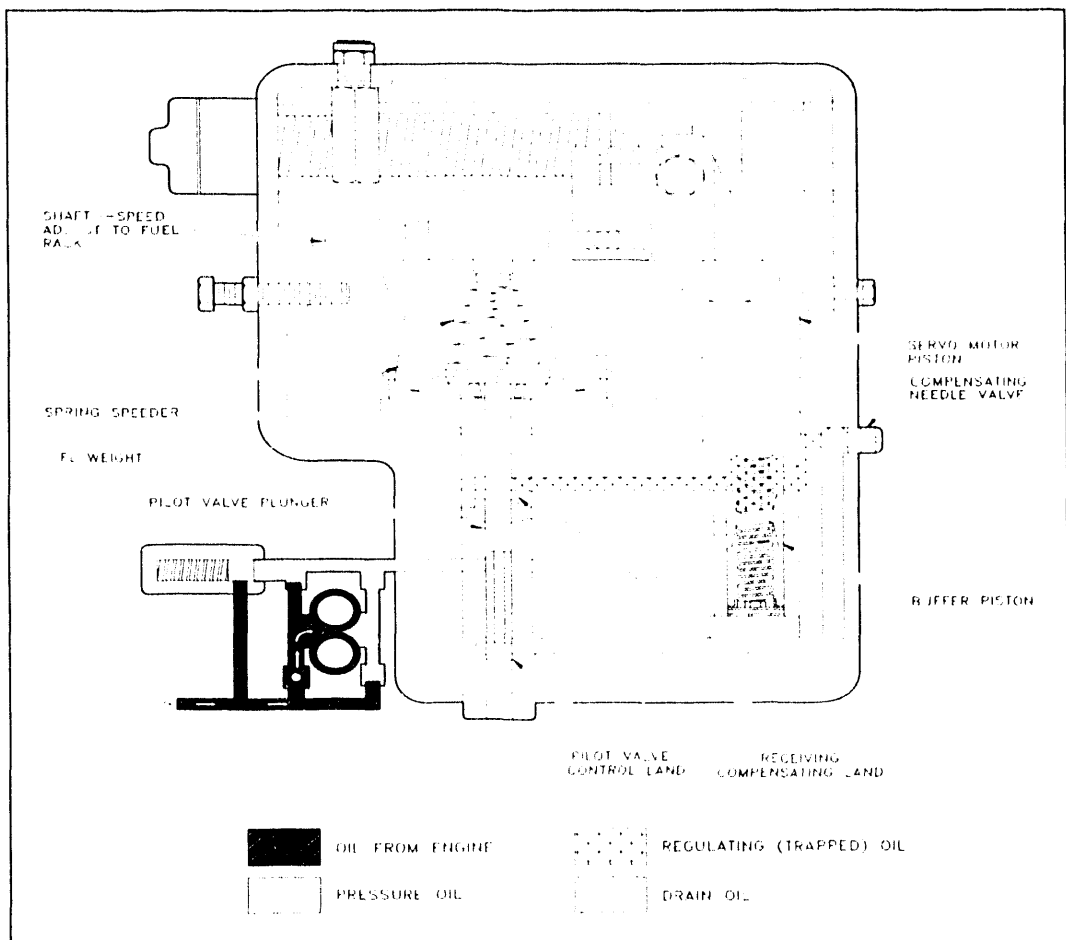

Figure 29 Cutaway of a Woodward Governor

Under these conditions, equal oil pressures are maintained on both sides of the buffer piston and tension on the two buffer springs is equal. Also, the oil pressure is equal on both sides of the receiving compensating land of the pilot valve plunger due to oil passing through the compensating needle valve. Thus, the hydraulic system is in balance, and the engine speed remains constant.

When the engine load increases, the engine starts to slow down in speed. The reduction in engine speed will be sensed by the governor flyweights. The flyweights are forced inward (by the spring), thus lowering the pilot valve plunger (again, due to the downward spring force). Oil under pressure will be admitted under the servo-motor piston (topside of the buffer piston) causing it to rise. This upward motion of the servo-motor piston will be transmitted through the terminal lever to the fuel racks, thus increasing the amount of fuel injected into the engine. The oil that forces the servo-motor piston upward also forces the buffer piston upward because the oil pressure on each side of the piston is unequal. This upward motion of the piston compresses the upper buffer spring and relieves the pressure on the lower buffer spring.

The oil cavities above and below the buffer piston are common to the receiving compensating land on the pilot valve plunger. Because the higher pressure is below the compensating land, the pilot valve plunger is forced upward, recentering the flyweights and causing the control land of the pilot valve to close off the regulating port. Thus, the upward movement of the servo-motor piston stops when it has moved far enough to make the necessary fuel correction.

Oil passing through the compensating needle valve slowly equalizes the pressures above and below the buffer piston, thus allowing the buffer piston to return to the center position, which in turn equalizes the pressure above and below the receiving compensating land. The pilot valve plunger then moves to its central position and the engine speed returns to its original setting because there is no longer any excessive outward force on the flyweights.

The action of the flyweights and the hydraulic feedback mechanism produces stable engine operation by permitting the governor to move instantaneously in response to the load change and to make the necessary fuel adjustment to maintain the initial engine speed.

Starting Circuits

Diesel engines have as many different types of starting circuits as there are types, sizes, and manufacturers of diesel engines. Commonly, they can be started by air motors, electric motors, hydraulic motors, and manually. The start circuit can be a simple manual start pushbutton, or a complex auto-start circuit. But in almost all cases the following events must occur for the starting engine to start.

1. The start signal is sent to the starting motor. The air, electric, or hydraulic motor, will engage the engine's flywheel.
2. The starting motor will crank the engine. The starting motor will spin the engine at a high enough rpm to allow the engine's compression to ignite the fuel and start the engine running.
3. The engine will then accelerate to idle speed. When the starter motor is overdriven by the running motor it will disengage the flywheel.

Because a diesel engine relies on compression heat to ignite the fuel, a cold engine can rob enough heat from the gasses that the compressed air falls below the ignition temperature of the fuel. To help overcome this condition, some engines (usually small to medium sized engines) have glowplugs. Glowplugs are located in the cylinder head of the combustion chamber and use electricity to heat up the electrode at the top of the glowplug. The heat added by the glowplug is sufficient to help ignite the fuel in the cold engine. Once the engine is running, the glowplugs are turned off and the heat of combustion is sufficient to heat the block and keep the engine running.

Larger engines usually heat the block and/or have powerful starting motors that are able to spin the engine long enough to allow the compression heat to fire the engine. Some large engines use air start manifolds that inject compressed air into the cylinders which rotates the engine during the start sequence.

Engine Protection

A diesel engine is designed with protection systems to alert the operators of abnormal conditions and to prevent the engine from destroying itself.

Overspeed device - Because a diesel is not self-speed-limiting, a failure in the governor, injection system, or sudden loss of load could cause the diesel to overspeed. An overspeed condition is extremely dangerous because engine failure is usually catastrophic and can possibly cause the engine to fly apart.

An overspeed device, usually some type of mechanical flyweight, will act to cut off fuel to the engine and alarm at a certain preset rpm. This is usually accomplished by isolating the governor from its oil supply, causing it to travel to the no-fuel position, or it can override the governor and directly trip the fuel rack to the no-fuel position.

Water jacket - Water-cooled engines can overheat if the cooling water system fails to remove waste heat. Removal of the waste heat prevents the engine from seizing due to excessive expansion of the components under a high temperature condition. The cooling water jacket is commonly where the sensor for the cooling water system is located.

The water jacket temperature sensors provide early warning of abnormal engine temperature, usually an alarm function only. The setpoint is set such that if the condition is corrected in a timely manner, significant engine damage will be avoided. But continued engine operation at the alarm temperature or higher temperatures will lead to engine damage.

Exhaust temperatures - In a diesel engine, exhaust temperatures are very important and can provide a vast amount of information regarding the operation of the engine. High exhaust temperature can indicate an overloading of the engine or possible poor performance due to inadequate scavenging (the cooling effect) in the engine. Extended operation with high exhaust temperatures can result in damage to the exhaust valves, piston, and cylinders. The exhaust temperature usually provides only an alarm function.

Low lube oil pressure - Low oil pressure or loss of oil pressure can destroy an engine in short order. Therefore, most medium to larger engines will stop upon low or loss of oil pressure. Loss of oil pressure can result in the engine seizing due to lack of lubrication. Engines with mechanical-hydraulic governors will also stop due to the lack of oil to the governor.

The oil pressure sensor usually stops the engine. The oil pressure sensors on larger engines usually have two low pressure setpoints. One setpoint provides early warning of abnormal oil pressure, an alarm function only. The second setpoint can be set to shutdown the engine before permanent damage is done.

High crankcase
pressure -

High crankcase pressure is usually caused by excessive blow-by (gas pressure in the cylinder blowing by the piston rings and into the crankcase). The high pressure condition indicates the engine is in poor condition. The high crankcase pressure is usually used only as an alarm function.

Summary

The important information in this chapter is summarized below.

Diesel Engine Speed, Fuel Controls, and Protection Summary

- A mechanical-hydraulic governor controls engine speed by balancing engine speed (mechanical flyweights) against hydraulic pressure. As the engine speeds up or slows down, the weights move the hydraulic plunger in or out. This in turn actuates a hydraulic valve which controls the hydraulic pressure to the buffer piston. The buffer piston is connected to the fuel rack. Therefore, any motion of the buffer piston will control fuel to the cylinder by adjusting the position of the fuel rack, which regulates the amount of fuel in the injectors.
- Most mid-sized to large diesel engines have (as a minimum) the following protective alarms and trips.

Engine overspeed alarm/trip
High water jacket temperature alarm
High exhaust temperature alarm
Low lube oil pressure (alarm and/or trip)
High crankcase pressure alarm

**Department of Energy
Fundamentals Handbook**

**MECHANICAL SCIENCE
Module 2
Heat Exchangers**

TABLE OF CONTENTS

LIST OF FIGURES	ii
LIST OF TABLES	iii
REFERENCES	iv
OBJECTIVES	v
TYPES OF HEAT EXCHANGERS	1
Introduction	1
Types of Heat Exchanger Construction	2
Types of Heat Exchangers	4
Comparison of the Types of Heat Exchangers	6
Summary	11
HEAT EXCHANGER APPLICATIONS	12
Introduction	12
Preheater	12
Radiator	13
Air Conditioner Evaporator and Condenser	14
Large Steam System Condensers	14
Summary	18

LIST OF FIGURES

Figure 1 Tube and Shell Heat Exchanger	3
Figure 2 Plate Heat Exchanger	4
Figure 3 Parallel Flow Heat Exchanger	5
Figure 4 Counter Flow Heat Exchange	5
Figure 5 Cross Flow Heat Exchanger	6
Figure 6 Single and Multi-Pass Heat Exchangers	9
Figure 7 Regenerative and Non-Regenerative Heat Exchangers	10
Figure 8 U-tube Feedwater Heat Exchanger	13
Figure 9 Single Pass Condenser	15
Figure 10 Jet Pump	16

LIST OF TABLES

- NONE

REFERENCES

- Babcock & Wilcox, Steam, Its Generations and Use, Babcock & Wilcox Co.
- Cheremisinoff, N. P., Fluid Flow, Pumps, Pipes and Channels, Ann Arbor Science.
- Heat Transfer, Thermodynamics and Fluid Flow Fundamentals, Columbia, MD, General Physics Corporation, Library of Congress Card #A 326517.
- Marley, Cooling Tower Fundamentals and Applications, The Marley Company.

TERMINAL OBJECTIVE

- 1.0 Without references, **DESCRIBE** the purpose, construction, and principles of operation for each major type of heat exchanger: parallel flow, counter flow, and cross flow.

ENABLING OBJECTIVES

- 1.1 **STATE** the two types of heat exchanger construction.
- 1.2 Provided with a drawing of a heat exchanger, **IDENTIFY** the following internal parts:
- a. Tubes
 - b. Tube sheet
 - c. Shell
 - d. Baffles
- 1.3 **DESCRIBE** hot and cold fluid flow in parallel flow, counter flow, and cross flow heat exchangers.
- 1.4 **DIFFERENTIATE** between the following types of heat exchangers:
- a. Single-pass versus multi-pass heat exchangers.
 - b. Regenerative versus non-regenerative heat exchangers.
- 1.5 **LIST** at least three applications of heat exchangers.
- 1.6 **STATE** the purpose of a condenser.
- 1.7 **DEFINE** the following terms:
- a. Hotwell
 - b. Condensate depression
- 1.8 **STATE** why condensers in large steam cycles are operated at a vacuum.

Intentionally Left Blank

TYPES OF HEAT EXCHANGERS

In almost any nuclear, chemical, or mechanical system, heat must be transferred from one place to another or from one fluid to another. Heat exchangers are used to transfer heat from one fluid to another. A basic understanding of the mechanical components of a heat exchanger is important to understanding how they function and operate.

- EO 1.1 STATE the two types of heat exchanger construction.**
- EO 1.2 Provided with a drawing of a heat exchanger, IDENTIFY the following internal parts:**
- a. Tubes
 - b. Tube sheet
 - c. Shell
 - d. Baffles
- EO 1.3 DESCRIBE hot and cold fluid flow in parallel flow, counter flow, and cross flow heat exchangers.**
- EO 1.4 DIFFERENTIATE between the following types of heat exchangers:**
- a. Single-pass versus multi-pass heat exchangers
 - b. Regenerative versus non-regenerative heat exchangers
-

Introduction

A heat exchanger is a component that allows the transfer of heat from one fluid (liquid or gas) to another fluid. Reasons for heat transfer include the following:

1. To heat a cooler fluid by means of a hotter fluid
2. To reduce the temperature of a hot fluid by means of a cooler fluid
3. To boil a liquid by means of a hotter fluid
4. To condense a gaseous fluid by means of a cooler fluid
5. To boil a liquid while condensing a hotter gaseous fluid

Regardless of the function the heat exchanger fulfills, in order to transfer heat the fluids involved must be at different temperatures and they must come into thermal contact. Heat can flow only from the hotter to the cooler fluid.

In a heat exchanger there is no direct contact between the two fluids. The heat is transferred from the hot fluid to the metal isolating the two fluids and then to the cooler fluid.

Types of Heat Exchanger Construction

Although heat exchangers come in every shape and size imaginable, the construction of most heat exchangers fall into one of two categories: tube and shell, or plate. As in all mechanical devices, each type has its advantages and disadvantages.

Tube and Shell

The most basic and the most common type of heat exchanger construction is the tube and shell, as shown in Figure 1. This type of heat exchanger consists of a set of *tubes* in a container called a *shell*. The fluid flowing inside the tubes is called the tube side fluid and the fluid flowing on the outside of the tubes is the shell side fluid. At the ends of the tubes, the tube side fluid is separated from the shell side fluid by the tube sheet(s). The tubes are rolled and press-fitted or welded into the tube sheet to provide a leak tight seal. In systems where the two fluids are at vastly different pressures, the higher pressure fluid is typically directed through the tubes and the lower pressure fluid is circulated on the shell side. This is due to economy, because the heat exchanger tubes can be made to withstand higher pressures than the shell of the heat exchanger for a much lower cost. The support plates shown on Figure 1 also act as baffles to direct the flow of fluid within the shell back and forth across the tubes.

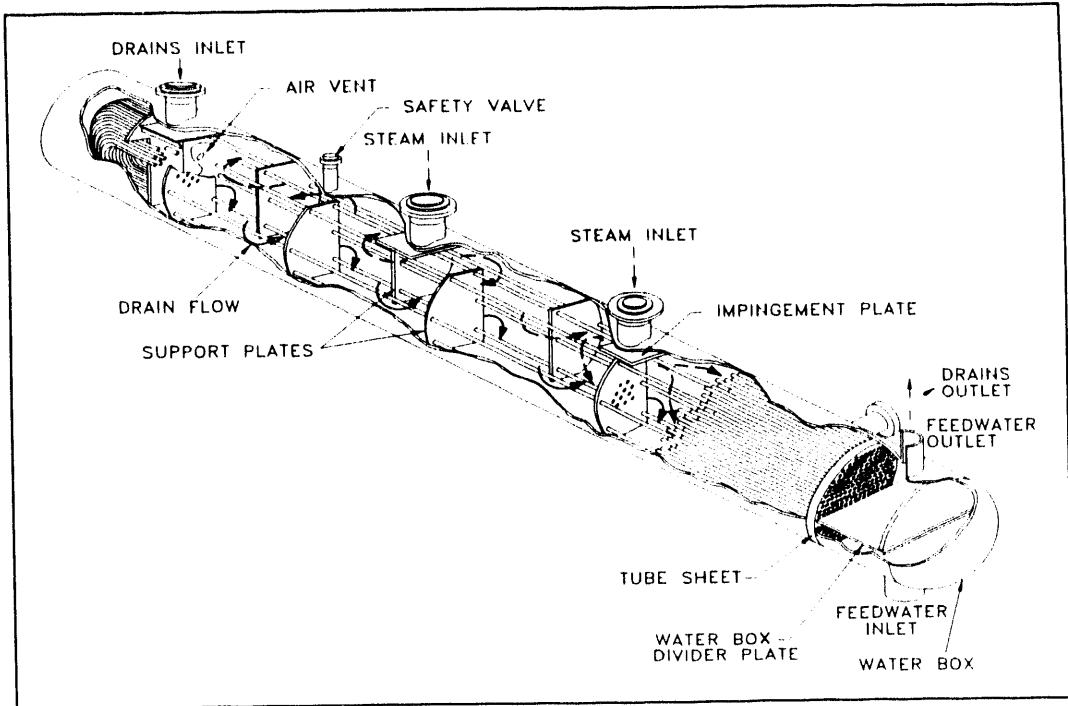

Figure 1 Tube and Shell Heat Exchanger

Plate

A plate type heat exchanger, as illustrated in Figure 2, consists of plates instead of tubes to separate the hot and cold fluids. The hot and cold fluids alternate between each of the plates. Baffles direct the flow of fluid between plates. Because each of the plates has a very large surface area, the plates provide each of the fluids with an extremely large heat transfer area. Therefore a plate type heat exchanger, as compared to a similarly sized tube and shell heat exchanger, is capable of transferring much more heat. This is due to the larger area the plates provide over tubes. Due to the high heat transfer efficiency of the plates, plate type heat exchangers are usually very small when compared to a tube and shell type heat exchanger with the same heat transfer capacity. Plate type heat exchangers are not widely used because of the inability to reliably seal the large gaskets between each of the plates. Because of this problem, plate type heat exchangers have only been used in small, low pressure applications such as on oil coolers for engines. However, new improvements in gasket design and overall heat exchanger design have allowed some large scale applications of the plate type heat exchanger. As older facilities are upgraded or newly designed facilities are built, large plate type heat exchangers are replacing tube and shell heat exchangers and becoming more common.

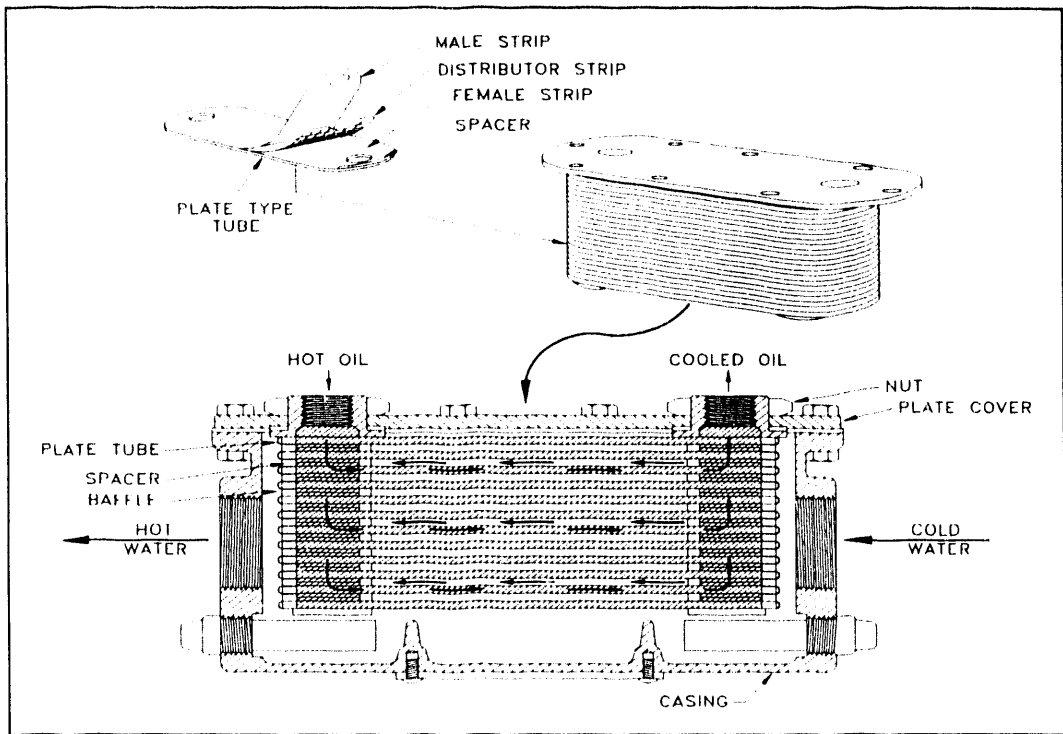

Figure 2 Plate Heat Exchanger

Types of Heat Exchangers

Because heat exchangers come in so many shapes, sizes, makes, and models, they are categorized according to common characteristics. One common characteristic that can be used to categorize them is the direction of flow the two fluids have relative to each other. The three categories are parallel flow, counter flow and cross flow.

Parallel flow, as illustrated in Figure 3, exists when both the tube side fluid and the shell side fluid flow in the same direction. In this case, the two fluids enter the heat exchanger from the same end with a large temperature difference. As the fluids transfer heat, hotter to cooler, the temperatures of the two fluids approach each other. Note that the hottest cold-fluid temperature is always less than the coldest hot-fluid temperature.

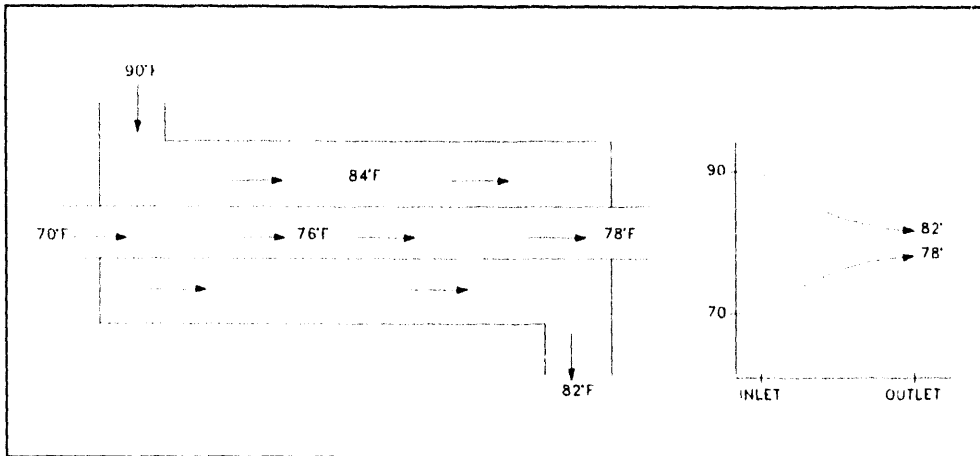

Figure 3 Parallel Flow Heat Exchanger

Counter flow, as illustrated in Figure 4, exists when the two fluids flow in opposite directions. Each of the fluids enters the heat exchanger at opposite ends. Because the cooler fluid exits the counter flow heat exchanger at the end where the hot fluid enters the heat exchanger, the cooler fluid will approach the inlet temperature of the hot fluid. Counter flow heat exchangers are the most efficient of the three types. In contrast to the parallel flow heat exchanger, the counter flow heat exchanger can have the hottest cold-fluid temperature greater than the coldest hot-fluid temperature.

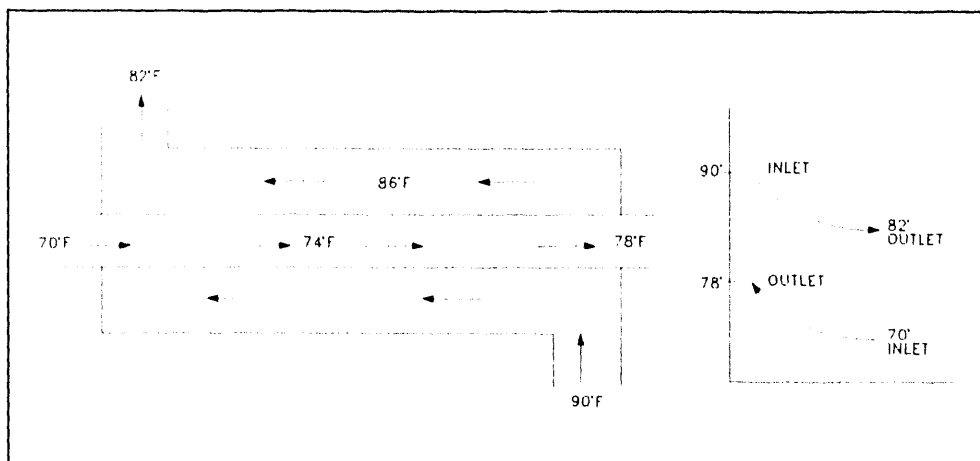

Figure 4 Counter Flow Heat Exchange

Cross flow, as illustrated in Figure 5, exists when one fluid flows perpendicular to the second fluid; that is, one fluid flows through tubes and the second fluid passes around the tubes at 90° angle. Cross flow heat exchangers are usually found in applications where one of the fluids changes state (2-phase flow). An example is a steam system's condenser, in which the steam exiting the turbine enters the condenser shell side, and the cool water flowing in the tubes absorbs the heat from the steam, condensing it into water. Large volumes of vapor may be condensed using this type of heat exchanger flow.

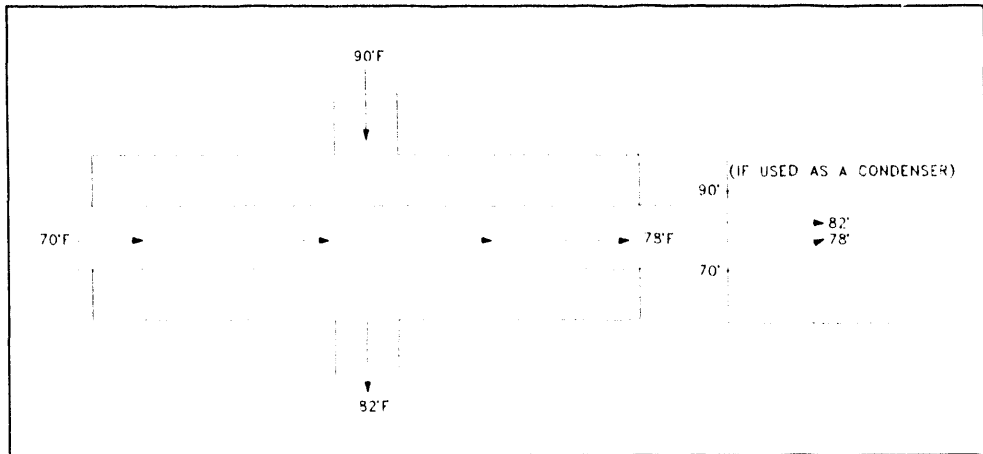

Figure 5 Cross Flow Heat Exchanger

Comparison of the Types of Heat Exchangers

Each of the three types of heat exchangers has advantages and disadvantages. But of the three, the counter flow heat exchanger design is the most efficient when comparing heat transfer rate per unit surface area. The efficiency of a counter flow heat exchanger is due to the fact that the average ΔT (difference in temperature) between the two fluids over the length of the heat exchanger is maximized, as shown in Figure 4. Therefore the log mean temperature for a counter flow heat exchanger is larger than the log mean temperature for a similar parallel or cross flow heat exchanger. (See the Thermodynamics, Heat Transfer, and Fluid Flow Fundamentals Handbook for a review of log mean temperature). This can be seen by comparing the graphs in Figure 3, Figure 4, and Figure 5. The following exercise demonstrates how the higher log mean temperature of the counter flow heat exchanger results in a larger heat transfer rate. The log mean temperature for a heat exchanger is calculated using the following equation.

$$\Delta T_{lm} = \frac{\Delta T_2 - \Delta T_1}{\ln \frac{\Delta T_2}{\Delta T_1}} \quad (2-1)$$

Heat transfer in a heat exchanger is by conduction and convection. The rate of heat transfer, "Q", in a heat exchanger is calculated using the following equation.

$$\dot{Q} = U_o A_o \Delta T_{lm} \quad (2-2)$$

Where:

\dot{Q} = Heat transfer rate (BTU/hr)

U_o = Overall heat transfer coefficient (BTU/hr-ft²-°F)

A_o = Cross sectional heat transfer area (ft²)

ΔT_{lm} = Log mean temperature difference (°F)

Consider the following example of a heat exchanger operated under identical conditions as a counter flow and then a parallel flow heat exchanger.

T_1 = represents the hot fluid temperature

T_{1in} = 200°F

T_{1out} = 145°F

U_o = 70 BTU/hr-ft²-°F

A_o = 75ft²

T_2 = represents the cold fluid temperature

T_{2in} = 80°F

T_{2out} = 120°F

$$\text{Counter flow } \Delta T_{lm} = \frac{(200-120^\circ\text{F}) - (145-80^\circ\text{F})}{\ln \frac{(200-120^\circ\text{F})}{(145-80^\circ\text{F})}} = 72^\circ\text{F}$$

$$\text{Parallel flow } \Delta T_{\ln} = \frac{(200-80^{\circ}\text{F}) - (145-120^{\circ}\text{F})}{\ln \frac{(200-80^{\circ}\text{F})}{(145-120^{\circ}\text{F})}} = 61^{\circ}\text{F}$$

Inserting the above values into heat transfer Equation (2-2) for the counter flow heat exchanger yields the following result.

$$\dot{Q} = \left[70 \frac{\text{BTU}}{\text{hr-ft}^2-\text{F}} \right] (75\text{ft}^2)(72^{\circ}\text{F})$$

$$\dot{Q} = 3.8 \times 10^5 \frac{\text{BTU}}{\text{hr}}$$

Inserting the above values into the heat transfer Equation (2-2) for parallel flow heat exchanger yields the following result.

$$\dot{Q} = \left[70 \frac{\text{BTU}}{\text{hr-ft}^2-\text{F}} \right] (75\text{ft}^2)(61^{\circ}\text{F})$$

$$\dot{Q} = 3.2 \times 10^5 \frac{\text{BTU}}{\text{hr}}$$

The results demonstrate that given the same operating conditions, operating the same heat exchanger in a counter flow manner will result in a greater heat transfer rate than operating in parallel flow.

In actuality, most large heat exchangers are not purely parallel flow, counter flow, or cross flow; they are usually a combination of the two or all three types of heat exchangers. This is due to the fact that actual heat exchangers are more complex than the simple components shown in the idealized figures used above to depict each type of heat exchanger. The reason for the combination of the various types is to maximize the efficiency of the heat exchanger within the restrictions placed on the design. That is, size, cost, weight, required efficiency, type of fluids, operating pressures, and temperatures, all help determine the complexity of a specific heat exchanger.

One method that combines the characteristics of two or more heat exchangers and improves the performance of a heat exchanger is to have the two fluids pass each other several times within a single heat exchanger. When a heat exchanger's fluids pass each other more than once, a heat exchanger is called a *multi-pass heat exchanger*. If the fluids pass each other only once, the heat exchanger is called a *single-pass heat exchanger*. See Figure 6 for an example of both types. Commonly, the multi-pass heat exchanger reverses the flow in the tubes by use of one or more sets of "U" bends in the tubes. The "U" bends allow the fluid to flow back and forth across the length of the heat exchanger. A second method to achieve multiple passes is to insert baffles on the shell side of the heat exchanger. These direct the shell side fluid back and forth across the tubes to achieve the multi-pass effect.

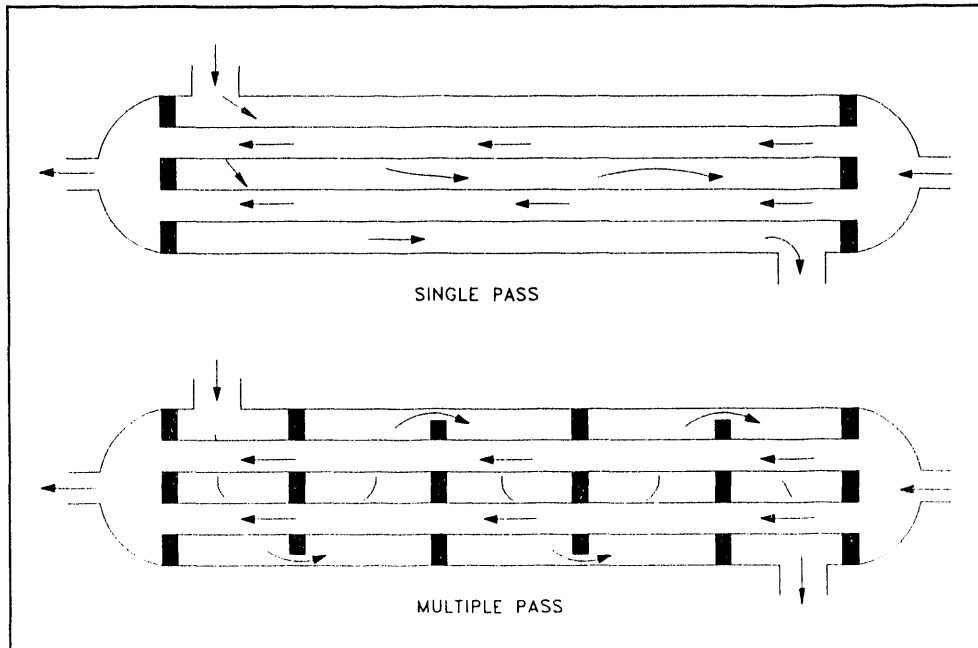

Figure 6 Single and Multi-Pass Heat Exchangers

Heat exchangers are also classified by their function in a particular system. One common classification is regenerative or nonregenerative. A *regenerative* heat exchanger is one in which the same fluid is both the cooling fluid and the cooled fluid, as illustrated in Figure 7. That is, the hot fluid leaving a system gives up its heat to "regenerate" or heat up the fluid returning to the system. Regenerative heat exchangers are usually found in high temperature systems where a portion of the system's fluid is removed from the main process, and then returned. Because the fluid removed from the main process contains energy (heat), the heat from the fluid leaving the main system is used to reheat (regenerate) the returning fluid instead of being rejected to an external cooling medium to improve efficiency. It is important to remember that the term regenerative/nonregenerative only refers to "how" a heat exchanger functions in a system, and does not indicate any single type (tube and shell, plate, parallel flow, counter flow, etc.).

In a *nonregenerative* heat exchanger, as illustrated in Figure 7, the hot fluid is cooled by fluid from a separate system and the energy (heat) removed is not returned to the system.

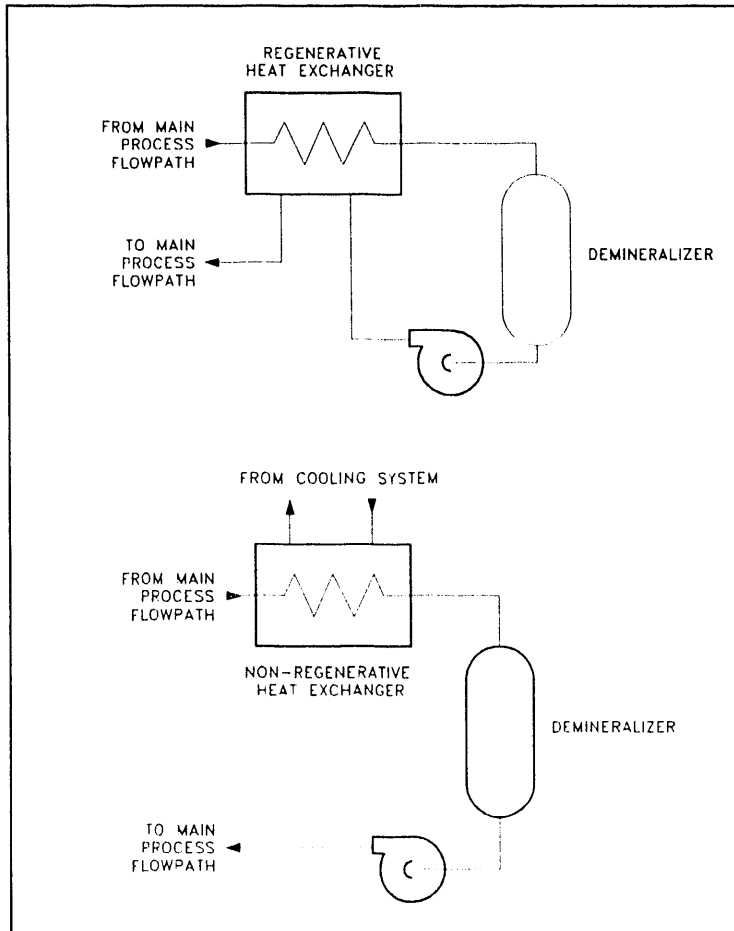

Figure 7 Regenerative and Non-Regenerative Heat Exchangers

Summary

The important information from this chapter is summarized below.

Types of Heat Exchangers Summary

- There are two methods of constructing heat exchangers: plate type and tube type.
- Parallel flow - the hot fluid and the coolant flow in the same direction.
- Counter flow - The hot fluid and the coolant flow in opposite directions.
- Cross flow - the hot fluid and the coolant flow at 90° angles (perpendicular) to each other.
- The four heat exchanger parts identified were:
 - Tubes
 - Tube Sheet
 - Shell
 - Baffles
- Single-pass heat exchangers have fluids that pass each other only once.
- Multi-pass heat exchangers have fluids that pass each other more than once through the use of U tubes and baffles.
- Regenerative heat exchangers use the same fluid for heating and cooling.
- Non-regenerative heat exchangers use separate fluids for heating and cooling.

HEAT EXCHANGER APPLICATIONS

This chapter describes some specific applications of heat exchangers.

- EO 1.5** LIST at least three applications of heat exchangers.
- EO 1.6** STATE the purpose of a condenser.
- EO 1.7** DEFINE the following terms:
- a. Hotwell
 - b. Condensate depression
- EO 1.8** STATE why condensers in large steam cycles are operated at a vacuum.
-

Introduction

Heat exchangers are found in most chemical or mechanical systems. They serve as the system's means of gaining or rejecting heat. Some of the more common applications are found in heating, ventilation and air conditioning (HVAC) systems, radiators on internal combustion engines, boilers, condensers, and as preheaters or coolers in fluid systems. This chapter will review some specific heat exchanger applications. The intent is to provide several specific examples of how each heat exchanger functions in the system, not to cover every possible application.

Preheater

In large steam systems, or in any process requiring high temperatures, the input fluid is usually preheated in stages, instead of trying to heat it in one step from ambient to the final temperature. Preheating in stages increases the plant's efficiency and minimizes thermal shock stress to components, as compared to injecting ambient temperature liquid into a boiler or other device that operates at high temperatures. In the case of a steam system, a portion of the process steam is tapped off and used as a heat source to reheat the feedwater in preheater stages. Figure 8 is an example of the construction and internals of a U-tube feedwater heat exchanger found in a large power generation facility in a preheater stage. As the steam enters the heat exchanger and flows over and around the tubes, it transfers its thermal energy and is condensed. Note that the steam enters from the top into the shell side of the heat exchanger, where it not only transfers sensible heat (temperature change) but also gives up its latent heat of vaporization (condenses steam into water). The condensed steam then exits as a liquid at the bottom of the heat exchanger. The feedwater enters the heat exchanger on the bottom right end and flows into the tubes. Note that most of these tubes will be below the fluid level on the shell side.

This means the feedwater is exposed to the condensed steam first and then travels through the tubes and back around to the top right end of the heat exchanger. After making the 180° bend, the partially heated feedwater is then subjected to the hotter steam entering the shell side.

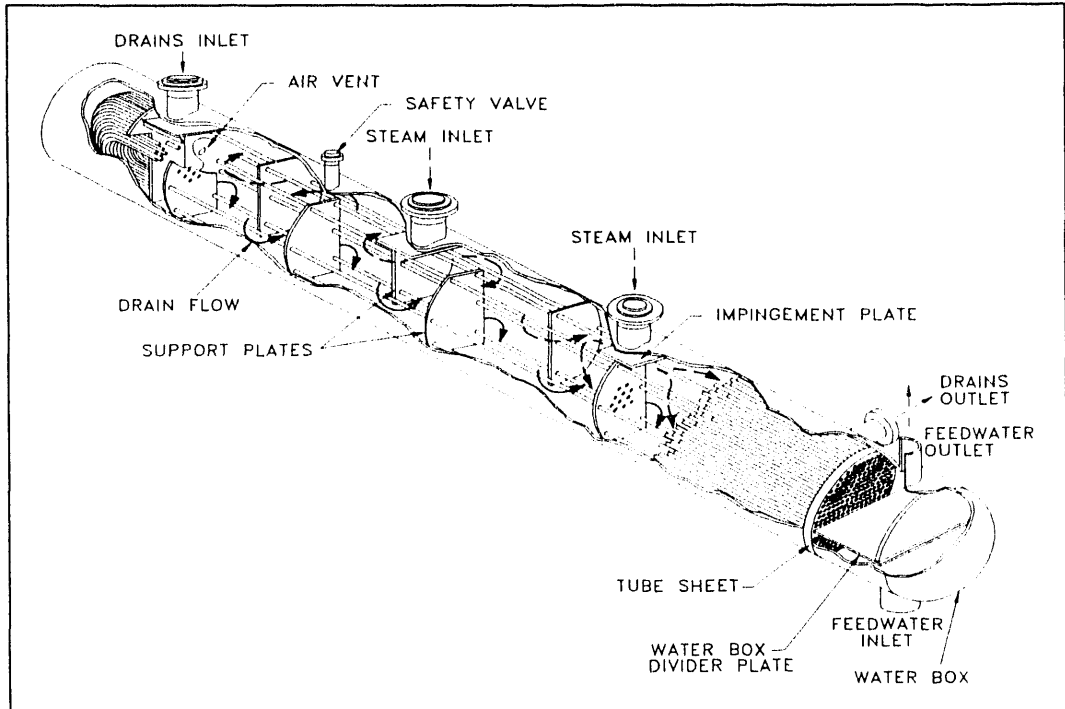

Figure 8 U-tube Feedwater Heat Exchanger

The feedwater is further heated by the hot steam and then exits the heat exchanger. In this type of heat exchanger, the shell side fluid level is very important in determining the efficiency of the heat exchanger, as the shell side fluid level determines the number of tubes exposed to the hot steam.

Radiator

Commonly, heat exchangers are thought of as liquid-to-liquid devices only. But a heat exchanger is any device that transfers heat from one fluid to another. Some of a facility's equipment depend on air-to-liquid heat exchangers. The most familiar example of an air-to-liquid heat exchanger is a car radiator. The coolant flowing in the engine picks up heat from the engine block and carries it to the radiator. From the radiator, the hot coolant flows into the tube side of the radiator (heat exchanger). The relatively cool air flowing over the outside of the tubes picks up the heat, reducing the temperature of the coolant.

Because air is such a poor conductor of heat, the heat transfer area between the metal of the radiator and the air must be maximized. This is done by using fins on the outside of the tubes. The fins improve the efficiency of a heat exchanger and are commonly found on most liquid-to-air heat exchangers and in some high efficiency liquid-to-liquid heat exchangers.

Air Conditioner Evaporator and Condenser

All air conditioning systems contain at least two heat exchangers, usually called the evaporator and the condenser. In either case, evaporator or condenser, the refrigerant flows into the heat exchanger and transfers heat, either gaining or releasing it to the cooling medium. Commonly, the cooling medium is air or water. In the case of the condenser, the hot, high pressure refrigerant gas must be condensed to a subcooled liquid.

The condenser accomplishes this by cooling the gas, transferring its heat to either air or water. The cooled gas then condenses into a liquid. In the evaporator, the subcooled refrigerant flows into the heat exchanger, but the heat flow is reversed, with the relatively cool refrigerant absorbing heat from the hotter air flowing on the outside of the tubes. This cools the air and boils the refrigerant.

Large Steam System Condensers

The steam condenser, shown in Figure 9, is a major component of the steam cycle in power generation facilities. It is a closed space into which the steam exits the turbine and is forced to give up its latent heat of vaporization. It is a necessary component of the steam cycle for two reasons. One, it converts the used steam back into water for return to the steam generator or boiler as feedwater. This lowers the operational cost of the plant by allowing the clean and treated condensate to be reused, and it is far easier to pump a liquid than steam. Two, it increases the cycle's efficiency by allowing the cycle to operate with the largest possible delta-T and delta-P between the source (boiler) and the heat sink (condenser).

Because condensation is taking place, the term latent heat of condensation is used instead of latent heat of vaporization. The steam's latent heat of condensation is passed to the water flowing through the tubes of the condenser.

After the steam condenses, the saturated liquid continues to transfer heat to the cooling water as it falls to the bottom of the condenser, or *hotwell*. This is called subcooling, and a certain amount is desirable. A few degrees subcooling prevents condensate pump cavitation. The difference between the saturation temperature for the existing condenser vacuum and the temperature of the condensate is termed *condensate depression*. This is expressed as a number of degrees condensate depression or degrees subcooled. Excessive condensate depression decreases the operating efficiency of the plant because the subcooled condensate must be reheated in the boiler, which in turn requires more heat from the reactor, fossil fuel, or other heat source.

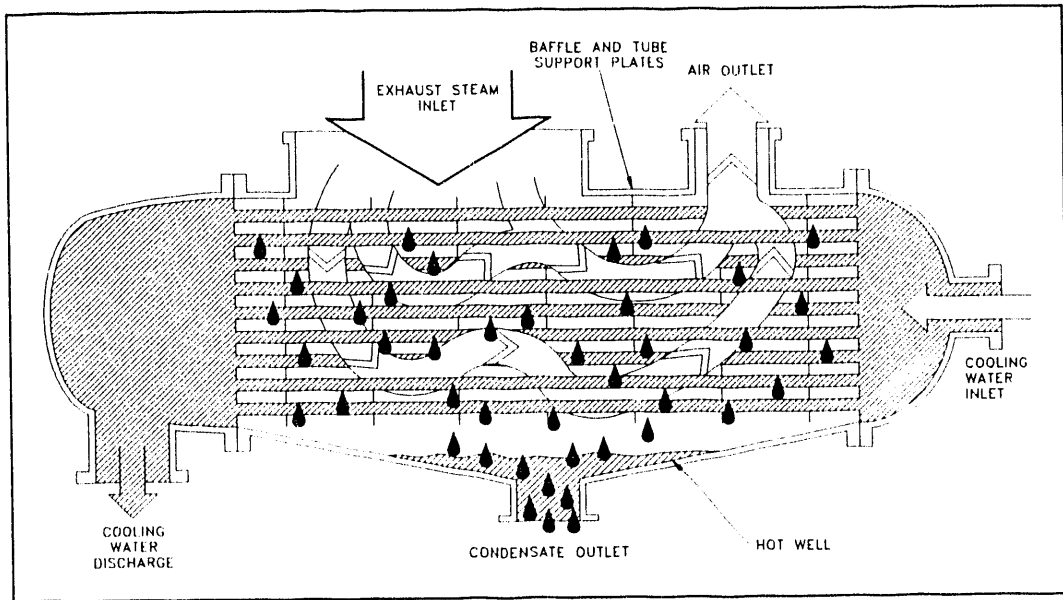

Figure 9 Single-Pass Condenser

There are different condenser designs, but the most common, at least in the large power generation facilities, is the straight-through, single-pass condenser illustrated Figure 9. This condenser design provides cooling water flow through straight tubes from the inlet water box on one end, to the outlet water box on the other end. The cooling water flows once through the condenser and is termed a single pass. The separation between the water box areas and the steam condensing area is accomplished by a tube sheet to which the cooling water tubes are attached. The cooling water tubes are supported within the condenser by the tube support sheets. Condensers normally have a series of baffles that redirect the steam to minimize direct impingement on the cooling water tubes. The bottom area of the condenser is the hotwell, as shown in Figure 9. This is where the condensate collects and the condensate pump takes its suction. If noncondensable gasses are allowed to build up in the condenser, vacuum will decrease and the saturation temperature at which the steam will condense increases.

Non-condensable gasses also blanket the tubes of the condenser, thus reducing the heat transfer surface area of the condenser. This surface area can also be reduced if the condensate level is allowed to rise over the lower tubes of the condenser. A reduction in the heat transfer surface has the same effect as a reduction in cooling water flow. If the condenser is operating near its design capacity, a reduction in the effective surface area results in difficulty maintaining condenser vacuum.

The temperature and flow rate of the cooling water through the condenser controls the temperature of the condensate. This in turn controls the saturation pressure (vacuum) of the condenser.

To prevent the condensate level from rising to the lower tubes of the condenser, a hotwell level control system may be employed. Varying the flow of the condensate pumps is one method used to accomplish hotwell level control. A level sensing network controls the condensate pump speed or pump discharge flow control valve position. Another method employs an overflow system that spills water from the hotwell when a high level is reached.

Condenser vacuum should be maintained as close to 29 inches Hg as practical. This allows maximum expansion of the steam, and therefore, the maximum work. If the condenser were perfectly air-tight (no air or noncondensable gasses present in the exhaust steam), it would be necessary only to condense the steam and remove the condensate to create and maintain a vacuum. The sudden reduction in steam volume, as it condenses, would maintain the vacuum. Pumping the water from the condenser as fast as it is formed would maintain the vacuum. It is, however, impossible to prevent the entrance of air and other noncondensable gasses into the condenser. In addition, some method must exist to initially cause a vacuum to exist in the condenser. This necessitates the use of an air ejector or vacuum pump to establish and help maintain condenser vacuum.

Air ejectors are essentially jet pumps or eductors, as illustrated in Figure 10. In operation, the jet pump has two types of fluids. They are the high pressure fluid that flows through the nozzle, and the fluid being pumped which flows around the nozzle into the throat of the diffuser. The high velocity fluid enters the diffuser where its molecules strike other molecules. These molecules are in turn carried along with the high velocity fluid out of the diffuser creating a low pressure area around the mouth of the nozzle. This process is called entrainment. The low pressure area will draw more fluid from around the nozzle into the throat of the diffuser. As the fluid moves down the diffuser, the increasing area converts the velocity back to pressure. Use of steam at a pressure between 200 psi and 300 psi as the high pressure fluid enables a single-stage air ejector to draw a vacuum of about 26 inches Hg.

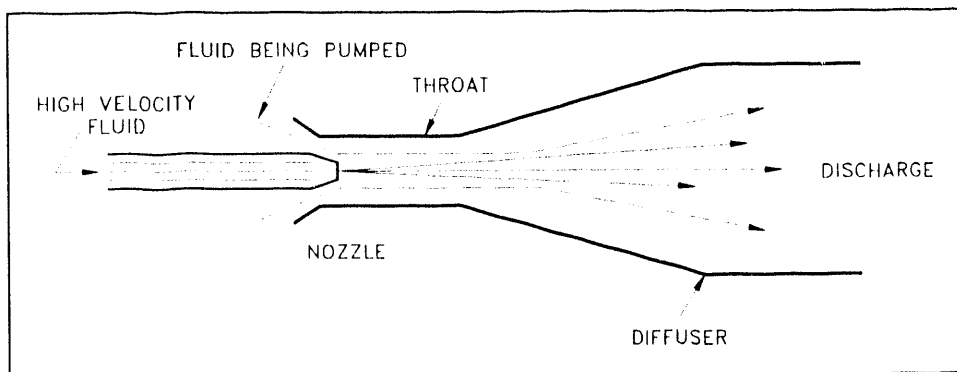

Figure 10 Jet Pump

Normally, air ejectors consist of two suction stages. The first stage suction is located on top of the condenser, while the second stage suction comes from the diffuser of the first stage. The exhaust steam from the second stage must be condensed. This is normally accomplished by an air ejector condenser that is cooled by condensate. The air ejector condenser also preheats the condensate returning to the boiler. Two-stage air ejectors are capable of drawing vacuums to 29 inches Hg.

A vacuum pump may be any type of motor-driven air compressor. Its suction is attached to the condenser, and it discharges to the atmosphere. A common type uses rotating vanes in an elliptical housing. Single-stage, rotary-vane units are used for vacuums to 28 inches Hg. Two stage units can draw vacuums to 29.7 inches Hg. The vacuum pump has an advantage over the air ejector in that it requires no source of steam for its operation. They are normally used as the initial source of vacuum for condenser start-up.

Summary

The important information from this chapter is summarized below.

Heat Exchanger Applications Summary

- Heat exchangers are often used in the following applications.
 - Preheater
 - Radiator
 - Air conditioning evaporator and condenser
 - Steam condenser
- The purpose of a condenser is to remove the latent heat of vaporization, condensing the vapor into a liquid.
- Heat exchangers condense the steam vapor into a liquid for return to the boiler.
- The cycle's efficiency is increased by ensuring the maximum ΔT between the source and the heat sink.
- The hotwell is the area at the bottom of the condenser where the condensed steam is collected to be pumped back into the system feedwater.
- Condensate depression is the amount the condensate in a condenser is cooled below saturation (degrees subcooled).
- Condensers operate at a vacuum to ensure the temperature (and thus the pressure) of the steam is as low as possible. This maximizes the ΔT and ΔP between the source and the heat sink, ensuring the highest cycle efficiency possible.

**Department of Energy
Fundamentals Handbook**

**MECHANICAL SCIENCE
Module 3
Pumps**

TABLE OF CONTENTS

LIST OF FIGURES	ii
LIST OF TABLES	iii
REFERENCES	iv
OBJECTIVES	v
CENTRIFUGAL PUMPS	1
Introduction	1
Diffuser	3
Impeller Classification	3
Centrifugal Pump Classification by Flow	4
Multi-Stage Centrifugal Pumps	6
Centrifugal Pump Components	7
Summary	10
CENTRIFUGAL PUMP OPERATION	11
Introduction	11
Cavitation	12
Net Positive Suction Head	12
Preventing Cavitation	13
Centrifugal Pump Characteristic Curves	14
Centrifugal Pump Protection	15
Gas Binding	15
Priming Centrifugal Pumps	15
Summary	16
POSITIVE DISPLACEMENT PUMPS	18
Introduction	18
Principle of Operation	19
Reciprocating Pumps	19
Rotary Pumps	22
Diaphragm Pumps	26
Positive Displacement Pump Characteristic Curves	27
Positive Displacement Pump Protection	28
Summary	28

LIST OF FIGURES

Figure 1 Centrifugal Pump	2
Figure 2 Single and Double Volutes	2
Figure 3 Centrifugal Pump Diffuser	3
Figure 4 Single Suction and Double Suction Impellers	3
Figure 5 Open, Semi-Open, and Enclosed Impellers	4
Figure 6 Radial Flow Centrifugal Pump	5
Figure 7 Axial Flow Centrifugal Pump	5
Figure 8 Mixed Flow Centrifugal Pump	6
Figure 9 Multi-Stage Centrifugal Pump	7
Figure 10 Centrifugal Pump Components	8
Figure 11 Centrifugal Pump Characteristic Curve	14
Figure 12 Reciprocating Positive Displacement Pump Operation	19
Figure 13 Single-Acting and Double-Acting Pumps	21
Figure 14 Simple Gear Pump	22
Figure 15 Types of Gears Used In Pumps	23
Figure 16 Lobe Type Pump	24
Figure 17 Two-Screw, Low-Pitch, Screw Pump	25
Figure 18 Three-Screw, High-Pitch, Screw Pump	25
Figure 19 Rotary Moving Vane Pump	26
Figure 20 Diaphragm Pump	27
Figure 21 Positive Displacement Pump Characteristic Curve	27

LIST OF TABLES

- None

REFERENCES

- Babcock & Wilcox, Steam, Its Generations and Use, Babcock & Wilcox Co.
- Cheremisinoff, N. P., Fluid Flow, Pumps, Pipes and Channels, Ann Arbor Science.
- General Physics, Heat Transfer, Thermodynamics and Fluid Flow Fundamentals, General Physics Corporation.
- Academic Program for Nuclear Power Plant Personnel, Volume III, Columbia, MD, General Physics Corporation, Library of Congress Card #A 326517, 1982.
- Stewart, Harry L., Pneumatics & Hydraulics, Theodore Audel & Company.

TERMINAL OBJECTIVE

- 1.0 Without references, **DESCRIBE** the purpose, construction, and principles of operation for centrifugal pumps.

ENABLING OBJECTIVES

- 1.1 **STATE** the purposes of the following centrifugal pump components:

- | | |
|-------------|-----------------|
| a. Impeller | d. Packing |
| b. Volute | e. Lantern Ring |
| c. Diffuser | f. Wearing ring |

- 1.2 Given a drawing of a centrifugal pump, **IDENTIFY** the following major components:

- | | |
|-----------------|-----------------------------|
| a. Pump casing | f. Stuffing box gland |
| b. Pump shaft | g. Packing |
| c. Impeller | h. Lantern Ring |
| d. Volute | i. Impeller wearing ring |
| e. Stuffing box | j. Pump casing wearing ring |

- 1.3 **DEFINE** the following terms:

- | | |
|--|-----------------|
| a. Net Positive Suction Head Available | d. Shutoff head |
| b. Cavitation | e. Pump runout |
| c. Gas binding | |

- 1.4 **STATE** the relationship between net positive suction head available and net positive suction head required that is necessary to avoid cavitation.

- 1.5 **LIST** three indications that a centrifugal pump may be cavitating.

- 1.6 **LIST** five changes that can be made in a pump or its surrounding system that can reduce cavitation.

- 1.7 **LIST** three effects of cavitation.

- 1.8 **DESCRIBE** the shape of the characteristic curve for a centrifugal pump.

- 1.9 **DESCRIBE** how centrifugal pumps are protected from the conditions of dead heading and pump runout.

TERMINAL OBJECTIVE

- 2.0 Without references, **DESCRIBE** the purpose, construction, and principle of operation for positive displacement pumps.

ENABLING OBJECTIVES

- 2.1 **STATE** the difference between the flow characteristics of centrifugal and positive displacement pumps.
- 2.2 Given a simplified drawing of a positive displacement pump, **CLASSIFY** the pump as one of the following:
- a. Reciprocating piston pump
 - b. Gear-type rotary pump
 - c. Screw-type rotary pump
 - d. Lobe-type rotary pump
 - e. Moving vane pump
 - f. Diaphragm pump
- 2.3 **EXPLAIN** the importance of viscosity as it relates to the operation of a reciprocating positive displacement pump.
- 2.4 **DESCRIBE** the characteristic curve for a positive displacement pump.
- 2.5 **DEFINE** the term slippage.
- 2.6 **STATE** how positive displacement pumps are protected against overpressurization.

CENTRIFUGAL PUMPS

Centrifugal pumps are the most common type of pumps found in DOE facilities. Centrifugal pumps enjoy widespread application partly due to their ability to operate over a wide range of flow rates and pump heads.

EO 1.1 STATE the purposes of the following centrifugal pump components:

- | | |
|-------------|-----------------|
| a. Impeller | d. Packing |
| b. Volute | e. Lantern Ring |
| c. Diffuser | f. Wearing ring |

EO 1.2 Given a drawing of a centrifugal pump, IDENTIFY the following major components:

- | | |
|-----------------|-----------------------------|
| a. Pump casing | f. Stuffing box gland |
| b. Pump shaft | g. Packing |
| c. Impeller | h. Lantern Ring |
| d. Volute | i. Impeller wearing ring |
| e. Stuffing box | j. Pump casing wearing ring |
-

Introduction

Centrifugal pumps basically consist of a stationary pump casing and an impeller mounted on a rotating shaft. The pump casing provides a pressure boundary for the pump and contains channels to properly direct the suction and discharge flow. The pump casing has suction and discharge penetrations for the main flow path of the pump and normally has small drain and vent fittings to remove gases trapped in the pump casing or to drain the pump casing for maintenance.

Figure 1 is a simplified diagram of a typical centrifugal pump that shows the relative locations of the pump suction, impeller, volute, and discharge. The pump casing guides the liquid from the suction connection, to the center, or eye, of the impeller. The vanes of the rotating *impeller* impart a radial and rotary motion to the liquid, forcing it to the outer periphery of the pump casing where it is collected in the outer part of the pump casing called the volute. The *volute* is a region that expands in cross-sectional area as it wraps around the pump casing. The purpose of the volute is to collect the liquid discharged from the periphery of the impeller at high velocity and gradually cause a reduction in fluid velocity by increasing the flow area. This converts the velocity head to static pressure. The fluid is then discharged from the pump through the discharge connection.

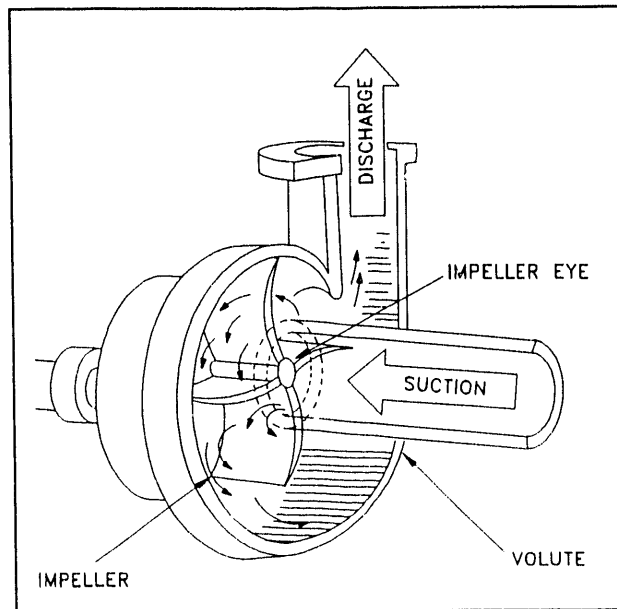

Figure 1 Centrifugal Pump

Centrifugal pumps can also be constructed in a manner that results in two distinct volutes, each receiving the liquid that is discharged from a 180° region of the impeller at any given time. Pumps of this type are called double volute pumps (they may also be referred to as split volute pumps). In some applications the double volute minimizes radial forces imparted to the shaft and bearings due to imbalances in the pressure around the impeller. A comparison of single and double volute centrifugal pumps is shown on Figure 2.

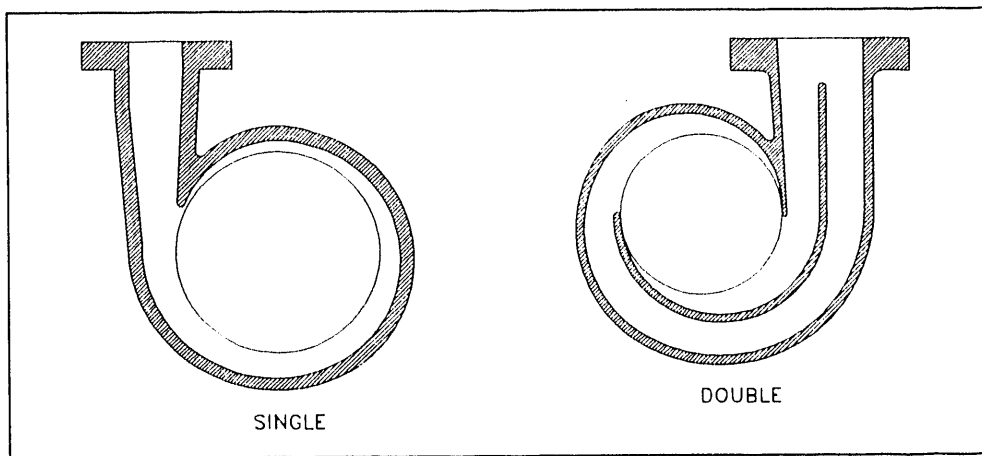

Figure 2 Single and Double Volute

Diffuser

Some centrifugal pumps contain diffusers. A *diffuser* is a set of stationary vanes that surround the impeller. The purpose of the diffuser is to increase the efficiency of the centrifugal pump by allowing a more gradual expansion and less turbulent area for the liquid to reduce in velocity. The diffuser vanes are designed in a manner that the liquid exiting the impeller will encounter an ever-increasing flow area as it passes through the diffuser. This increase in flow area causes a reduction in flow velocity, converting kinetic energy into flow pressure.

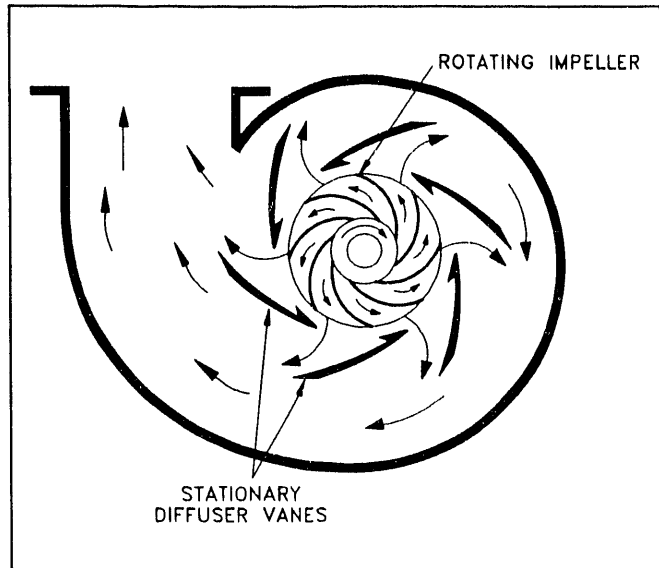

Figure 3 Centrifugal Pump Diffuser

Impeller Classification

Impellers of pumps are classified based on the number of points that the liquid can enter the impeller and also on the amount of webbing between the impeller blades.

Impellers can be either single-suction or double-suction. A single-suction impeller allows liquid to enter the center of the blades from only one direction. A double-suction impeller allows liquid to enter the center of the impeller blades from both sides simultaneously. Figure 4 shows simplified diagrams of single and double-suction impellers.

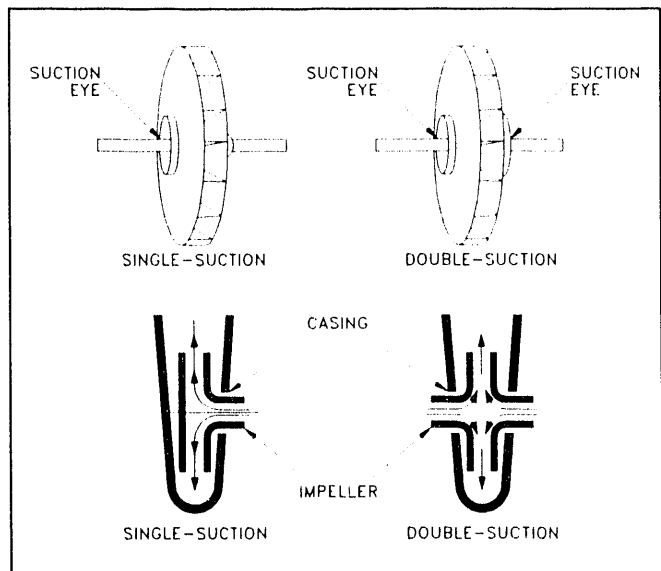

Figure 4 Single-Suction and Double-Suction Impellers

Impellers can be open, semi-open, or enclosed. The open impeller consists only of blades attached to a hub. The semi-open impeller is constructed with a circular plate (the web) attached to one side of the blades. The enclosed impeller has circular plates attached to both sides of the blades. Enclosed impellers are also referred to as shrouded impellers. Figure 5 illustrates examples of open, semi-open, and enclosed impellers.

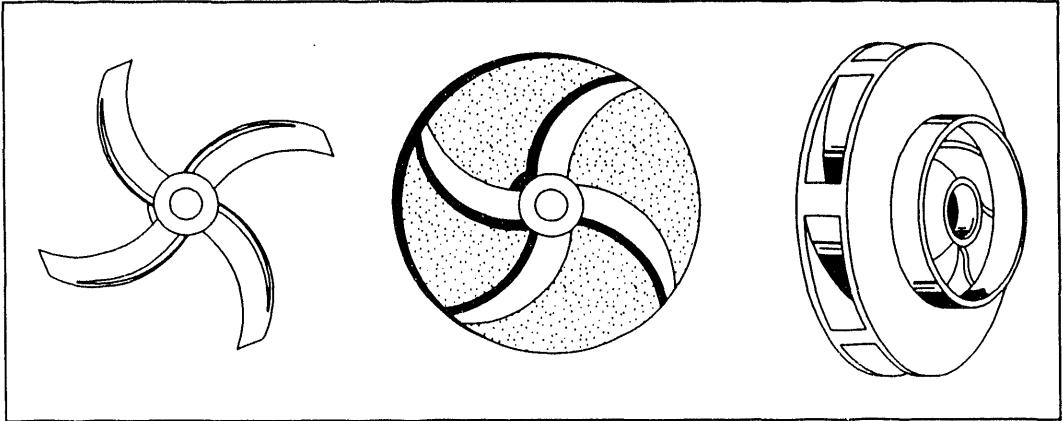

Figure 5 Open, Semi-Open, and Enclosed Impellers

The impeller sometimes contains balancing holes that connect the space around the hub to the suction side of the impeller. The balancing holes have a total cross-sectional area that is considerably greater than the cross-sectional area of the annular space between the wearing ring and the hub. The result is suction pressure on both sides of the impeller hub, which maintains a hydraulic balance of axial thrust.

Centrifugal Pump Classification by Flow

Centrifugal pumps can be classified based on the manner in which fluid flows through the pump. The manner in which fluid flows through the pump is determined by the design of the pump casing and the impeller. The three types of flow through a centrifugal pump are radial flow, axial flow, and mixed flow.

Radial Flow Pumps

In a radial flow pump, the liquid enters at the center of the impeller and is directed out along the impeller blades in a direction at right angles to the pump shaft. The impeller of a typical radial flow pump and the flow through a radial flow pump are shown in Figure 6.

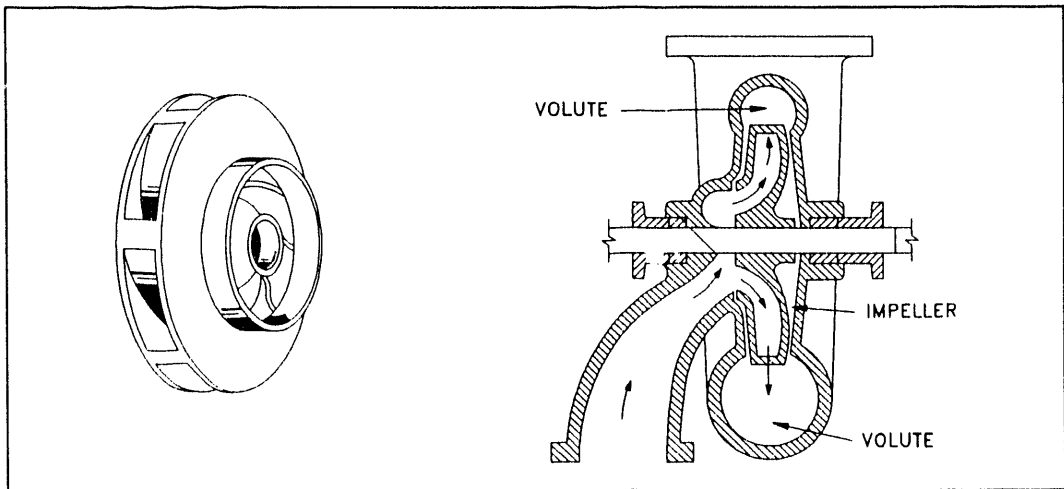

Figure 6 Radial Flow Centrifugal Pump

Axial Flow Pumps

In an axial flow pump, the impeller pushes the liquid in a direction parallel to the pump shaft. Axial flow pumps are sometimes called propeller pumps because they operate essentially the same as the propeller of a boat. The impeller of a typical axial flow pump and the flow through a radial flow pump are shown in Figure 7.

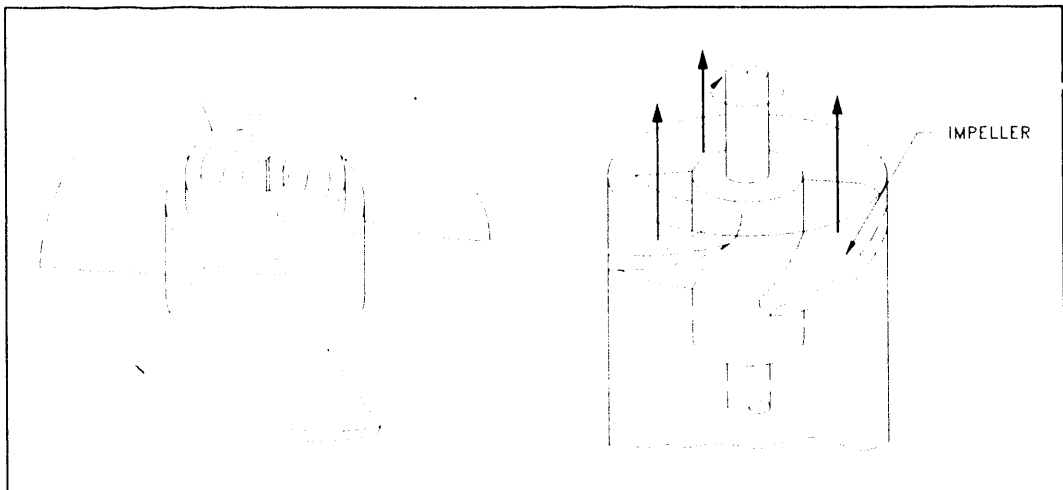

Figure 7 Axial Flow Centrifugal Pump

Mixed Flow Pumps

Mixed flow pumps borrow characteristics from both radial flow and axial flow pumps. As liquid flows through the impeller of a mixed flow pump, the impeller blades push the liquid out away from the pump shaft and to the pump suction at an angle greater than 90° . The impeller of a typical mixed flow pump and the flow through a mixed flow pump are shown in Figure 8.

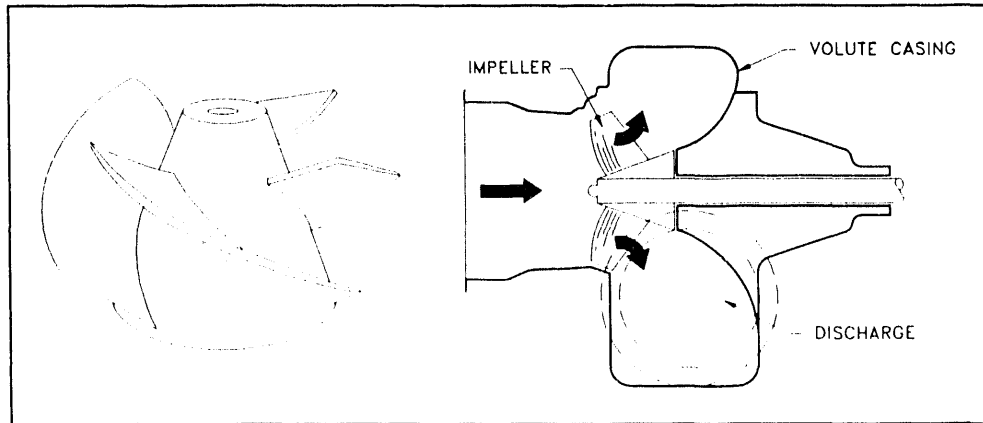

Figure 8 Mixed Flow Centrifugal Pump

Multi-Stage Centrifugal Pumps

A centrifugal pump with a single impeller that can develop a differential pressure of more than 150 psid between the suction and the discharge is difficult and costly to design and construct. A more economical approach to developing high pressures with a single centrifugal pump is to include multiple impellers on a common shaft within the same pump casing. Internal channels in the pump casing route the discharge of one impeller to the suction of another impeller. Figure 9 shows a diagram of the arrangement of the impellers of a four-stage pump. The water enters the pump from the top left and passes through each of the four impellers in series, going from left to right. The water goes from the volute surrounding the discharge of one impeller to the suction of the next impeller.

A *pump stage* is defined as that portion of a centrifugal pump consisting of one impeller and its associated components. Most centrifugal pumps are single-stage pumps, containing only one impeller. A pump containing seven impellers within a single casing would be referred to as a seven-stage pump or, generally, as a multi-stage pump.

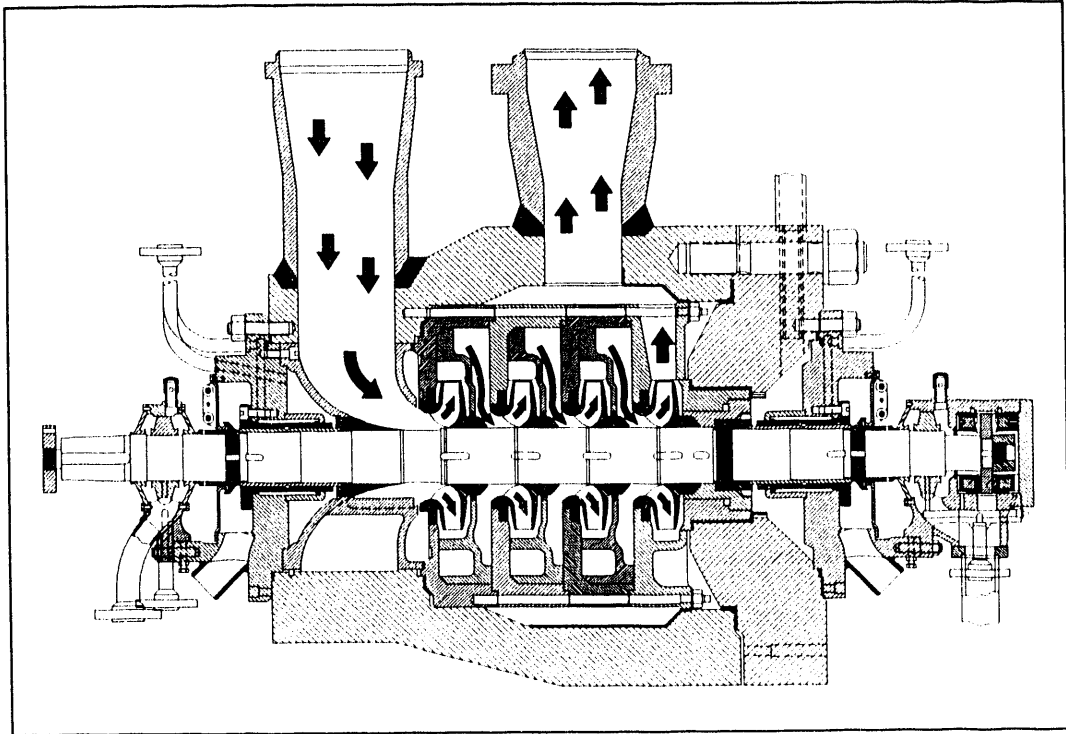

Figure 9 Multi-Stage Centrifugal Pump

Centrifugal Pump Components

Centrifugal pumps vary in design and construction from simple pumps with relatively few parts to extremely complicated pumps with hundreds of individual parts. Some of the most common components found in centrifugal pumps are wearing rings, stuffing boxes, packing, and lantern rings. These components are shown in Figure 10 and described on the following pages.

Wearing Rings

Centrifugal pumps contain rotating impellers within stationary pump casings. To allow the impeller to rotate freely within the pump casing, a small clearance is designed to be maintained between the impeller and the pump casing. To maximize the efficiency of a centrifugal pump, it is necessary to minimize the amount of liquid leaking through this clearance from the high pressure or discharge side of the pump back to the low pressure or suction side.

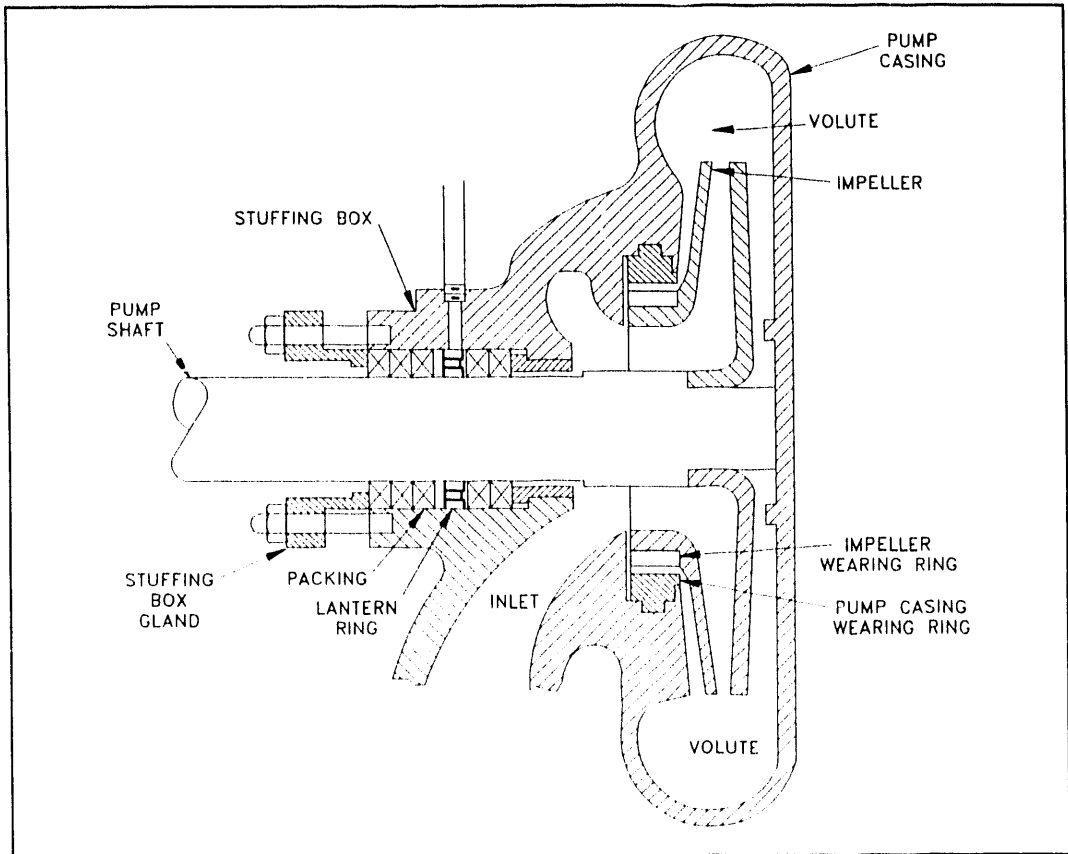

Figure 10 Centrifugal Pump Components

Some wear or erosion will occur at the point where the impeller and the pump casing nearly come into contact. This wear is due to the erosion caused by liquid leaking through this tight clearance and other causes. As wear occurs, the clearances become larger and the rate of leakage increases. Eventually, the leakage could become unacceptably large and maintenance would be required on the pump.

To minimize the cost of pump maintenance, many centrifugal pumps are designed with wearing rings. *Wearing rings* are replaceable rings that are attached to the impeller and/or the pump casing to allow a small running clearance between the impeller and the pump casing without causing wear of the actual impeller or pump casing material. These wearing rings are designed to be replaced periodically during the life of a pump and prevent the more costly replacement of the impeller or the casing.

Stuffing Box

In almost all centrifugal pumps, the rotating shaft that drives the impeller penetrates the pressure boundary of the pump casing. It is important that the pump is designed properly to control the amount of liquid that leaks along the shaft at the point that the shaft penetrates the pump casing. There are many different methods of sealing the shaft penetration of the pump casing. Factors considered when choosing a method include the pressure and temperature of the fluid being pumped, the size of the pump, and the chemical and physical characteristics of the fluid being pumped.

One of the simplest types of shaft seal is the stuffing box. The *stuffing box* is a cylindrical space in the pump casing surrounding the shaft. Rings of packing material are placed in this space. *Packing* is material in the form of rings or strands that is placed in the stuffing box to form a seal to control the rate of leakage along the shaft. The packing rings are held in place by a gland. The gland is, in turn, held in place by studs with adjusting nuts. As the adjusting nuts are tightened, they move the gland in and compress the packing. This axial compression causes the packing to expand radially, forming a tight seal between the rotating shaft and the inside wall of the stuffing box.

The high speed rotation of the shaft generates a significant amount of heat as it rubs against the packing rings. If no lubrication and cooling are provided to the packing, the temperature of the packing increases to the point where damage occurs to the packing, the pump shaft, and possibly nearby pump bearings. Stuffing boxes are normally designed to allow a small amount of controlled leakage along the shaft to provide lubrication and cooling to the packing. The leakage rate can be adjusted by tightening and loosening the packing gland.

Lantern Ring

It is not always possible to use a standard stuffing box to seal the shaft of a centrifugal pump. The pump suction may be under a vacuum so that outward leakage is impossible or the fluid may be too hot to provide adequate cooling of the packing. These conditions require a modification to the standard stuffing box.

One method of adequately cooling the packing under these conditions is to include a lantern ring. A *lantern ring* is a perforated hollow ring located near the center of the packing box that receives relatively cool, clean liquid from either the discharge of the pump or from an external source and distributes the liquid uniformly around the shaft to provide lubrication and cooling. The fluid entering the lantern ring can cool the shaft and packing, lubricate the packing, or seal the joint between the shaft and packing against leakage of air into the pump in the event the pump suction pressure is less than that of the atmosphere.

Mechanical Seals

In some situations, packing material is not adequate for sealing the shaft. One common alternative method for sealing the shaft is with mechanical seals. Mechanical seals consist of two basic parts, a rotating element attached to the pump shaft and a stationary element attached to the pump casing. Each of these elements has a highly polished sealing surface. The polished faces of the rotating and stationary elements come into contact with each other to form a seal that prevents leakage along the shaft.

Summary

The important information in this chapter is summarized below.

Centrifugal Pumps Summary

- The impeller contains rotating vanes that impart a radial and rotary motion to the liquid.
- The volute collects the liquid discharged from the impeller at high velocity and gradually causes a reduction in fluid velocity by increasing the flow area, converting the velocity head to a static head.
- A diffuser increases the efficiency of a centrifugal pump by allowing a more gradual expansion and less turbulent area for the liquid to slow as the flow area expands.
- Packing material provides a seal in the area where the pump shaft penetrates the pump casing.
- Wearing rings are replaceable rings that are attached to the impeller and/or the pump casing to allow a small running clearance between the impeller and pump casing without causing wear of the actual impeller or pump casing material.
- The lantern ring is inserted between rings of packing in the stuffing box to receive relatively cool, clean liquid and distribute the liquid uniformly around the shaft to provide lubrication and cooling to the packing.

CENTRIFUGAL PUMP OPERATION

Improper operation of centrifugal pumps can result in damage to the pump and loss of function of the system that the pump is installed in. It is helpful to know what conditions can lead to pump damage to allow better understanding of pump operating procedures and how the procedures aid the operator in avoiding pump damage.

- EO 1.3 **DEFINE** the following terms:
- | | | | |
|----|-------------------------------------|----|--------------|
| a. | Net Positive Suction Head Available | c. | Gas binding |
| b. | Cavitation | d. | Shutoff head |
| | | e. | Pump runout |
- EO 1.4 **STATE** the relationship between net positive suction head available and net positive suction head required that is necessary to avoid cavitation.
- EO 1.5 **LIST** three indications that a centrifugal pump may be cavitating.
- EO 1.6 **LIST** five changes that can be made in a pump or its surrounding system that can reduce cavitation.
- EO 1.7 **LIST** three effects of cavitation.
- EO 1.8 **DESCRIBE** the shape of the characteristic curve for a centrifugal pump.
- EO 1.9 **DESCRIBE** how centrifugal pumps are protected from the conditions of dead heading and pump runout.
-

Introduction

Many centrifugal pumps are designed in a manner that allows the pump to operate continuously for months or even years. These centrifugal pumps often rely on the liquid that they are pumping to provide cooling and lubrication to the pump bearings and other internal components of the pump. If flow through the pump is stopped while the pump is still operating, the pump will no longer be adequately cooled and the pump can quickly become damaged. Pump damage can also result from pumping a liquid whose temperature is close to saturated conditions.

Cavitation

The flow area at the eye of the pump impeller is usually smaller than either the flow area of the pump suction piping or the flow area through the impeller vanes. When the liquid being pumped enters the eye of a centrifugal pump, the decrease in flow area results in an increase in flow velocity accompanied by a decrease in pressure. The greater the pump flow rate, the greater the pressure drop between the pump suction and the eye of the impeller. If the pressure drop is large enough, or if the temperature is high enough, the pressure drop may be sufficient to cause the liquid to flash to vapor when the local pressure falls below the saturation pressure for the fluid being pumped. Any vapor bubbles formed by the pressure drop at the eye of the impeller are swept along the impeller vanes by the flow of the fluid. When the bubbles enter a region where local pressure is greater than saturation pressure farther out the impeller vane, the vapor bubbles abruptly collapse. This process of the formation and subsequent collapse of vapor bubbles in a pump is called *cavitation*.

Cavitation in a centrifugal pump has a significant effect on pump performance. Cavitation degrades the performance of a pump, resulting in a fluctuating flow rate and discharge pressure. Cavitation can also be destructive to pumps internal components. When a pump cavitates, vapor bubbles form in the low pressure region directly behind the rotating impeller vanes. These vapor bubbles then move toward the oncoming impeller vane, where they collapse and cause a physical shock to the leading edge of the impeller vane. This physical shock creates small pits on the leading edge of the impeller vane. Each individual pit is microscopic in size, but the cumulative effect of millions of these pits formed over a period of hours or days can literally destroy a pump impeller. Cavitation can also cause excessive pump vibration, which could damage pump bearings, wearing rings, and seals.

A small number of centrifugal pumps are designed to operate under conditions where cavitation is unavoidable. These pumps must be specially designed and maintained to withstand the small amount of cavitation that occurs during their operation. Most centrifugal pumps are not designed to withstand sustained cavitation.

Noise is one of the indications that a centrifugal pump is cavitating. A cavitating pump can sound like a can of marbles being shaken. Other indications that can be observed from a remote operating station are fluctuating discharge pressure, flow rate, and pump motor current. Methods to stop or prevent cavitation are presented in the following paragraphs.

Net Positive Suction Head

To avoid cavitation in centrifugal pumps, the pressure of the fluid at all points within the pump must remain above saturation pressure. The quantity used to determine if the pressure of the liquid being pumped is adequate to avoid cavitation is the net positive suction head (NPSH). The *net positive suction head available* ($NPSH_A$) is the difference between the pressure at the suction of the pump and the saturation pressure for the liquid being pumped. The *net positive suction head required* ($NPSH_R$) is the minimum net positive suction head necessary to avoid cavitation.

The condition that must exist to avoid cavitation is that the net positive suction head available must be greater than or equal to the net positive suction head required. This requirement can be stated mathematically as shown below.

$$\text{NPSH}_A \geq \text{NPSH}_R$$

A formula for NPSH_A can be stated as the following equation.

$$\text{NPSH}_A = P_{\text{suction}} - P_{\text{saturation}}$$

When a centrifugal pump is taking suction from a tank or other reservoir, the pressure at the suction of the pump is the sum of the absolute pressure at the surface of the liquid in the tank plus the pressure due to the elevation difference between the surface of liquid in the tank and the pump suction less the head losses due to friction in the suction line from the tank to the pump.

$$\text{NPSH}_A = P_a + P_{st} - h_f - P_{sat}$$

Where:

- NPSH_A = net positive suction head available
- P_a = absolute pressure on the surface of the liquid
- P_{st} = pressure due to elevation between liquid surface and pump suction
- h_f = head losses in the pump suction piping
- P_{sat} = saturation pressure of the liquid being pumped

Preventing Cavitation

If a centrifugal pump is cavitating, several changes in the system design or operation may be necessary to increase the NPSH_A above the NPSH_R and stop the cavitation. One method for increasing the NPSH_A is to increase the pressure at the suction of the pump. For example, if a pump is taking suction from an enclosed tank, either raising the level of the liquid in the tank or increasing the pressure in the space above the liquid increases suction pressure.

It is also possible to increase the NPSH_A by decreasing the temperature of the liquid being pumped. Decreasing the temperature of the liquid decreases the saturation pressure, causing NPSH_A to increase. Recall from the previous module on heat exchangers that large steam condensers usually subcool the condensate to less than the saturation temperature, called condensate depression, to prevent cavitation in the condensate pumps.

If the head losses in the pump suction piping can be reduced, the NPSH_A will be increased. Various methods for reducing head losses include increasing the pipe diameter, reducing the number of elbows, valves, and fittings in the pipe, and decreasing the length of the pipe.

It may also be possible to stop cavitation by reducing the $NPSH_R$ for the pump. The $NPSH_R$ is not a constant for a given pump under all conditions, but depends on certain factors. Typically, the $NPSH_R$ of a pump increases significantly as flow rate through the pump increases. Therefore, reducing the flow rate through a pump by throttling a discharge valve decreases $NPSH_R$. $NPSH_R$ is also dependent upon pump speed. The faster the impeller of a pump rotates, the greater the $NPSH_R$. Therefore, if the speed of a variable speed centrifugal pump is reduced, the $NPSH_R$ of the pump decreases. However, since a pump's flow rate is most often dictated by the needs of the system on which it is connected, only limited adjustments can be made without starting additional parallel pumps, if available.

The net positive suction head required to prevent cavitation is determined through testing by the pump manufacturer and depends upon factors including type of impeller inlet, impeller design, pump flow rate, impeller rotational speed, and the type of liquid being pumped. The manufacturer typically supplies curves of $NPSH_R$ as a function of pump flow rate for a particular liquid (usually water) in the vendor manual for the pump.

Centrifugal Pump Characteristic Curves

For a given centrifugal pump operating at a constant speed, the flow rate through the pump is dependent upon the differential pressure or head developed by the pump. The lower the pump head, the higher the flow rate. A vendor manual for a specific pump usually contains a curve of pump flow rate versus pump head called a pump characteristic curve. After a pump is installed in a system, it is usually tested to ensure that the flow rate and head of the pump are within the required specifications. A typical centrifugal pump characteristic curve is shown in Figure 11.

There are several terms associated with the pump characteristic curve that must be defined. *Shutoff head* is the maximum head that can be developed by a centrifugal pump operating at a set speed. *Pump runout* is the maximum flow that can be developed by a centrifugal pump without damaging the pump. Centrifugal pumps must be designed and operated to be protected from the conditions of pump runout or operating at shutoff head. Additional information may be found in the handbook on Thermodynamics, Heat Transfer, and Fluid Flow.

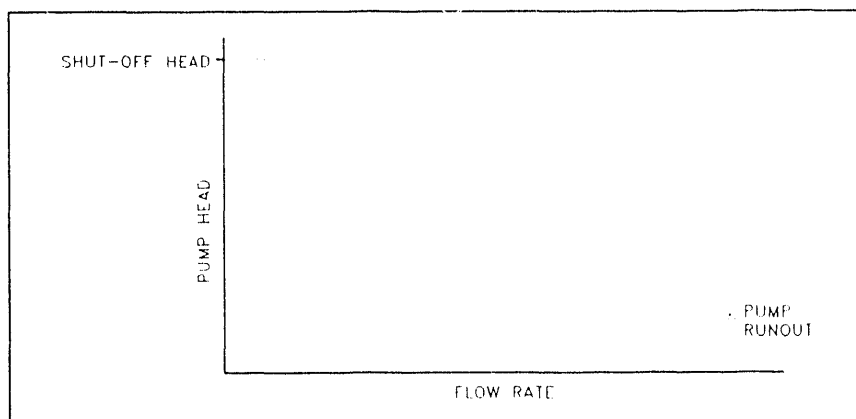

Figure 11 Centrifugal Pump Characteristic Curve

Centrifugal Pump Protection

A centrifugal pump is dead-headed when it is operated with no flow through it, for example, with a closed discharge valve or against a seated check valve. If the discharge valve is closed and there is no other flow path available to the pump, the impeller will churn the same volume of water as it rotates in the pump casing. This will increase the temperature of the liquid (due to friction) in the pump casing to the point that it will flash to vapor. The vapor can interrupt the cooling flow to the pump's packing and bearings, causing excessive wear and heat. If the pump is run in this condition for a significant amount of time, it will become damaged.

When a centrifugal pump is installed in a system such that it may be subjected to periodic shutoff head conditions, it is necessary to provide some means of pump protection. One method for protecting the pump from running dead-headed is to provide a recirculation line from the pump discharge line upstream of the discharge valve, back to the pump's supply source. The recirculation line should be sized to allow enough flow through the pump to prevent overheating and damage to the pump. Protection may also be accomplished by use of an automatic flow control device.

Centrifugal pumps must also be protected from runout. Runout can lead to cavitation and can also cause overheating of the pump's motor due to excessive currents. One method for ensuring that there is always adequate flow resistance at the pump discharge to prevent excessive flow through the pump is to place an orifice or a throttle valve immediately downstream of the pump discharge. Properly designed piping systems are very important to protect from runout.

Gas Binding

Gas binding of a centrifugal pump is a condition where the pump casing is filled with gases or vapors to the point where the impeller is no longer able to contact enough fluid to function correctly. The impeller spins in the gas bubble, but is unable to force liquid through the pump. This can lead to cooling problems for the pump's packing and bearings.

Centrifugal pumps are designed so that their pump casings are completely filled with liquid during pump operation. Most centrifugal pumps can still operate when a small amount of gas accumulates in the pump casing, but pumps in systems containing dissolved gases that are not designed to be self-venting should be periodically vented manually to ensure that gases do not build up in the pump casing.

Priming Centrifugal Pumps

Most centrifugal pumps are not self-priming. In other words, the pump casing must be filled with liquid before the pump is started, or the pump will not be able to function. If the pump casing becomes filled with vapors or gases, the pump impeller becomes gas-bound and incapable of pumping. To ensure that a centrifugal pump remains primed and does not become gas-bound, most centrifugal pumps are located below the level of the source from which the pump is to take its suction. The same effect can be gained by supplying liquid to the pump suction under pressure supplied by another pump placed in the suction line.

Summary

The important information in this chapter is summarized below.

Centrifugal Pump Operation Summary

- There are three indications that a centrifugal pump is cavitating.
 - Noise
 - Fluctuating discharge pressure and flow
 - Fluctuating pump motor current
- Steps that can be taken to stop pump cavitation include:
 - Increase the pressure at the suction of the pump.
 - Reduce the temperature of the liquid being pumped.
 - Reduce head losses in the pump suction piping.
 - Reduce the flow rate through the pump.
 - Reduce the speed of the pump impeller.
- Three effects of pump cavitation are:
 - Degraded pump performance
 - Excessive pump vibration
 - Damage to pump impeller, bearings, wearing rings, and seals
- To avoid pump cavitation, the net positive suction head available must be greater than the net positive suction head required.
- Net positive suction head available is the difference between the pump suction pressure and the saturation pressure for the liquid being pumped.
- Cavitation is the process of the formation and subsequent collapse of vapor bubbles in a pump.
- Gas binding of a centrifugal pump is a condition where the pump casing is filled with gases or vapors to the point where the impeller is no longer able to contact enough fluid to function correctly.
- Shutoff head is the maximum head that can be developed by a centrifugal pump operating at a set speed.

Centrifugal Pump Operation Summary (Cont.)

- Pump runout is the maximum flow that can be developed by a centrifugal pump without damaging the pump.
- The greater the head against which a centrifugal pump operates, the lower the flow rate through the pump. The relationship between pump flow rate and head is illustrated by the characteristic curve for the pump.
- Centrifugal pumps are protected from dead-heading by providing a recirculation from the pump discharge back to the supply source of the pump.
- Centrifugal pumps are protected from runout by placing an orifice or throttle valve immediately downstream of the pump discharge and through proper piping system design.

POSITIVE DISPLACEMENT PUMPS

Positive displacement pumps operate on a different principle than centrifugal pumps. Positive displacement pumps physically entrap a quantity of liquid at the suction of the pump and push that quantity out the discharge of the pump.

- EO 2.1** **STATE** the difference between the flow characteristics of centrifugal and positive displacement pumps.
- EO 2.2** **Given** a simplified drawing of a positive displacement pump, **CLASSIFY** the pump as one of the following:
- a. Reciprocating piston pump
 - b. Gear-type rotary pump
 - c. Screw-type rotary pump
 - d. Lobe-type rotary pump
 - e. Moving vane pump
 - f. Diaphragm pump
- EO 2.3** **EXPLAIN** the importance of viscosity as it relates to the operation of a reciprocating positive displacement pump.
- EO 2.4** **DESCRIBE** the characteristic curve for a positive displacement pump.
- EO 2.5** **DEFINE** the term slippage.
- EO 2.6** **STATE** how positive displacement pumps are protected against overpressurization.
-

Introduction

A positive displacement pump is one in which a definite volume of liquid is delivered for each cycle of pump operation. This volume is constant regardless of the resistance to flow offered by the system the pump is in, provided the capacity of the power unit driving the pump or pump component strength limits are not exceeded. The positive displacement pump delivers liquid in separate volumes with no delivery in between, although a pump having several chambers may have an overlapping delivery among individual chambers, which minimizes this effect. The positive displacement pump differs from centrifugal pumps, which deliver a continuous flow for any given pump speed and discharge resistance.

Positive displacement pumps can be grouped into three basic categories based on their design and operation. The three groups are reciprocating pumps, rotary pumps, and diaphragm pumps.

Principle of Operation

All positive displacement pumps operate on the same basic principle. This principle can be most easily demonstrated by considering a reciprocating positive displacement pump consisting of a single reciprocating piston in a cylinder with a single suction port and a single discharge port as shown in Figure 12. Check valves in the suction and discharge ports allow flow in only one direction.

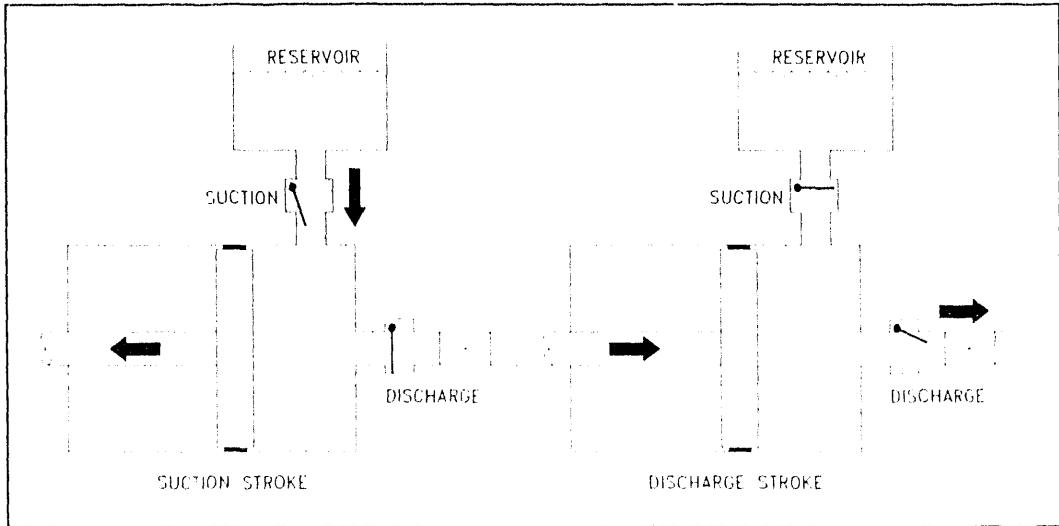

Figure 12 Reciprocating Positive Displacement Pump Operation

During the suction stroke, the piston moves to the left, causing the check valve in the suction line between the reservoir and the pump cylinder to open and admit water from the reservoir. During the discharge stroke, the piston moves to the right, seating the check valve in the suction line and opening the check valve in the discharge line. The volume of liquid moved by the pump in one cycle (one suction stroke and one discharge stroke) is equal to the change in the liquid volume of the cylinder as the piston moves from its farthest left position to its farthest right position.

Reciprocating Pumps

Reciprocating positive displacement pumps are generally categorized in four ways: direct-acting or indirect-acting; simplex or duplex; single-acting or double-acting; and power pumps.

Direct-Acting and Indirect-Acting Pumps

Some reciprocating pumps are powered by prime movers that also have reciprocating motion, such as a reciprocating pump powered by a reciprocating steam piston. The piston rod of the steam piston may be directly connected to the liquid piston of the pump or it may be indirectly connected with a beam or linkage. *Direct-acting* pumps have a plunger on the liquid (pump) end that is directly driven by the pump rod (also the piston rod or extension thereof) and carries the piston of the power end. *Indirect-acting* pumps are driven by means of a beam or linkage connected to and actuated by the power piston rod of a separate reciprocating engine.

Simplex and Duplex Pumps

A *simplex* pump, sometimes referred to as a single pump, is a pump having a single liquid (pump) cylinder. A *duplex* pump is the equivalent of two simplex pumps placed side by side on the same foundation.

The driving of the pistons of a duplex pump is arranged in such a manner that when one piston is on its upstroke the other piston is on its downstroke, and vice versa. This arrangement doubles the capacity of the duplex pump compared to a simplex pump of comparable design.

Single-Acting and Double-Acting Pumps

A *single-acting* pump is one that takes a suction, filling the pump cylinder on the stroke in only one direction, called the suction stroke, and then forces the liquid out of the cylinder on the return stroke, called the discharge stroke. A *double-acting* pump is one that, as it fills one end of the liquid cylinder, is discharging liquid from the other end of the cylinder. On the return stroke, the end of the cylinder just emptied is filled, and the end just filled is emptied. One possible arrangement for single-acting and double-acting pumps is shown in Figure 13.

Power Pumps

Power pumps convert rotary motion to low speed reciprocating motion by reduction gearing, a crankshaft, connecting rods and crossheads. Plungers or pistons are driven by the crosshead drives. Rod and piston construction, similar to duplex double-acting steam pumps, is used by the liquid ends of the low pressure, higher capacity units. The higher pressure units are normally single-acting plungers, and usually employ three (triplex) plungers. Three or more plungers substantially reduce flow pulsations relative to simplex and even duplex pumps.

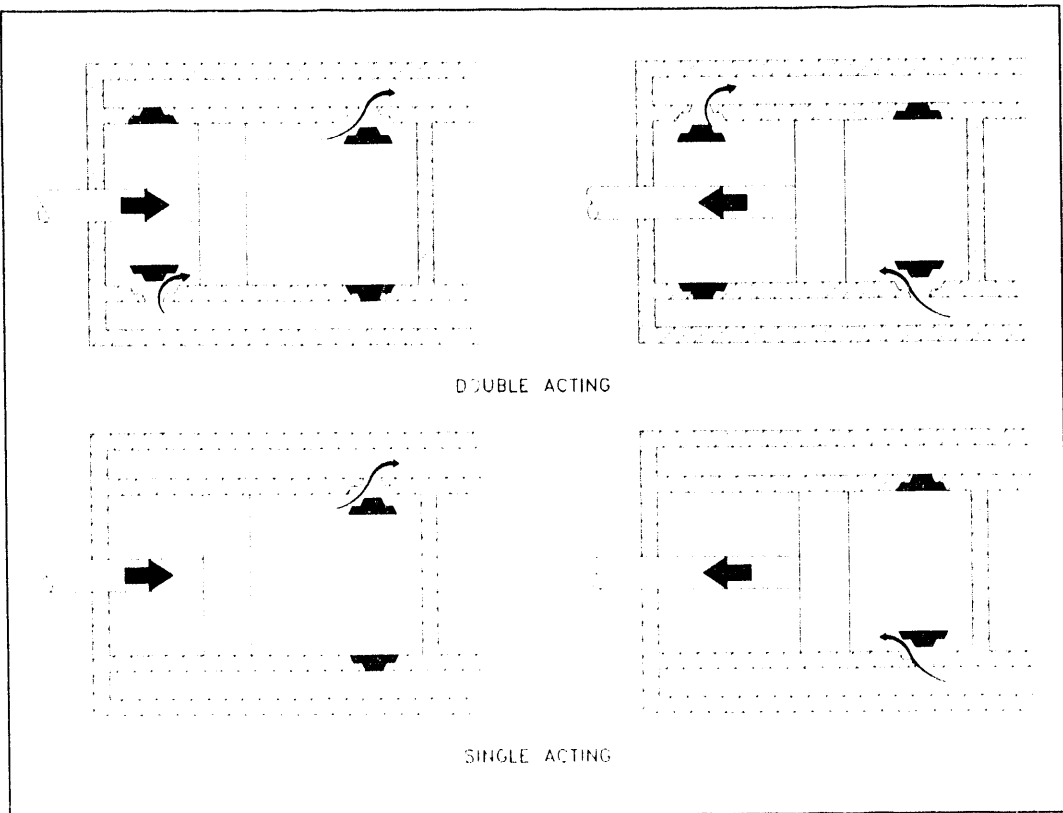

Figure 13 Single-Acting and Double-Acting Pumps

Power pumps typically have high efficiency and are capable of developing very high pressures. They can be driven by either electric motors or turbines. They are relatively expensive pumps and can rarely be justified on the basis of efficiency over centrifugal pumps. However, they are frequently justified over steam reciprocating pumps where continuous duty service is needed due to the high steam requirements of direct-acting steam pumps.

In general, the effective flow rate of reciprocating pumps decreases as the viscosity of the fluid being pumped increases because the speed of the pump must be reduced. In contrast to centrifugal pumps, the differential pressure generated by reciprocating pumps is independent of fluid density. It is dependent entirely on the amount of force exerted on the piston. For more information on viscosity, density, and positive displacement pump theory, refer to the handbook on Thermodynamics, Heat Transfer, and Fluid Flow.

Rotary Pumps

Rotary pumps operate on the principle that a rotating vane, screw, or gear traps the liquid in the suction side of the pump casing and forces it to the discharge side of the casing. These pumps are essentially self-priming due to their capability of removing air from suction lines and producing a high suction lift. In pumps designed for systems requiring high suction lift and self-priming features, it is essential that all clearances between rotating parts, and between rotating and stationary parts, be kept to a minimum in order to reduce slippage. *Slippage* is leakage of fluid from the discharge of the pump back to its suction.

Due to the close clearances in rotary pumps, it is necessary to operate these pumps at relatively low speed in order to secure reliable operation and maintain pump capacity over an extended period of time. Otherwise, the erosive action due to the high velocities of the liquid passing through the narrow clearance spaces would soon cause excessive wear and increased clearances, resulting in slippage.

There are many types of positive displacement rotary pumps, and they are normally grouped into three basic categories that include gear pumps, screw pumps, and moving vane pumps.

Simple Gear Pump

There are several variations of gear pumps. The simple gear pump shown in Figure 14 consists of two spur gears meshing together and revolving in opposite directions within a casing. Only a few thousandths of an inch clearance exists between the case and the gear faces and teeth extremities. Any liquid that fills the space bounded by two successive gear teeth and the case must follow along with the teeth as they revolve. When the gear teeth mesh with the teeth of the other gear, the space between the teeth is reduced, and the entrapped liquid is forced out the pump discharge pipe. As the gears revolve and the teeth disengage, the space again opens on the suction side of the pump, trapping new quantities of liquid and carrying it around the pump case to the discharge. As liquid is carried away from the suction side, a lower pressure is created, which draws liquid in through the suction line.

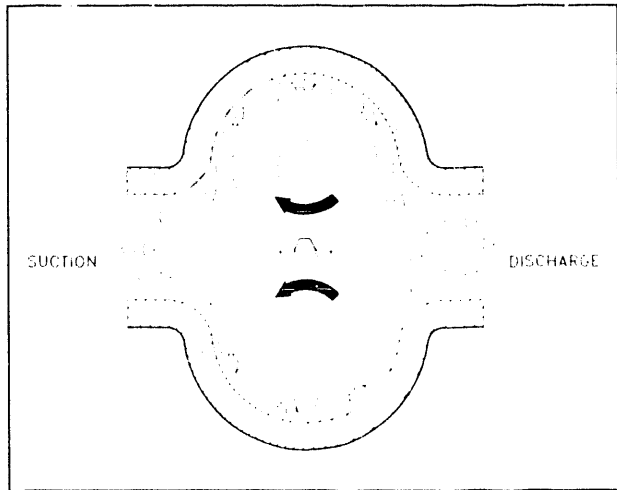

Figure 14 Simple Gear Pump

With the large number of teeth usually employed on the gears, the discharge is relatively smooth and continuous, with small quantities of liquid being delivered to the discharge line in rapid succession. If designed with fewer teeth, the space between the teeth is greater and the capacity increases for a given speed; however, the tendency toward a pulsating discharge increases. In all simple gear pumps, power is applied to the shaft of one of the gears, which transmits power to the driven gear through their meshing teeth.

There are no valves in the gear pump to cause friction losses as in the reciprocating pump. The high impeller velocities, with resultant friction losses, are not required as in the centrifugal pump. Therefore, the gear pump is well suited for handling viscous fluids such as fuel and lubricating oils.

Other Gear Pumps

There are two types of gears used in gear pumps in addition to the simple spur gear. One type is the helical gear. A helix is the curve produced when a straight line moves up or down the surface of a cylinder. The other type is the herringbone gear. A herringbone gear is composed of two helixes spiraling in different directions from the center of the gear. Spur, helical, and herringbone gears are shown in Figure 15.

The helical gear pump has advantages over the simple spur gear. In a spur gear, the entire length of the gear tooth engages at the same time. In a helical gear, the point of engagement moves along the length of the gear tooth as the gear rotates. This makes the helical gear operate with a steadier discharge pressure and fewer pulsations than a spur gear pump.

The herringbone gear pump is also a modification of the simple gear pump. Its principal difference in operation from the simple spur gear pump is that the pointed center section of the space between two teeth begins discharging before the divergent outer ends of the preceding space complete discharging. This overlapping tends to provide a steadier discharge pressure. The power transmission from the driving to the driven gear is also smoother and quieter.

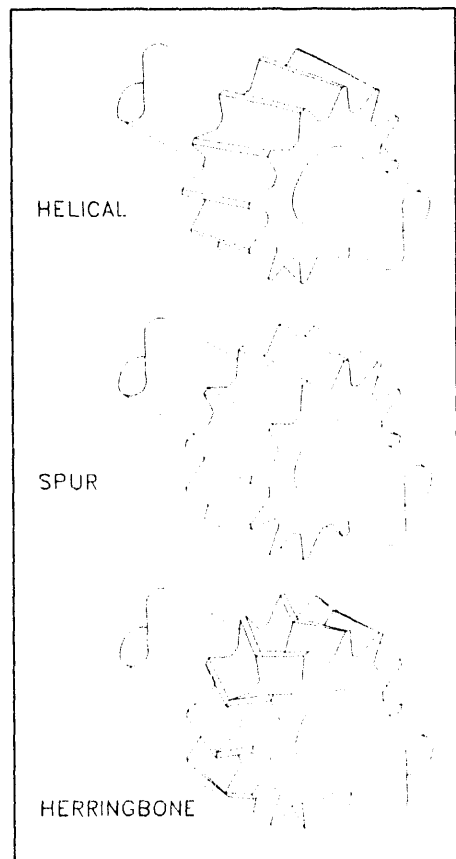

Figure 15 Types of Gears Used in Pumps

Lobe Type Pump

The lobe type pump shown in Figure 16 is another variation of the simple gear pump. It is considered as a simple gear pump having only two or three teeth per rotor; otherwise, its operation or the explanation of the function of its parts is no different. Some designs of lobe pumps are fitted with replaceable gibs, that is, thin plates carried in grooves at the extremity of each lobe where they make contact with the casing. The gib promotes tightness and absorbs radial wear.

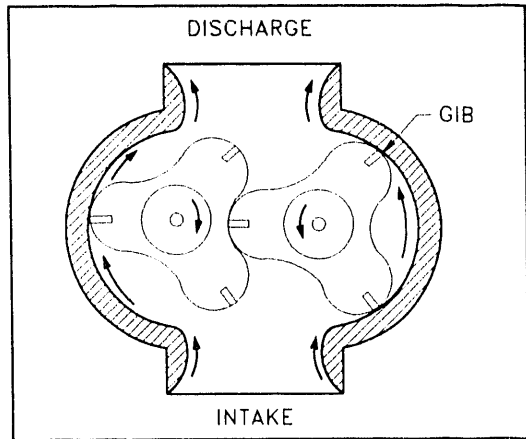

Figure 16 Lobe Type Pump

Screw-Type Positive Displacement Rotary Pump

There are many variations in the design of the screw type positive displacement, rotary pump. The primary differences consist of the number of intermeshing screws involved, the pitch of the screws, and the general direction of fluid flow. Two common designs are the two-screw, low-pitch, double-flow pump and the three-screw, high-pitch, double-flow pump.

Two-Screw, Low-Pitch, Screw Pump

The two-screw, low-pitch, screw pump consists of two screws that mesh with close clearances, mounted on two parallel shafts. One screw has a right-handed thread, and the other screw has a left-handed thread. One shaft is the driving shaft and drives the other shaft through a set of herringbone timing gears. The gears serve to maintain clearances between the screws as they turn and to promote quiet operation. The screws rotate in closely fitting duplex cylinders that have overlapping bores. All clearances are small, but there is no actual contact between the two screws or between the screws and the cylinder walls.

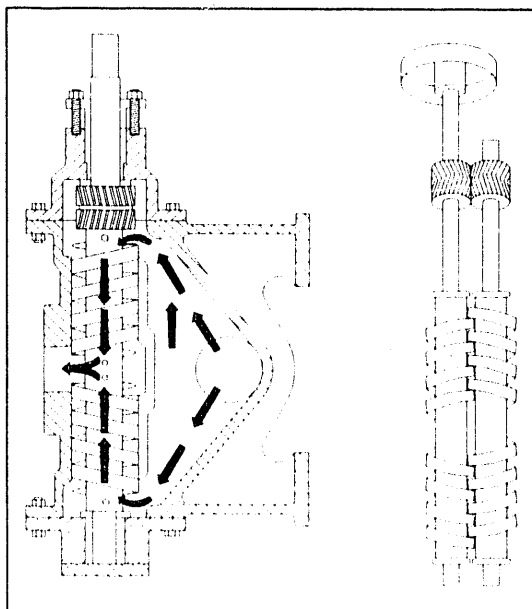

Figure 17 Two-Screw, Low-Pitch, Screw Pump

The complete assembly and the usual flow path are shown in Figure 17. Liquid is trapped at the outer end of each pair of screws. As the first space between the screw threads rotates away from the opposite screw, a one-turn, spiral-shaped quantity of liquid is enclosed when the end of the screw again meshes with the opposite screw. As the screw continues to rotate, the entrapped spiral turns of liquid slide along the cylinder toward the center discharge space while the next slug is being entrapped. Each screw functions similarly, and each pair of screws discharges an equal quantity of liquid in opposed streams toward the center, thus eliminating hydraulic thrust. The removal of liquid from the suction end by the screws produces a reduction in pressure, which draws liquid through the suction line.

Three-Screw, High-Pitch, Screw Pump

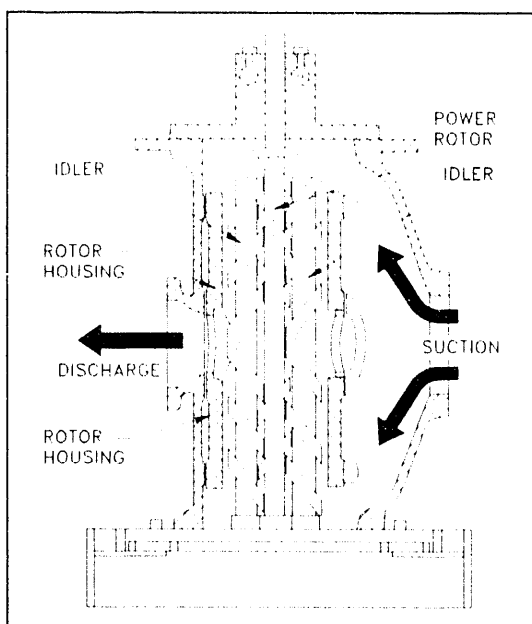

Figure 18 Three-Screw, High-Pitch, Screw Pump

The three-screw, high-pitch, screw pump, shown in Figure 18, has many of the same elements as the two-screw, low-pitch, screw pump, and their operations are similar. Three screws, oppositely threaded on each end, are employed. They rotate in a triple cylinder, the two outer bores of which overlap the center bore. The pitch of the screws is much higher than in the low pitch screw pump; therefore, the center screw, or power rotor, is used to drive the two outer idler rotors directly without external timing gears. Pedestal bearings at the base support the weight of the rotors and maintain their axial position. The liquid being pumped enters the suction opening, flows through passages around the rotor housing, and through the screws from each end, in opposed streams, toward the center discharge. This eliminates unbalanced hydraulic thrust. The screw pump is used for pumping viscous fluids, usually lubricating, hydraulic, or fuel oil.

Rotary Moving Vane Pump

The rotary moving vane pump shown in Figure 19 is another type of positive displacement pump used. The pump consists of a cylindrically bored housing with a suction inlet on one side and a discharge outlet on the other. A cylindrically shaped rotor with a diameter smaller than the cylinder is driven about an axis placed above the centerline of the cylinder. The clearance between rotor and cylinder is small at the top but increases at the bottom. The rotor carries vanes that move in and out as it rotates to maintain sealed spaces between the rotor and the cylinder wall. The vanes trap liquid or gas on the suction side and carry it to the discharge side, where contraction of the space expels it through the discharge line. The vanes may swing on pivots, or they may slide in slots in the rotor.

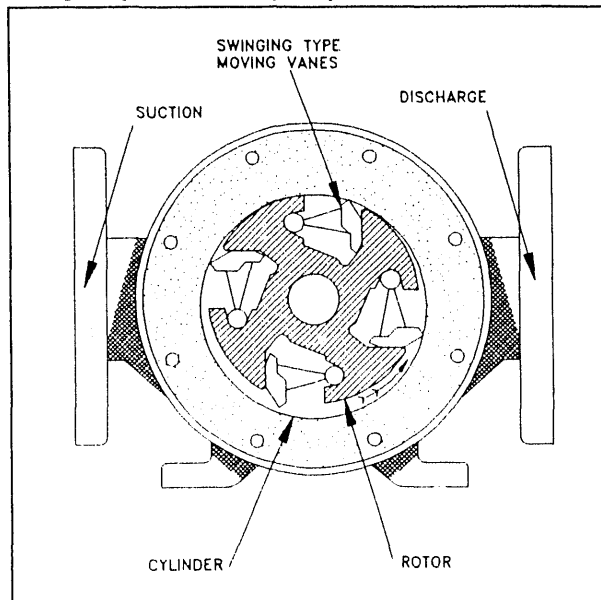

Figure 19 Rotary Moving Vane Pump

Diaphragm Pumps

Diaphragm pumps are also classified as positive displacement pumps because the diaphragm acts as a limited displacement piston. The pump will function when a diaphragm is forced into reciprocating motion by mechanical linkage, compressed air, or fluid from a pulsating, external source. The pump construction eliminates any contact between the liquid being pumped and the source of energy. This eliminates the possibility of leakage, which is important when handling toxic or very expensive liquids. Disadvantages include limited head and capacity range, and the necessity of check valves in the suction and discharge nozzles. An example of a diaphragm pump is shown in Figure 20.

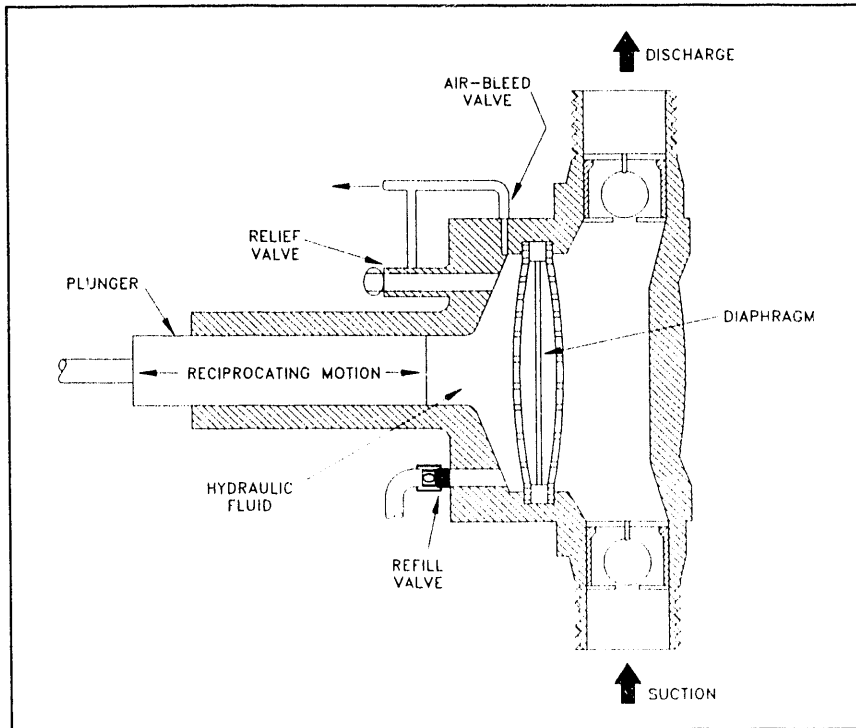

Figure 20 Diaphragm Pump

Positive Displacement Pump Characteristic Curves

Positive displacement pumps deliver a definite volume of liquid for each cycle of pump operation. Therefore, the only factor that effects flow rate in an ideal positive displacement pump is the speed at which it operates. The flow resistance of the system in which the pump is operating will not effect the flow rate through the pump. Figure 21 shows the characteristic curve for a positive displacement pump.

The dashed line in Figure 21 shows actual positive displacement pump performance. This line reflects the fact that as the discharge pressure of the pump increases, some amount of liquid will leak from the discharge of the pump back to the pump suction, reducing the effective flow rate of the pump. The rate at which liquid leaks from the pump discharge to its suction is called *slippage*.

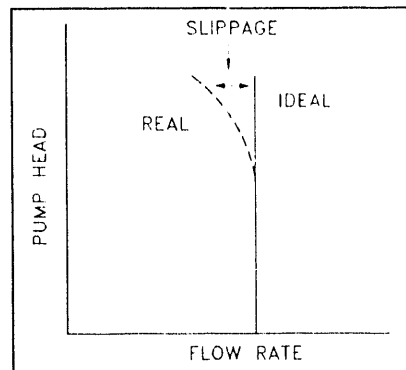

Figure 21
Positive Displacement Pump
Characteristic Curve

Positive Displacement Pump Protection

Positive displacement pumps are normally fitted with relief valves on the upstream side of their discharge valves to protect the pump and its discharge piping from overpressurization. Positive displacement pumps will discharge at the pressure required by the system they are supplying. The relief valve prevents system and pump damage if the pump discharge valve is shut during pump operation or if any other occurrence such as a clogged strainer blocks system flow.

Summary

The important information in this chapter is summarized below.

Positive Displacement Pumps Summary

- The flow delivered by a centrifugal pump during one revolution of the impeller depends upon the head against which the pump is operating. The positive displacement pump delivers a definite volume of fluid for each cycle of pump operation regardless of the head against which the pump is operating.
- Positive displacement pumps may be classified in the following ways:
 - Reciprocating piston pump
 - Gear-type rotary pump
 - Lobe-type rotary pump
 - Screw-type rotary pump
 - Moving vane pump
 - Diaphragm pump
- As the viscosity of a liquid increases, the maximum speed at which a reciprocating positive displacement pump can properly operate decreases. Therefore, as viscosity increases, the maximum flow rate through the pump decreases.
- The characteristic curve for a positive displacement pump operating at a certain speed is a vertical line on a graph of head versus flow.
- Slippage is the rate at which liquid leaks from the discharge of the pump back to the pump suction.
- Positive displacement pumps are protected from overpressurization by a relief valve on the upstream side of the pump discharge valve.

END

**DATE
FILMED**

11 / 16 / 1933

